

## Reference Guide for Microprocessor Controller

Please read and save these instructions for future reference. Read carefully before attempting to assemble, install, operate or maintain the product described. Protect yourself and others by observing all safety information. Failure to comply with these instructions will result in voiding of the product warranty and may result in personal injury and/or property damage.

### DOAS v5.0



Technical Support  
 Call 1-866-478-2574

## Introduction

### Program Features

The microprocessor controller offers control through easy monitoring and adjustment of unit parameters by way of a lighted graphical display and an integral push-button keypad.

### Pre-Programmed Operating Sequences

The controller has been pre-programmed to offer multiple control sequences to provide tempered air. Factory default settings allow for easy setup and commissioning. The sequence parameters are fully adjustable. Refer to the Sequence of Operation for details.

### BMS Communication

The user can remotely adjust set points, view unit status points and alarms. The microprocessor controller is capable of communicating over several protocols:

- BACnet® MSTP
- BACnet® IP
- LonWorks®
- Modbus RTU
- Modbus TCP

Reference Points List for a complete list of BMS points.

### Built-In Occupancy Schedule

The controller has an internal programmable time clock, allowing the user to set occupancy schedules for each day of the week. The controller option also has morning warm-up and cool down capability for improved comfort at the time of occupancy.

### Alarm Management

The microprocessor controller will monitor the unit's status for alarm conditions. Upon detecting an alarm, the controller will record the alarm description, time, date, and input/output status points for user review. A

digital output is reserved for remote alarm indication. Alarms are also communicated via BMS (if equipped).

### Occupancy Modes

The microprocessor controller offers three modes of determining occupancy: a digital input, occupancy schedule or the BMS. If in the unoccupied mode, the unit will either be shut down, continue normal operation utilizing adjustable unoccupied set points, recirculate with unoccupied set points or will cycle on to maintain adjustable unoccupied space temperature and humidity set points (space temperature and humidity sensor is optional).

### Remote Unit Access (if equipped)

The WebUI and Remote Display are two ways to gain access to the unit controller allowing monitoring of the unit and parameter adjustment without being at the unit.

The WebUI can be accessed via a building network and is included with every unit controller. The Remote Display is an LCD to be panel mounted in a remote location and is an option available for purchase.

### WARNING

Electrical shock hazard. Can cause personal injury or equipment damage. Service must be performed only by personnel that are knowledgeable in the operation of the equipment being controlled.

### WARNING

Mechanical high static protection cutoffs must be installed by others to protect the system and equipment from over-pressurization when using factory provided control sensors. The manufacturer does not assume responsibility for this.

## Table of Contents

<b>Sequence of Operation</b> . . . . .	<b>3-9</b>
<b>Controller Overview</b> . . . . .	<b>10-13</b>
<b>Display Use</b> . . . . .	<b>14</b>
<b>Parameter Adjustment</b> . . . . .	<b>14</b>
<b>Web User Interface</b> . . . . .	<b>15</b>
<b>Main Menu</b> . . . . .	<b>16</b>
<b>Unit Status Overview</b> . . . . .	<b>17-20</b>
<b>Unit Enable</b> . . . . .	<b>21</b>
<b>Menu</b>	
Control Variables	
Temp Control . . . . .	21-23
Dehumidification . . . . .	24-25
Refrigeration . . . . .	26
Damper Control . . . . .	26-27
Energy Recovery . . . . .	28
Fan Control . . . . .	29-30
Occupancy . . . . .	31
Advanced . . . . .	32-38
Alarms . . . . .	39
<b>Appendix</b>	
<b>A:</b> Remote Display . . . . .	40
<b>B:</b> I/O Expansion Board Quick Start . . . . .	41
<b>C:</b> Space Thermostat Quick Start . . . . .	42-43
<b>D:</b> GreenTrol® Airflow Monitoring Quick Start . . . . .	44
<b>E:</b> Points List . . . . .	45-56
<b>F:</b> Modbus Connections . . . . .	57
<b>G:</b> Fault Detection and Diagnostics . . . . .	59
<b>Our Commitment</b> . . . . .	Backcover

The microprocessor controller can be configured for air handler, energy recovery, and dedicated outdoor air systems. Each application utilizes similar technologies for heating and cooling: chilled water, hot water, indirect gas, electric heat, and packaged or split DX cooling. All set points, lockouts and delays are user adjustable via the integral keypad display, remote display, or web user interface.

### General Operation

**UNIT START COMMAND:** The microprocessor controller requires a digital input to enable operation. The unit can then be commanded on or off by this digital input, keypad, the BMS or schedule. When a start command becomes active the following steps occur:

- Energy recovery wheel starts, if equipped
- Factory mounted and wired dampers are powered (Outside air, exhaust air, and recirculation air dampers, if equipped)
- Exhaust fan, if equipped, starts after adjustable delay
- Supply fan starts after adjustable delay
- Tempering operation starts after adjustable delay

**UNIT STOP COMMAND:** A shutdown occurs when there is not an occupied or unoccupied start command. The following shutdown methods can occur.

Hard shutdown occurs under the following conditions:

- A user or the BMS disables the system, and the supply temperature is less than the soft shutdown enable set point.
- Occupancy is commanded to unoccupied while there is no unoccupied start command, and the supply temperature is less than the soft shutdown enable set point.

When a hard shutdown occurs:

- The unit shuts down immediately.
- Dampers spring-return to their off position. Damper power is cut 30 sec. after the fans. This allows the fans to slow down prior to spring closing the dampers.

Soft shutdown occurs under the following conditions:

- A user or the BMS disables the system, and the supply temperature is greater than or equal to the soft shutdown enable set point.
- There is no unoccupied or occupied start command and the supply temperature is greater than or equal to the soft shutdown enable set point.

The following occurs during a soft shutdown:

- Tempering outputs immediately revert back to their off value; while
- Dampers remain open and fans continue to run; until
  - The supply air temperature falls below the soft shutdown enable set point minus 5.0°F; or
  - The soft shutdown delay timer has expired.

### UNIT/SYSTEM DISABLED COMMAND:

The unit becomes disabled due to the following:

- The unit was disabled from the controller's Unit Enable screen.
- The unit enable digital input changes to the disabled state.
- The unit was disabled from the BMS.
- The remote start input is in the off position.
- The shutdown input is in the shutdown position.
- A system shutdown alarm was activated.

When disabled the following actions occur:

- The unit shuts down immediately; and
- Dampers spring-return to their off position.

**OCCUPANCY:** The microprocessor controller offers five modes of determining occupancy: digital input, occupancy schedule, BMS, always occupied, or always unoccupied. When in the unoccupied mode, the unit can be configured to shut down, or cycle on to maintain the unoccupied space set points. The unit can be temporarily overridden to the occupied mode via a digital input, keypad display, or space thermostat, if equipped.

#### • Occupied Mode:

- Exhaust fan on, if equipped
- Supply fan on
- Energy Recovery Wheel Control (refer to Energy Recovery Wheel section), if equipped
- Damper Control (refer to Outside Air and Recirculated Air section), if equipped
- Heating (refer to Heating section)
- Cooling (refer to Cooling section)

#### • Unoccupied Mode:

- **Unit Off:** Unit remains off when in unoccupied mode.
- **Normal operation with unoccupied set points:** Unoccupied mode will operate as if in occupied mode but will utilize adjustable unoccupied set points.
  - Exhaust fan on, if equipped
  - Supply fan on
  - Energy Recovery Wheel Control (refer to Energy Recovery Wheel section), if equipped
  - Damper Control (refer to Outside Air and Recirculated Air section), if equipped
  - Heating (refer to Heating section)
  - Cooling (refer to Cooling section)
- **Recirculation with unoccupied set points:** Optional unoccupied mode when there is an unoccupied recirculation damper. The unit will continue to run, but in full recirculation.
  - Supply fan on
  - Recirculation air damper open
  - OA damper closed
  - Tempering operations begin

## Sequence of Operation

- **Night Setback:** Unoccupied mode when there is space temperature and/or humidity sensor(s) connected to the controller. The unit will cycle on to maintain unoccupied space set points if there is a call for unoccupied heating, cooling or dehumidification.
  - Exhaust fan off, if equipped
  - Supply fan on
  - Recirculation air damper open
  - OA damper closed
  - Tempering operations begin

---

### Set Point Control (Occupied)

Supply air temperature set point can be configured as constant, or can be reset by either outside air temperature, or space temperature set point. If equipped with BMS communications, the user can also directly command the temperature set point, if equipped.

- **Outside Air Temperature Reset Function:** The controller will default to supply temperature reset based on OA temperature. The controller will monitor the OA temperature and reset the supply temperature set point based upon the OA reset function.
- **Space temperature Reset:** With a space temperature sensor, the controller will adjust the supply air temperature set point between the min (55°F) and max (90°F), to satisfy the desired space temperature. The temperature set point can be adjusted locally at the microprocessor, the BMS or a space thermostat.

---

### Set Point Control (Unoccupied)

When equipped with an unoccupied recirculation damper and optional space temperature and/or humidity sensors, the unit will cycle on to maintain the unoccupied space set points.

- **Unoccupied Heating:** If equipped with heating, the unit is enabled when the space temperature is less than the unoccupied heating set point minus differential (60°F). The supply air temperature set point will be set to the supply max reset limit (90°F). The unit cycles off when the space temperature reaches the unoccupied heating set point.
- **Unoccupied Cooling:** If equipped with cooling, the unit is enabled when the space temperature is greater than the unoccupied cooling set point plus differential (80°F+5°F). The supply air temperature set point will be set to the supply min reset limit (55°F). The unit cycles off when the space temperature reaches the unoccupied cooling set point.
- **Unoccupied Dehumidification:** If equipped with cooling, the unit is enabled when the space relative humidity exceeds the unoccupied space relative humidity set point plus differential (50%+5%). The supply air temperature set point will be set to the equivalent occupied supply set point.

- **Morning Warm-Up/Cool Down:** At the request to occupy the space, the unit will run using the warm-up or cool down sequence until the occupied set point is achieved. The heating or cooling mode must not be locked out and the space temperature is below or above set point by the unoccupied hysteresis (5°F, adj). This optional sequence requires a space temperature sensor and is field-enabled.

The following steps occur during a morning warm-up/cool down:

- The dampers would be in full recirc if the damper if the damper actuators are not powered (adj) during occupied mode. Otherwise the following is true:
  - Outside air damper is open to minimum OAD position.
  - Recirculation air damper is open at 100% minus OAD position.
- Supply Fan is ON at 100%.
- Exhaust fan is OFF.
- In heating, controls to maintain the maximum supply set point (90°F).
- In cooling, controls to the minimum supply set point (50°F).
- Reheat off.
- Energy recovery wheel off.

---

### Heating

The heating is controlled to maintain the supply temperature set point. The heating will be locked out when the outside air temperature is above the heating lockout (80°F adj).

- **Indirect Gas Furnace:** Microprocessor controller will modulate the indirect gas furnace to maintain the supply temperature set point.
- **Hot Water Coil:** Microprocessor controller will modulate a hot water valve (provided by others) to maintain the supply temperature set point. **Coil freeze protection must be provided by others in the field!**
- **Electric Heater:** Microprocessor controller will modulate an electric heater to maintain the supply temperature set point.

### Cooling

The cooling is controlled to maintain the supply temperature set point. The cooling will be locked out when the outside air temperature is below the cooling lockout (55°F).

- **Chilled Water:** Microprocessor controller will modulate a chilled water valve (provided by others) to maintain supply air set point. Coil freeze protection must be provided by others in the field!
- **Mechanical Cooling:** Microprocessor controller enables stages of cooling to maintain the supply air setpoint. When a modulating compressor is installed (Digital or Inverter Scroll), the compressor modulates to maintain the supply air setpoint. Mechanical cooling is available in the following configurations:
  - **Packaged DX:** Unit with compressors and condensing section located within the same unit. This unit may have lead standard, lead digital scroll, or lead inverter scroll compressors.
  - **Split DX:** Unit with compressors located in the unit and utilizes a remote condenser section. This type of unit may have lead standard, or lead digital scroll compressors.

---

### Active Head Pressure Control

Packaged DX mechanical systems will maintain head pressure control by utilizing transducers on each refrigerant circuit. The pressure reading from the transducer is converted to a saturated discharge temperature for each circuit. The temperature, or maximum temperature when two circuits are present, is compared to a setpoint.

The following sequences are based on the type of condenser fan modulation installed in the unit.

- **No Modulating Fans (All AC):** Condenser fans are staged using digital outputs and the saturated discharge temperature. The first fan stages on with the start of the first compressor. Each additional stage turns on based on the saturated temperature reaching setpoint plus an offset and turns off when the temperature falls below setpoint. Built-in delays between stages assist in staging fans off or on too quickly.
- **Lead Modulating Fan:** A unit with this option has one modulating condenser fan per fan bank. The modulating condenser fan utilizes an analog output to vary the speed of the fan. The modulating fan turns on with the start of the first compressor. When the saturated temperature is above setpoint, the modulating fan speed will increase to maintain head pressure. When below setpoint, the fan speed will decrease.

Additionally, non-modulating fans are staged using digital outputs and an offset. Each additional stage

turns on based on the saturated temperature reaching setpoint plus an offset and turns off when the temperature falls below setpoint. Built-in delays between stages assist in staging fans off or on too quickly.

- **All Modulating Fans:** A unit with this option has all modulating condenser fans. One analog signal modulates all fans in a bank. The first fan stages on with the start of the first compressor. The fans modulate to maintain the saturated discharge temperature setpoint. When the saturated temperature is above setpoint, the fan speed will increase to maintain head pressure. When below setpoint, the fan speed will decrease.

---

### Sliding Head Pressure Control

The head pressure control setpoint changes based on the outside air temperature and an offset. As the outside temperature increases so does the control setpoint for the condenser fans. This feature is active in cooling and dehumidification modes unless disabled in the controller. Sliding head pressure control is enabled by default.

---

### Air Source Heat Pump

When a unit is configured as an ASHP, compressors are used for cooling and heat pump heating. A reversing valve is energized when the unit is in heating mode to reverse the flow of the refrigerant. The ASHP is only available as a packaged unit with an inverter scroll as the lead compressor.

- **Cooling:** Mechanical cooling operates the same as any other unit with compressors by controlling the compressors to maintain the supply air temperature set point in cooling mode and to maintain the cooling coil temperature in dehumidification mode.
  - **Heat Pump Heating:** When heat is required, the reversing valve is switched, and the compressors are staged to maintain the supply air temperature set point.
  - **Heat Pump Heating Lockout:** Heat pump heating may be locked out for any of the following reasons:
    - Defrost is initiated 3 times in one hour.
    - Supply Air temperature is 5°F below set point for more than 10 minutes and secondary heat is available as backup only.
    - Outside ambient temperature is below the HP ambient lockout set point(10°F).
  - **Resetting HP Heating Lockout:** One of the following conditions must occur to return to HP heating:
    - The outside temperature increases by 5°F.
    - The outside humidity decreases by 20%RH, if humidity sensor is installed.
    - The unit has been locked out for more than 2 hours when a humidity sensor is not installed and not locked out on low ambient condition.
  - **Defrost:** Periodically, the ASHP need to initiate a defrost cycle to remove accumulated frost from the outside coil when operating in heating mode. The saturated suction temperature, the outside ambient temperature and/or the outside humidity determine when a defrost initiates and terminates.
- Initiation:** One of the following must be true for a defrost cycle to initiate:
- The saturated suction temperature is less than -15°F; or
  - The saturated suction temperature is less than ambient conditions (temp/dewpoint) minus an offset (35°F/25°F).
- Termination:** The defrost cycle is terminated when one of the following occur:
- The saturated discharge temperatures of all refrigerant circuits are greater than the cancel defrost set point (80°F); or
  - The max defrost time (5 min) has been exceeded.

- **Outside Coil Fan Control:** Head pressure control of the outside fans will maintain head pressure control by utilizing transducers on each refrigerant circuit. The outside fan options available on the ASHP are lead modulating or all modulating fans and utilize refrigerant transducers to stage fans on and off in cooling/dehumidification and heating modes
  - **Cooling/Dehumidification:** Reference the Active Head Pressure Control section of the IOM for operation in cooling and dehumidification modes of operation.
  - **Heating:** In heating mode, the pressure reading from the transducer is converted to a saturated suction temperature for each circuit. The temperature, or minimum temperature when two circuits are present, is compared to a setpoint. When the saturated temperature is below setpoint, the modulating fan speed will increase to maintain head pressure. When above setpoint, the modulating fan speed will decrease. Non-modulating fans, if installed, will stage on and off based on setpoint minus/plus setpoint. This function is similar to the cooling/dehumidification active head pressure control for lead modulating fans.
  - **Defrost:** When defrost is initiated, the outside fans turn off allowing the heat to build and defrost the outside coil. When defrost is terminated, the outside fans turn on to bring the pressure down before switching back to heating mode
- **Secondary Heat:** A secondary heating device may be installed in the unit. This device may be electric heat, gas furnace, or a hot water coil. The following sequences are available for secondary heat:
  - **Backup:** Secondary heat only operates when heat pump heating is not available.
  - **Supplemental:** Secondary heat will operate simultaneously with heat pump heating when the compressors are not producing enough heat to stay within 2°F of set point.

### Economizer

If the application requires cooling, and the OA conditions are suitable for free cooling, the controller will enter economizer mode. If the unit is economizing and the discharge temperature set point is not being met, the controller will bring on mechanical cooling. If equipped with a modulating OA and recirculated air damper, the dampers will modulate between the min OA and max positions to maintain the supply temperature set point. If equipped with an energy wheel, Reference Energy Recovery Wheel Sequence.

- **Temperature:** The economizer will be locked out when:
  - The outside air is greater than the economizer high lockout (65°F).
  - The unit is operating in dehumidification mode.
  - There is a call for heating.
- **Temperature/Enthalpy:** The economizer will be locked out when:
  - The outside air is greater than the economizer high lockout (65°F dry-bulb).
  - The outside air is greater than the economizer high enthalpy lockout (23 btu/lb).
  - The unit is operating in dehumidification mode.
  - There is a call for heating.

---

### Dehumidification

The cooling is controlled to maintain the cold coil set point. Dehumidification is enabled when the OA temperature is greater than the cold coil set point plus an offset (adj. 10°F). Dehumidification is disabled when the OA temperature falls below the enable point by a hysteresis (2°F). If equipped with BMS communications, the user can also directly set the cold coil leaving air set point.

- **Optional Room Relative Humidity Sensor or Thermostat:** The controller will adjust the cold coil leaving air temperature set point between the min (50°F) and max (55°F) set point to satisfy the desired space relative humidity set point.

---

### Reheat

While the unit is dehumidifying, the supply air temperature is maintained by controlling the reheat device to the supply air set point.

- **Hot Gas Reheat (valve):** The microprocessor controller modulates to maintain set point.
  - **Reheat Plus:** The microprocessor controller can be configured to use the primary heat source as secondary reheat.
- 

### Supply Fan VFD Sequence

The factory installed VFD is wired to the controller. Supply fan speed needs to be set during test and balance of the unit. If equipped with BMS communications, the user can also directly command the supply fan speed. The following sequences are selectable for supply fan control. The fan speed is constrained by its min and max speed set points.

- **Constant Volume:** Supply fan operates at a constant speed based on a constant volume set point based on occupancy.
  - **0-10 VDC by Others to VFD:** The supply fan is enabled by the unit controller. An external field-supplied 0-10 VDC signal to the fan's VFD is responsible for modulating the supply fan's speed. The signal is linear and the speed is at min when 0V is present and at max when 10V is present.
  - **CO<sub>2</sub> Control:** The supply fan modulates to maintain CO<sub>2</sub> set point based on a sensor located in the space or return duct. A CO<sub>2</sub> sensor or BMS communicated value is required for this sequence.
  - **Duct Static Pressure Sensor:** The supply fan modulates to maintain an adjustable duct static set point based on a sensor located in the supply duct. A static pressure sensor or BMS communicated value is required for this sequence.
  - **Space Static Pressure:** The supply fan modulates to maintain a space static pressure set point based on a sensor located in the space. A space static pressure sensor or BMS communicated value is required for this sequence.
  - **Single Zone VAV :** The controller will control the supply air temperature and supply fan speed in order to maintain the space temperature.
    - Heating Mode-** The supply temperature set point will be increased before increasing the supply fan speed in order to maintain the space temperature set point. If the calculated supply temperature set point is greater than the current space temperature, the supply fan speed will be increased while the supply temperature set point is increased.
    - Cooling Mode -** The supply temperature set point will be decreased before increasing the supply fan speed in order to maintain the space temperature set point.
-

## Sequence of Operation

The factory installed VFD is wired to the controller. Exhaust fan speed needs to be set during test and balance of the unit. If equipped with BMS communications, the user can also directly command the exhaust fan speed. The following sequences are selectable for exhaust fan control. The fan speed constrained by its min and max speed set points.

- **Constant Volume:** Exhaust fan operates at a constant speed based on a constant volume set point based on occupancy.
- **0-10 VDC by Others to VFD:** The exhaust fan is enabled by the unit controller. An external field-supplied 0-10 VDC signal to the fan's VFD is responsible for modulating the supply fan's speed. The signal is linear and the speed is at min when 0V is present and at max when 10V is present.
- **Space Static Pressure:** The exhaust fan modulates to maintain a space static pressure set point based on a sensor located in the space. A space static pressure sensor or BMS communicated value is required for this sequence.
- **Supply Fan Tracking:** The exhaust fan proportionally modulates based on the supply fan speed plus an adjustable offset.
- **Outside Air Damper Tracking:** The exhaust fan proportionally modulates based on the outdoor air damper modulation. (This sequence requires a modulating outdoor air damper.)

---

### Outside Air and Recirculated (Recirc) Air Damper Control

If equipped with a modulating OA and recirculated air damper, the recirculated air damper will operate inverse of the OA damper. The OA damper opens to its min position. If the controller is configured to modulate the supply fan speed, the min and max OA positions can be reset based on supply fan speed. If equipped with BMS communications, the BMS can directly control the outside damper position. The damper position is constrained by its min and max set point positions.

- **CO<sub>2</sub> Control:** The controller will proportionally modulate the OA/RA dampers based upon a comparison of the CO<sub>2</sub> set point to the actual CO<sub>2</sub> level reported from the sensor. As the CO<sub>2</sub> level rises, the controller will proportionally modulate the OA damper open, between the min OA damper position and max CO<sub>2</sub> position.
  - **Space Static Pressure:** The OA/RA dampers will modulate based upon the signal from a building static pressure sensor. The controller will modulate the dampers, between the min and max OA positions, based upon a comparison of the building static pressure set point to the actual building static pressure level reported from the sensor.
- 

**Economizer:** If the unit is equipped with an energy recovery wheel, the economizer will modulate/stop the energy wheel to achieve free cooling.

- **Stop Wheel:** When economizer mode is enabled and there is a call for cooling, the wheel will stop rotating to allow free cooling. Jog wheel control is available during stop wheel economizer operation. This sequence allows the wheel to rotate for a short period of time exposing a new section to the air stream.
- **Modulate Wheel:** When economizer mode is enabled and there is a call for cooling, the controller modulates wheel speed to maintain the supply temperature set point.
- **Energy Wheel Bypass Dampers, if equipped:** During normal operation, the dampers shall remain closed to allow full operation of the energy wheel. During economizer sequences, the dampers will be open to bypass the energy wheel.

**Frost Control:** The microprocessor controller will activate the frost control method when the OA temperature is less than the defrost set point (5°F) and the wheel pressure switch is closed due to a high wheel pressure drop. Once the pressure drop decreases below the pressure switch point or the OA temperature increases, the unit will resume normal operation.

- **Electric Preheater:** When frosting is occurring, the preheater is energized to defrost the wheel.
  - **Modulate Wheel:** When frosting is occurring, the wheel slows to allow defrosting to occur.
  - **Cycle Wheel:** When frosting is occurring, the energy wheel is cycled off for a defrost cycle time (5 minutes). After the defrost cycle time, the wheel is re-energized to continue normal operation. The controller will not allow another defrost cycle for a min normal operating cycle time (30 minutes).
  - **Timed Exhaust:** When frosting is occurring, the supply fan is cycled off along with the tempering for a defrost cycle time (5 minutes). The exhaust fan will continue to run allowing the warm exhaust air to defrost the wheel. After the defrost cycle time, the supply fan and tempering are re-energized to continue normal operation. The controller will not allow another defrost cycle for a min normal operating cycle time (30 minutes).
-



## Sequence of Operation

The microprocessor controller includes a digital output for remote indication of an alarm condition, which connects via the **J15** port. Alarms include:

- **Dirty Filter Alarm:** If the outside air or return air filter differential pressure rises above the differential pressure switch set point, the microprocessor controller will activate an alarm.
  - **Supply and Exhaust Air Proving Alarm:** Microprocessor controller monitors proving switch on each blower and displays an alarm in case of blower failure.
  - **Sensor Alarm:** Microprocessor controller will send an alarm if a failed sensor is detected (temperature, pressure, relative humidity).
  - **Supply Air Low Limit:** If the supply air temperature drops below the supply air low limit (35°F), the controller disables the unit and activate the alarm output after a preset time delay (300 sec.).
  - **Other Alarms:** Wheel Rotation, High Wheel Pressure, High/Low Refrigerant Pressure.
  - **Condensate Overflow:** Microprocessor controller monitors the float switch installed in the drain pan and will disable the unit and activate an alarm on high condensate.
-

# Large Controller Overview

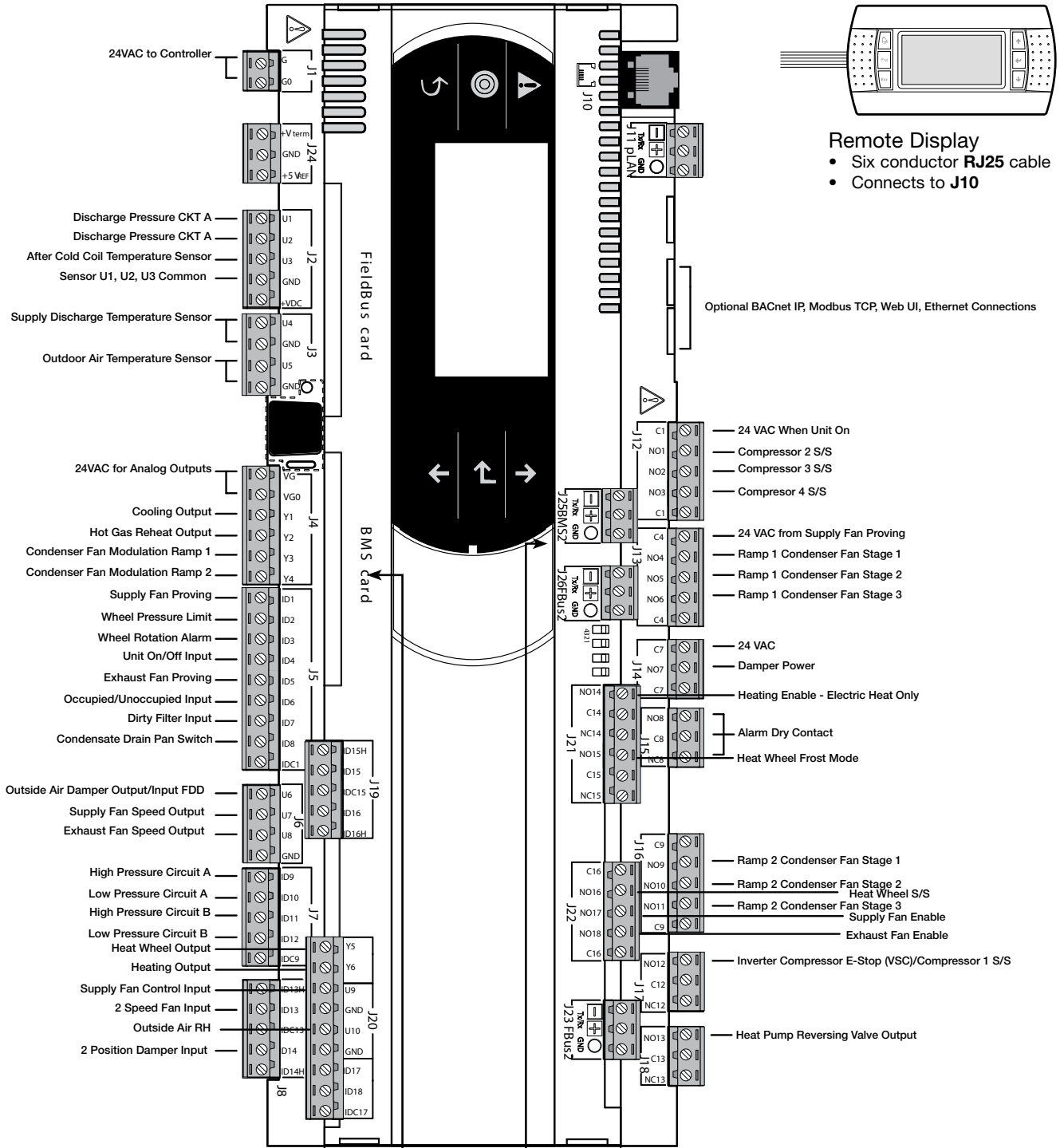

Optional LonWorks cards are located in BMS Card port.

Optional Modbus RTU/BACnet MSTP connections are made to the J25 BMS2 terminal.

# Medium Controller Overview

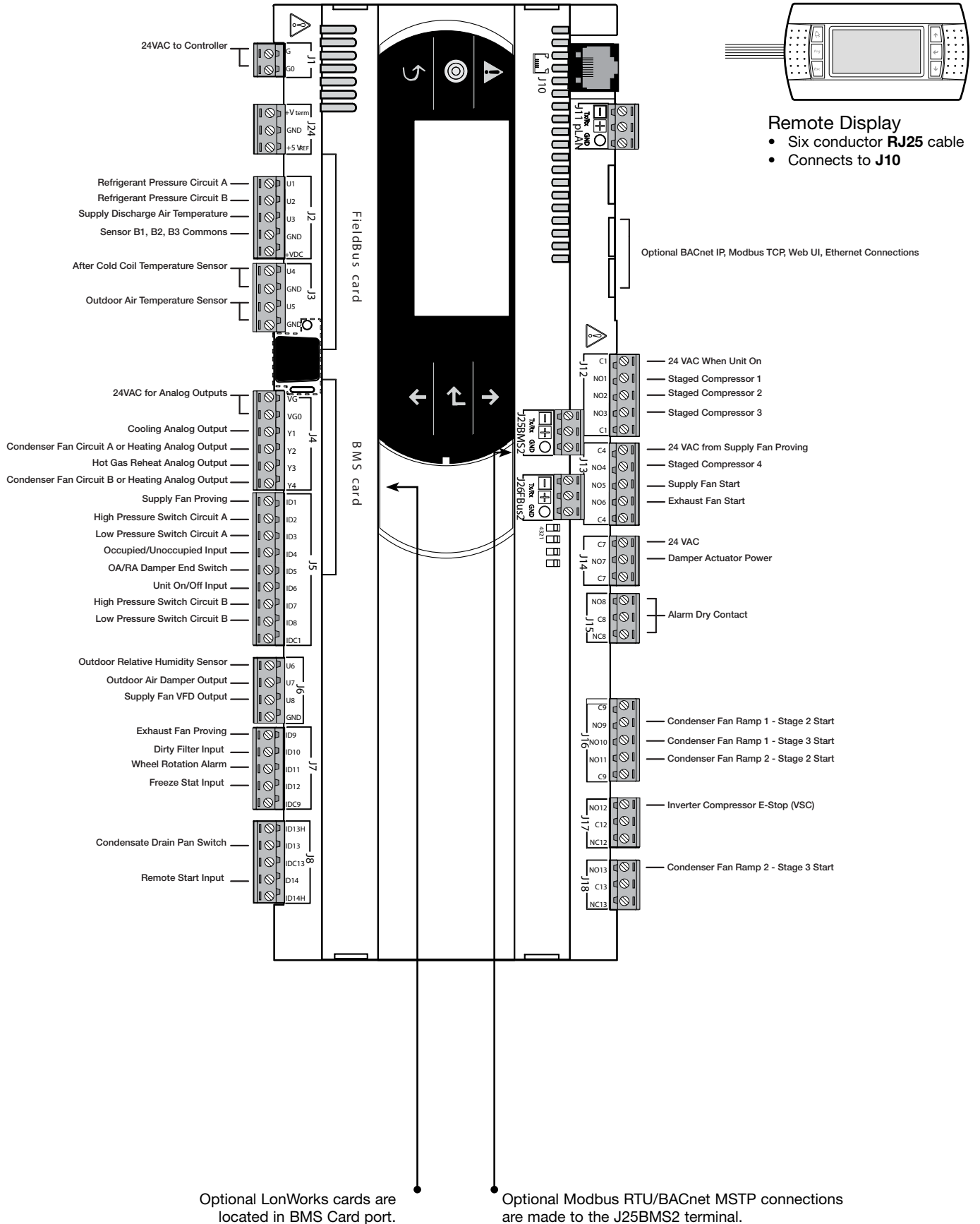

## c.pCOe - Expansion Board Overview, Large Controller Arrangement

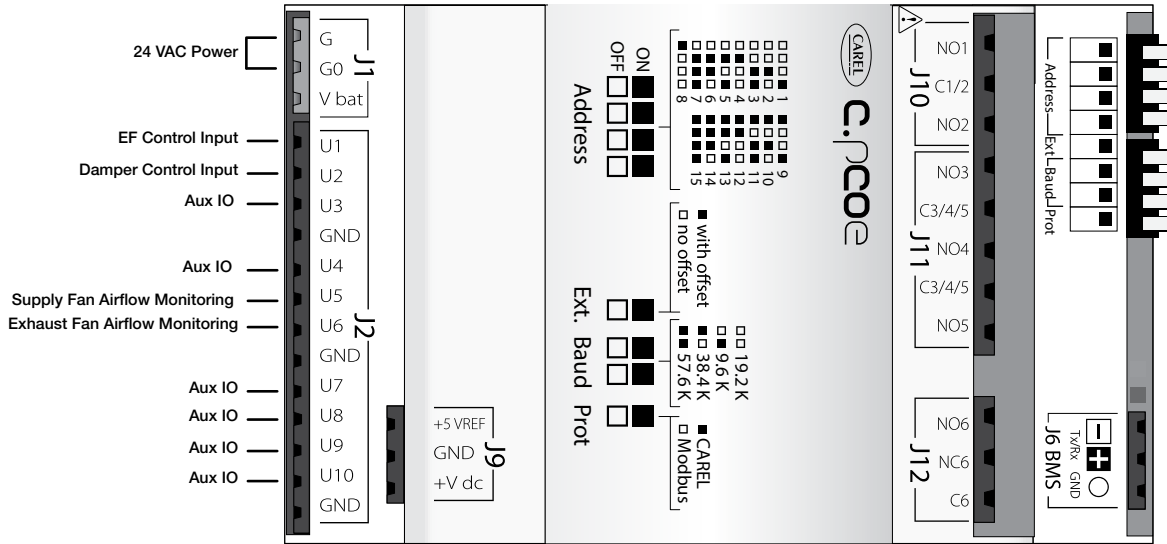

The expansion board is an I/O module than can be used to monitor additional statuses or provide commands from large board controller.

## c.pCOe - Expansion Board Overview, Medium Controller Arrangement

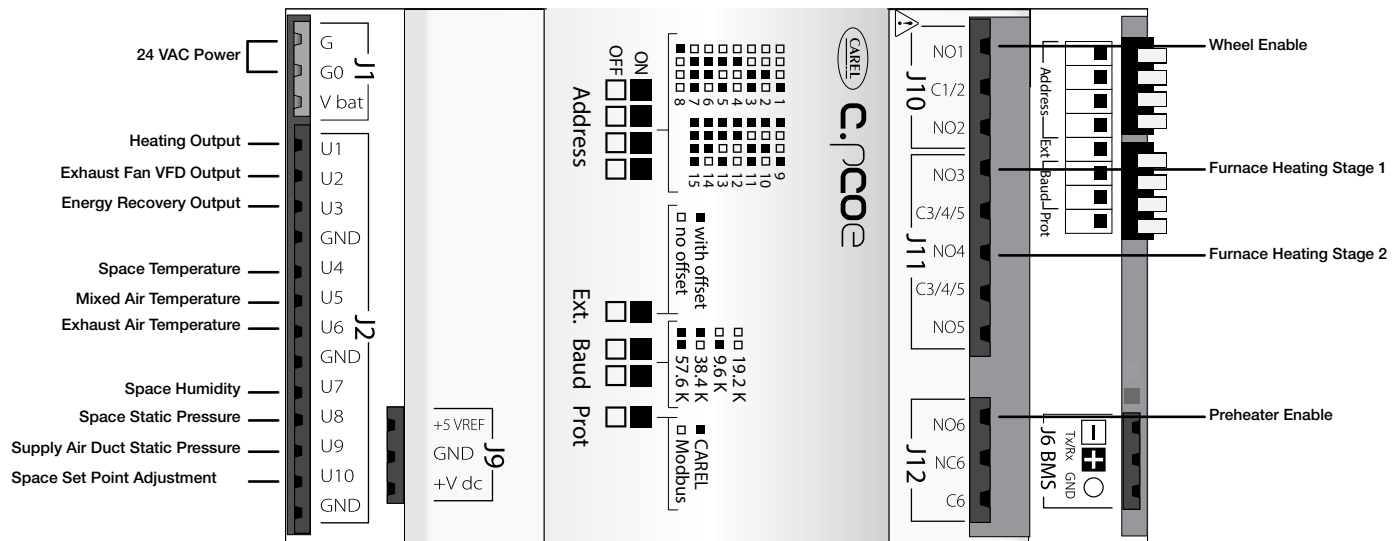

The expansion board is an I/O module than can be used to monitor additional statuses or provide commands from medium board controller.

## pCOe - 4:1 Furnace Overview

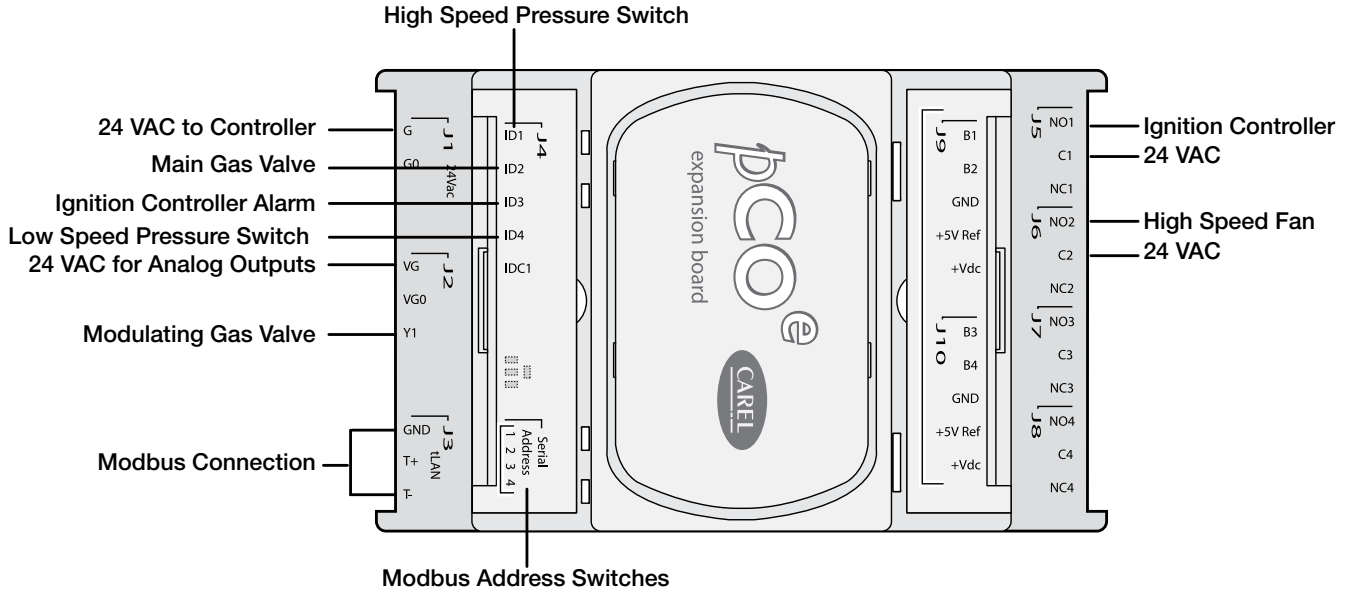



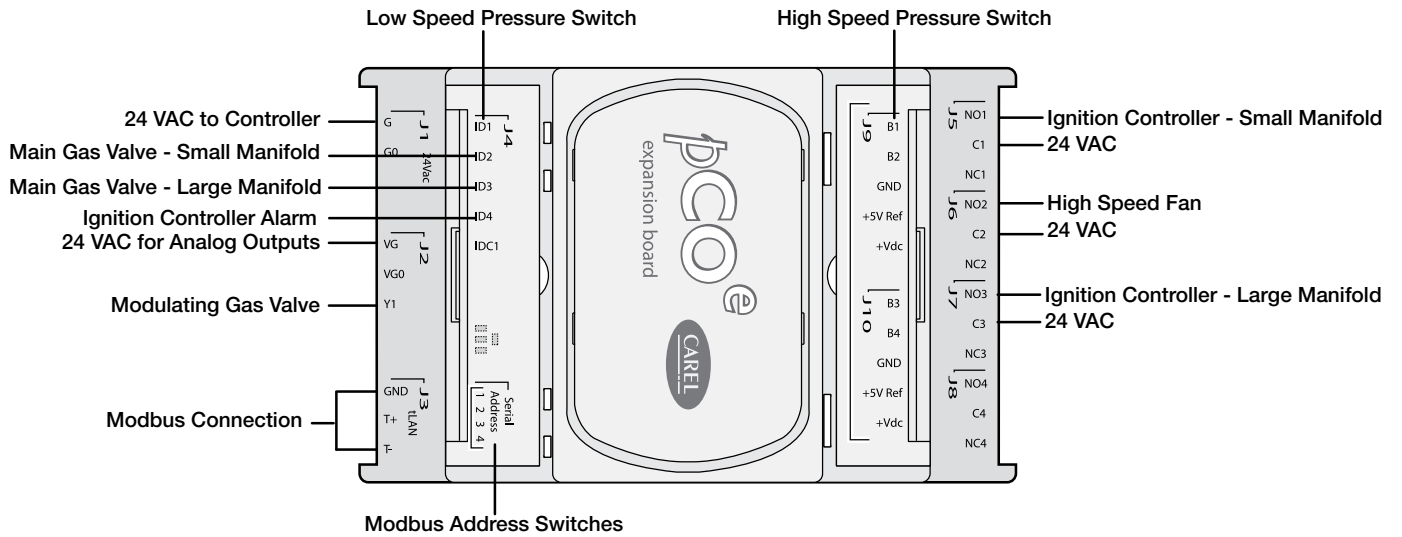



## pCOe - High Turndown Furnace



## Display Use

The microprocessor controller is located in the unit control center. The face of the controller has six buttons, allowing the user to view unit conditions and alter parameters. The microprocessor controller is pre-programmed with easy to use menus. A remote display is also available, which connects via the **J10** port with six wire patch.

Keypad Description		
Button	Description	Functions
	Main Menu	Press to go directly to the Main Menu from any screen. From the Main Menu, navigate to the following screens: <ul style="list-style-type: none"> <li>• Unit Enable</li> <li>• Unit Status</li> <li>• Ctrl Variables</li> <li>• Alarm Menu</li> </ul>
	Alarm	The Alarm button flashes when there is an active alarm. Press to view alarms. Press twice to go to the alarms reset screen.
	Escape	Press from the Main Menu to view the Unit Status screen. Press to go back one menu level.
	Up	Press to navigate through the menus/screens. Press after entering a variable to increase a current value.
	Enter	Press to enter a highlighted menu or screen item. Press to enter a writable variable and press again to confirm the new variable value.
	Down	Press to navigate menus/screens. Press after entering a variable to decrease the current value.
<div style="display: flex; justify-content: space-around; width: 100%;"> <div style="border: 1px solid gray; padding: 2px; font-size: 8px;">2 Button Click</div> <div style="border: 1px solid gray; padding: 2px; font-size: 8px;">2 Button Hold</div> </div>		Unit display on web interface only. These two buttons on the virtual keypad/display are used to simulate two-button actions on the handheld keypad/display.  To simulate pressing two buttons simultaneously: <ol style="list-style-type: none"> <li>1. Click on 2-Button Click.</li> <li>2. Then, sequentially click on two keypad buttons (Main, Alarm, Escape, Up, Enter, Down).</li> </ol> To simulate pressing and holding two buttons simultaneously: <ol style="list-style-type: none"> <li>1. Click on 2-Button Hold.</li> <li>2. Then, sequentially click on two keypad buttons (Main, Alarm, Escape, Up, Enter, Down).</li> </ol>

## Parameter Adjustment

**Supply air low limit**

Alarm when supply is below: 35.0° F



Alarm delay: 300s

The cursor always begins in the upper left corner of the display and will be blinking. Press the  button to move the cursor down for parameter adjustment.

**Supply air low limit**

Alarm when supply is below: 32.0° F

Alarm delay: 300s

Once the cursor has reached the desired parameter, press the   buttons to adjust the value.

**Supply air low limit**

Alarm when supply is below: 32.0° F

Alarm delay: 300s

When satisfied with the adjustment, press the  button to save the parameter. When finished, make certain the cursor is in the upper left corner. If the cursor is not in the upper left corner, the changes will not be saved. The cursor must be in the upper left corner to enable screen advancement.

## Web User Interface

The Web User Interface allows access to the unit controller through the building network. Reference Ctrl Variables/Advanced/Network Settings to set the IP network protocol. Once proper communication is established, the user can click on the follow tabs:

**Overview** – Includes a functioning unit graphic, monitoring points, and active set point adjustment.

**Alarms** – Shows current and cleared alarms.

**Trending** – User can view past and present controller points.

**Information** – Provides manufacturer support information as well as IOM resources.

**Service** – User must be logged with service access criteria (9998). Once proper login is established, the user can view configured input/output points associated with the unit controller

### Pop-Up Tools

**Live Trend** - User can see current values from the controller. The list of variables available is preselected based on the configuration of the unit.

**Unit Display** - Mimics the unit controller display. Allows the user full access to the controller without having to physically be at the unit.

**Dewpoint Calculator** - A calculator with three sliders to determine the dew point, temperature, or humidity. Two of the three values are necessary to get the third.

**Upgrade Application** - A new application program can be loaded to the controller via the WebUI.

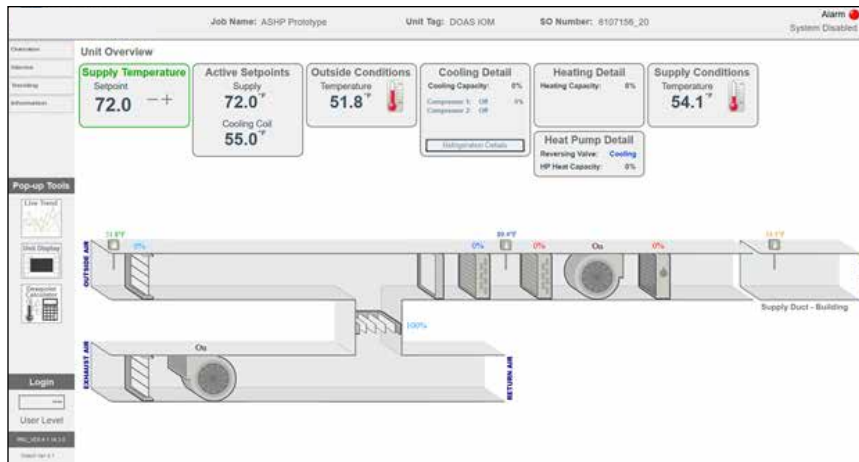

**Web User Interface**

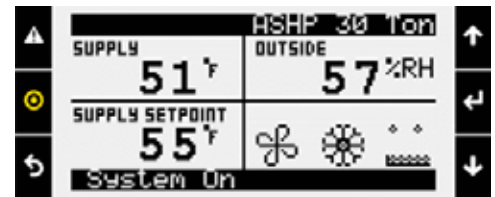

**Unit Display**



**Web User Interface**



Logged in with Service, red boxes will appear after logging in.

## Main Menu Navigation

Unit Enable	Main Status	Ctrl Variables	Alarm Menu																												
	<ul style="list-style-type: none"> <li>↳ Unit Status</li> <li>↳ Input Output Status</li> </ul> <p><b>Note:</b> Additional status screens are displayed depending on unit configuration. Screens may include, but are not limited to:</p> <ul style="list-style-type: none"> <li>Occupancy</li> <li>Damper positions</li> <li>Fan status</li> <li>Airflow</li> <li>Set Points</li> <li>Economizer</li> <li>Energy recovery</li> <li>Cooling</li> <li>Circuit pressure</li> <li>Heating</li> <li>Dehumidification</li> <li>Static pressure</li> </ul>	<ul style="list-style-type: none"> <li>↳ Temp Control</li> <li>↳ Dehumidification</li> </ul> <table border="1" style="width: 100%; border-collapse: collapse;"> <tr> <td style="width: 40%; vertical-align: top;">↳ Refrigeration</td> <td> <ul style="list-style-type: none"> <li>↳ Compressor Control</li> <li>↳ Pressure Control</li> <li>↳ Heat Pump Control</li> </ul> </td> </tr> </table> <ul style="list-style-type: none"> <li>↳ Damper Control</li> <li>↳ Energy Recovery</li> </ul> <table border="1" style="width: 100%; border-collapse: collapse;"> <tr> <td style="width: 40%; vertical-align: top;">↳ Fan Control</td> <td> <ul style="list-style-type: none"> <li>↳ Supply Fan Control</li> <li>↳ Exhaust Fan Control</li> </ul> </td> </tr> </table> <ul style="list-style-type: none"> <li>↳ Occupancy</li> </ul> <ul style="list-style-type: none"> <li>↳ Advanced</li> </ul> <p><b>Note:</b> The Advanced menu is read-only. The service password is required to change these settings. Reference the Advanced menu section for more information.</p> <p>*Consult factory for more information.</p> <table border="1" style="width: 100%; border-collapse: collapse;"> <tr> <td style="width: 40%; vertical-align: top;">↳ Login</td> <td></td> </tr> <tr> <td style="width: 40%; vertical-align: top;">↳ Manual Overrides</td> <td></td> </tr> <tr> <td style="width: 40%; vertical-align: top;">↳ Adv. Set Points*</td> <td></td> </tr> <tr> <td style="width: 40%; vertical-align: top;">↳ PID Tuning*</td> <td></td> </tr> <tr> <td style="width: 40%; vertical-align: top;">↳ Network Settings</td> <td></td> </tr> <tr> <td style="width: 40%; vertical-align: top;">↳ Backup/Restore</td> <td></td> </tr> <tr> <td style="width: 40%; vertical-align: top;">↳ IO Status/Offset*</td> <td></td> </tr> <tr> <td style="width: 40%; vertical-align: top;">↳ IO Config</td> <td></td> </tr> <tr> <td style="width: 40%; vertical-align: top;">↳ Unit Config*</td> <td> <ul style="list-style-type: none"> <li>↳ Service Config</li> <li>↳ Factory Config</li> </ul> </td> </tr> <tr> <td style="width: 40%; vertical-align: top;">↳ Unit Settings*</td> <td></td> </tr> <tr> <td style="width: 40%; vertical-align: top;">↳ Service Info*</td> <td></td> </tr> <tr> <td style="width: 40%; vertical-align: top;">↳ Alarm Management</td> <td> <ul style="list-style-type: none"> <li>↳ Shutdown Alarms</li> <li>↳ General Alarms</li> </ul> </td> </tr> </table>	↳ Refrigeration	<ul style="list-style-type: none"> <li>↳ Compressor Control</li> <li>↳ Pressure Control</li> <li>↳ Heat Pump Control</li> </ul>	↳ Fan Control	<ul style="list-style-type: none"> <li>↳ Supply Fan Control</li> <li>↳ Exhaust Fan Control</li> </ul>	↳ Login		↳ Manual Overrides		↳ Adv. Set Points*		↳ PID Tuning*		↳ Network Settings		↳ Backup/Restore		↳ IO Status/Offset*		↳ IO Config		↳ Unit Config*	<ul style="list-style-type: none"> <li>↳ Service Config</li> <li>↳ Factory Config</li> </ul>	↳ Unit Settings*		↳ Service Info*		↳ Alarm Management	<ul style="list-style-type: none"> <li>↳ Shutdown Alarms</li> <li>↳ General Alarms</li> </ul>	<ul style="list-style-type: none"> <li>↳ Alarm History</li> <li>↳ Active Alarms</li> <li>↳ Reset History</li> <li>↳ Clear History</li> <li>↳ Export History</li> </ul>
↳ Refrigeration	<ul style="list-style-type: none"> <li>↳ Compressor Control</li> <li>↳ Pressure Control</li> <li>↳ Heat Pump Control</li> </ul>																														
↳ Fan Control	<ul style="list-style-type: none"> <li>↳ Supply Fan Control</li> <li>↳ Exhaust Fan Control</li> </ul>																														
↳ Login																															
↳ Manual Overrides																															
↳ Adv. Set Points*																															
↳ PID Tuning*																															
↳ Network Settings																															
↳ Backup/Restore																															
↳ IO Status/Offset*																															
↳ IO Config																															
↳ Unit Config*	<ul style="list-style-type: none"> <li>↳ Service Config</li> <li>↳ Factory Config</li> </ul>																														
↳ Unit Settings*																															
↳ Service Info*																															
↳ Alarm Management	<ul style="list-style-type: none"> <li>↳ Shutdown Alarms</li> <li>↳ General Alarms</li> </ul>																														



## Unit Status Overview

The microprocessor controller will revert to a default main menu loop. This loop includes several screens to view the operating conditions of the unit. Scroll through the menu screens by using the   buttons.

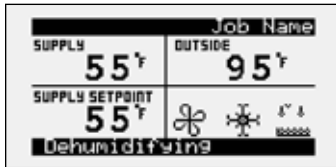







**THE INITIAL MENU SCREEN DISPLAYS THE JOB NAME, UNIT TAG, UNIT STATUS, OUTSIDE AIR CONDITIONS, SPACE CONDITIONS AND SET POINTS.**

Possible modes include:

- Off/Standby
- Unoccupied Start
- Dampers Open
- Fan Start Delay
- Fans Starting
- Startup Delay
- System On
- Soft Shutdown
- System Disabled
- Remote Off
- Shutdown Alarm
- Fans Only
- Economizing
- Cooling
- Dehumidifying
- Heating
- HGRH Purging
- Defrost Active
- Overrides Active
- Expansion Offline

### Unit Status Screen Symbols

Symbol	Indicates
	Supply air fan status. Rotation indicates airflow; static blades indicate no airflow.
	Cooling
	Heating
	Dehumidifying
	Economizing
	Defrost

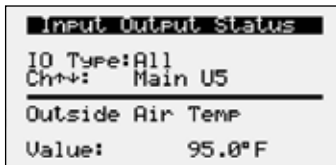

### INPUT OUTPUT STATUS

Displays real time conditions from sensors located in the unit and building space if equipped with space mounted sensors. Controller output conditions can also be viewed from this screen. To view the desired input/output point, the user must select the desired channel. Reference the Controller Overview section in this manual for individual point locations.

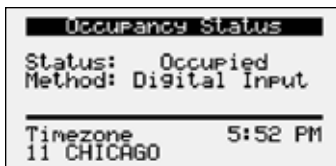

### OCCUPANCY STATUS

Displays current status of occupancy and the configured occupancy control method and time zone.



### DAMPER COMMANDED POS

This screen appears if equipped with modulating OA and recirculated air dampers. Displays current position of the OA damper.

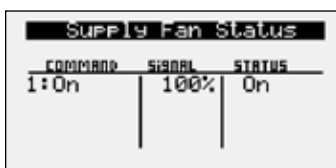

### SUPPLY FAN STATUS

This screen displays the fan enable command, fan proving status, and the supply fan ramp being sent from the controller to the VFD. The min and max speeds are set in the VFD (Reference unit Installation and Operation Manual for VFD programming). The controller can modulate the fan between the min and max speeds via an analog output.

## Unit Status Overview

Exhaust Fan Status		
COMMAND	SIGNAL	STATUS
1:On	100%	On

Airflow Status	
Exh Fan:	0
OAD:	0

Ambient Lockout Status	
Heating:	Disabled
Cooling:	Allowed
Outside Temp:	95.0f

Outside Reset	
Outside Temp:	95.0f
Supply Spt:	55.0f
Active Spt:	55.0f

Active Reset	
Supply Temp:	70.0f
Supply Spt:	72.0f
Cooling Spt:	74.0f
Heating Spt:	70.0f
Active Spt:	72.0f

Supply Setpoint	
Supply Temp:	71.5f
Setpoint:	72.0f

Economizer Ramp	
Setpoint:	72.0f
Temp:	71.5f
Ramp:	Disabled
Mode:	0%
Outside Dry Bulb	

CO <sub>2</sub> Ramp Output	
Setpoint:	1000ppm
CO <sub>2</sub> Level:	0ppm
Ramp:	Disabled 0%

Energy Recovery	
Status:	Enabled
Ramp:	100%
100% = Full Speed	

### EXHAUST FAN STATUS

This screen displays the fan enable command, fan proving status, and the exhaust fan ramp being sent from the controller to the VFD. The min and max speeds are set in the VFD (Reference unit Installation and Operation Manual for VFD programming). The controller can modulate the fan between the min and max speeds via an analog output.

### AIRFLOW STATUS

This screen displays the current status of airflow volumes if the unit is provided with airflow monitoring.

### AMBIENT LOCKOUT STATUS

Displays heating and cooling lockout status based on the outside air ambient temperature. Ambient lockouts for heating and cooling can be altered by entering Main Menu/Ctrl Variables/Temp Control/Cooling or Heating.

### OUTSIDE RESET

This screen will be active if the controller is configured for outside air reset. The heating and cooling devices modulate to maintain the supply air temperature set point as determined by the outside reset calculation.

### ACTIVE RESET

This screen will be active if temperature control mode is set for space or return air reset. The supply temperature set point is calculated based on the active set point and the current space or return temperature. The calculated set point is scaled between the supply temperature min and max set points determined by the current mode of operation.

### SUPPLY SET POINT

This screen is active when supply temp control is selected or the active mode of control. Displays current supply temperature and supply temperature set point to be achieved.

### ECONOMIZER RAMP

The economizer ramp screen will be active if the unit is configured for economizer control. This screen displays the economizer set point, supply air discharge temperature, economizer ramp status, and economizer control mode. Economizer control mode options include, outside dry bulb, outside enthalpy, comparative dry bulb, and comparative enthalpy.

### CO<sub>2</sub> RAMP OUTPUT

The CO<sub>2</sub> Ramp Output screen will be active if the unit is configured for CO<sub>2</sub> control. This screen displays the CO<sub>2</sub> set point, CO<sub>2</sub> level from the space, and the status of the control ramp.

### ENERGY RECOVERY WHEEL STATUS

This screen provides overall status of the energy recovery wheel.

## Unit Status Overview

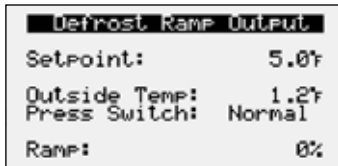

### DEFROST RAMP OUTPUT

This screen only appears if the unit has an energy recovery wheel and a frost control method was provided on the unit.

Upon sensing a high differential pressure across the energy wheel, the unit will go into defrost if the outside air temperature is below the defrost temperature set point.

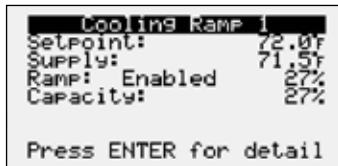

### COOLING RAMP 1

This screen displays the active set point, supply discharge temperature, cooling enable/disable, cooling ramp being sent from the controller, and the overall capacity being demanded.

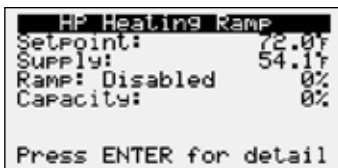

### HEAT PUMP HEATING RAMP

The Heat Pump Heating Ramp status screen is active when the unit is configured as a heat pump. The screen displays the active set point, supply temperature, status of the heat pump heating control ramp, the current ramp percentage, and the current capacity of the operating compressors.

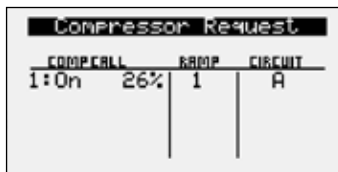

### COMPRESSOR REQUEST

The compressor request screen will be active if the unit is equipped with DX cooling. This screen displays overall status of individual compressor operation being sent from the unit controller. Example: Circuit A compressor enable (On) with modulating value of 26%.

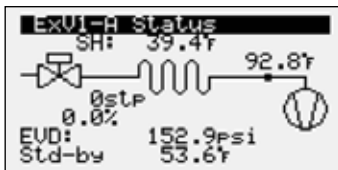

### EXV STATUS

The ExV Status screen is active when the unit is equipped with an inverter scroll compressor and electronic expansion valve (ExV). The screen displays information from the EVD (electronic valve driver) including the number of steps (stp) of the valve, the open percentage of the valve, the EVD control status, the suction superheat, the suction temperature, the suction pressure, and the saturated suction temperature. The second status screen also displays the capacity of the circuit the valve is installed on and the discharge refrigerant temperature for that circuit.

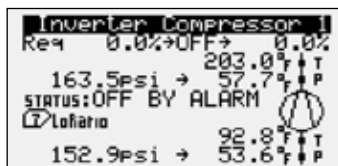

### INVERTER COMPRESSOR STATUS

The inverter compressor screen is active when an inverter scroll compressor is installed in the unit. This screen displays information about the operation of the inverter scroll starting with the requested capacity of the compressor compared to its actual operating capacity. The requested capacity and the actual could be different at startup and depending on where it is in the operating envelope. The status of the compressor, current envelope zone and current refrigerant temperatures and pressures are also displayed.

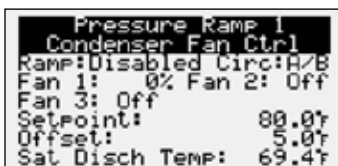

### CONDENSER FAN STATUS

The pressure control status screen is active when a unit is equipped with active head pressure control, this is currently available only with inverter scroll compressors. This screen provides information regarding the outside fan ramp status, circuits affected by the ramp, the status of the fans, and the set point, offset and current saturated temperature.

Circuit H			
	SATURATED	PRESSURE	LINE
S	54°F	152psi	93°F
D	58°F	163psi	203°F
L			
Superheat:			39°F

Heating Ramp	
SetPoint:	72.0°F
SUPPLY:	71.5°F
RAMP: Disabled	0%

Dehumidification	
Status:	Enabled
Based On:	
OAT > Coil Set+Offset	
Overcooled:	No
Enable Delay:	0s

HGRH Ramp Output	
SetPoint:	55.0°F
SUPPLY TEMP:	55.0°F
RAMP: Enabled	9%
Act. HGRH Circuits:	A,

SUPPLY SPACE STATIC	
Output:	0.0%
Static:	0.000"WC
SetPoint:	0.050"WC

SUPPLY DUCT STATIC	
Output:	0.0%
Static:	0.000"WC
SetPoint:	1.000"WC

Outside Air Conditions	
Temp:	51.8°F
Humidity:	61%
Enthalpy:	17.9btu/lb
Dewpoint:	38.6°F

Space Conditions	
Temp:	71.6°F
Humidity:	80%
Enthalpy:	31.9btu/lb
Dewpoint:	65.2°F

---

### REFRIGERANT CIRCUIT STATUS

---

The refrigerant circuit status screen is active when the unit is equipped with active head pressure control. This screen provides temperatures and pressures for suction, discharge, and liquid line sensors when installed. Superheat is also displayed when suction temperature and pressure sensors are installed.

---

### HEATING RAMP

---

This screen displays the active set point, supply air temperature, status of the heating control ramp, and heating ramp being sent from the controller.

---

### DEHUMIDIFICATION

---

This screen will display the overall dehumidification status and selected dehumidification control mode.

The following dehumidification modes are available when the space is in occupied mode:

- Cold coil set point plus offset (10°F)
- Inside RH\*
- Inside dew point\*
- Outside dew point
- Inside RH or inside dew point\*
- Inside RH or inside dew point or outside dew point
- Inside RH and inside dew point\*
- Inside RH and inside dew point or outside dew point

\*Available during unoccupied mode.

---

### HGRH RAMP

---

This screen will display the status of the hot gas reheat ramp. The screen includes the active set point, supply air discharge temperature, the ramp status, and hot gas reheat valve request being sent from the controller.

---

### SUPPLY SPACE STATIC

---

This screen displays status points if the unit is configured for space static pressure control. Status points include controller output ramp, static pressure in the space, and the space static pressure set point. Similar status screen will appear for the exhaust fan if the unit is configured for exhaust fan space static control.

---

### SUPPLY/RETURN DUCT STATIC

---

This screen displays status points if the unit is configured for duct static pressure control. Status points include controller output ramp, static pressure in the duct, and the duct static pressure set point. Similar status screen will appear for the exhaust fan if the unit is configured for exhaust fan duct static control.



---

### CONDITIONS

---

The condition screens are active when both temperature and humidity sensors for the location are installed in the unit. The enthalpy and dew point are calculated based on the temperature and humidity readings. The unit altitude is used for the enthalpy calculation.

## Menu

The controller is equipped with several menus to help guide users with altering program parameters. The following menus can be accessed by pressing the  button. To enter the desired menu, press the  button.

### Unit Enable

The **Unit Enable** menu allows the user to enable and disable the unit through the controller. Reference sequence of operation for additional unit starts/stop details.

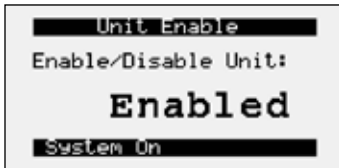

The unit ships from the factory in a disabled state. To allow the unit to operate, the controller must receive a run command from digital input ID4. **Jumper unit terminals R - G to allow the unit to operate.**

**Change to (Enabled/Disabled):** Enables user to manually turn unit on/off via display. Unit terminal **G** must have 24 VAC power to enable the unit.

### Control Variables

The **Control Variables** menu allows the user to view and adjust unit control parameters.

#### Control Variables

 Temp Control

The **Temperature Control** menu allows the user to view and adjust temperature control conditions of the unit.

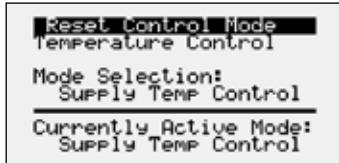

#### METHOD FOR TEMPERATURE CONTROL

##### Set Point Selections:

**Supply Temp Control** – The supply discharge set point is a constant value (e.g. 72°F). Reference Temperature Set point screen for set point adjustment.

**Space Reset** – The controller will reset the supply air temperature set point to maintain the space temperature set point (requires space temp sensor). Reference the Temperature Set point screen for space set point adjustment.

**Return Reset** – The controller will reset the supply air temperature set point to maintain the return air temperature set point (requires duct mounted return air temp sensor). Reference the Temperature Set point screen for return air set point adjustment.

**OA Reset** – The controller monitors the OA temperature and adjusts the desired supply temperature set point accordingly. For example, when the OA is below 55°F, the controller will change the supply set point to 70°F. If the OA is above 65°F, the controller will change the supply set point to 55°F. If the OA temperature is between 55°F and 65°F, the supply set point changes according to the OA reset function. A visual representation of the OA reset function is shown below. Reference Outside Set points for min and max outside air limits.

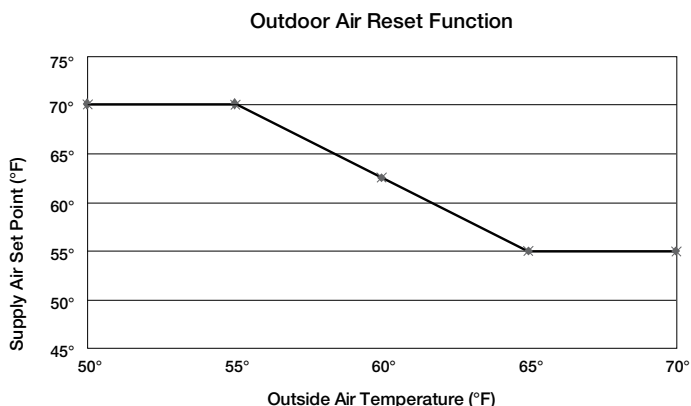

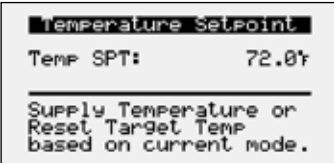

**TEMPERATURE SET POINT**

This screen only appears if supply temp control, space reset, or return reset is selected as the reset control mode.

**Set Point Selections:**

*Local* – The space set point will be constant; set from screen (e.g. 72°F).

*BMS* – The BMS can directly control the space temperature set point (requires BMS communication option).

*T-Stat* – The space set point will be adjustable from the space thermostat.

Reference Appendix: Room Thermostat Quick Start for additional information.

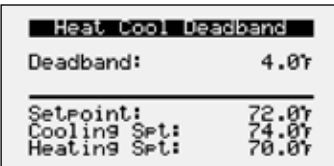

**HEAT COOL DEADBAND**

This screen only appears if space reset or return air reset is selected as the reset control mode. The heat cool deadband allows for separate cooling and heating set points when the reset control mode is set for space reset or return air reset.

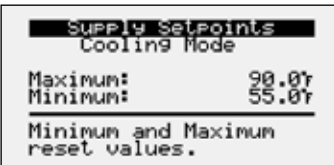

**SUPPLY SET POINTS**

Cooling and heating supply set points screens only appear if outdoor reset, space reset, or return air reset is selected. These screens allow the user to set the min and max set point limits for cooling or heating operation. The controller will adjust the supply temperature set point between the set limits depending on mode of operation.

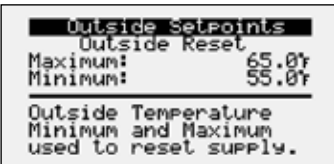
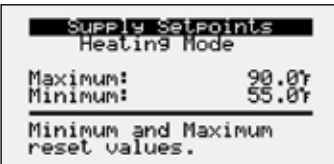

**OUTSIDE SET POINTS**

This screen only appears if outside reset is selected as the reset control mode.

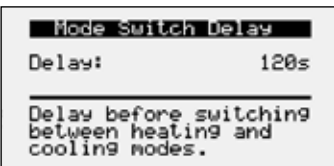

**MODE SWITCH DISPLAY**

This screen displays the delay time required before switching between heating and cooling mode.



**STARTUP DISPLAY**

This screen displays the delay time after the fans have started and tempering begins



**COOLING LOCKOUT**

This screen displays the cooling lockout temperature. Cooling will be disabled when outside air is below the cooling lockout temperature (55°F).

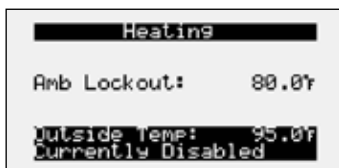

**HEATING LOCKOUT**

This screen displays the heating lockout temperature. Heating will be disabled when outside air is above the lockout temperature (80°F).

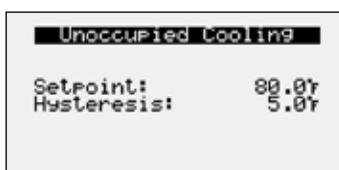

**SPACE SET POINTS DURING UNOCCUPIED MODE**

The controller will have separate screens for unoccupied cooling and heating set points.

Unoccupied Cooling Example: If set point = 80°F, unoccupied cooling is enabled when space equals 80°F and above. Unoccupied cooling is disabled when space temperature is below 75°F.

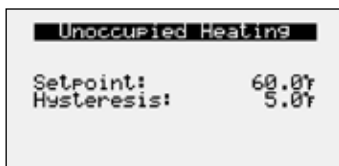

Unoccupied Heating Example: If set point = 60°F, unoccupied heating is enabled when space temperature equals 60°F and below. Unoccupied heating is disabled when space temperature is above 65°F.

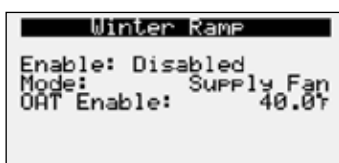

**WINTER RAMP**

The winter ramp function prevents the supply temperature from dropping below set point under the following conditions:

- Outside air temperature is below the winter ramp enable set point; and
- Heating capacity is at 100%

One of the following is used to perform the winter ramp function:

- Supply fan speed; or
- Outside air damper position

Note: If the unit is a heat pump, the supply fan is always used.

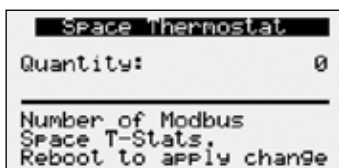

**MODBUS SPACE T-STAT**

The quantity of thermostats installed in the space that communicate the temperature, humidity, and set point to the controller. The controller averages the temperature and humidity readings when there is more than one installed. See Appendix C for more information.

**Control Variables**

↳ Dehumidification

```
Dehumidification Mode
Dehumidify when:
OAT > Coil Spt + 10.0°F
Space RH Spt: 55%RH
```

The **Dehumidification** menu allows the user to view and adjust dehumidification control parameters.

**DEHUMIDIFICATION MODE - OCCUPIED.**

**Possible Modes:**

- Outside Air Temp is greater than cold coil set point plus offset (10°F)
- Inside RH\*
- Inside dew point\*
- Outside dew point
- Inside RH or inside dew point\*
- Inside RH or inside dew point or outside dew point
- Inside RH and inside dew point\*
- Inside RH and inside dew point or outside dew point

\*Available during unoccupied mode.

There must be a constant call for dehumidification for the duration of the enable delay for dehumidification mode to become enabled. The call remains active until conditions are satisfied and dehumidification mode has been active for the min active time. Reference Ctrl Variables/Advanced/Unit Config/Unit Configuration Occupied Dehum Call for dehumidification method options.

```
Dehumidification Mode
Unoccupied Mode
Dehumidify when:
Indoor RH > 60%RH
```

**DEHUMIDIFICATION MODE - UNOCCUPIED.**

If the unit is unoccupied while there is a dehumidification call, the unit will start and dehumidify until the unoccupied dehumidification set points are satisfied. The above dehumidification modes marked with an \* indicate availability during unoccupied mode. The unoccupied dehumidification mode can be set differently than the occupied dehumidification mode. Reference Ctrl Variables/Advanced/Unit Config/Unit Configuration Unoccupied Dehum Call for dehumidification method options.

**DEHUMIDIFICATION HYSTERESIS**

This screen displays hysteresis for enabling dehumidification during occupied and unoccupied conditions. %RH for indoor RH control and °F for indoor dew point control. Example: If indoor RH set point = 50%, dehumidification is enabled when indoor RH equals 50% and above. Dehumidification is disabled when indoor RH is below 44%.

```
Dehumidification Mode
On Delay: 2m
Minimum On time: 15m
```

**DEHUMIDIFICATION TIMERS**

This screen allows adjustment for delay and min on time for dehumidification mode. Times are in place to prevent short cycling between dehumidification and other control modes.

```
Cold Coil SetPoint
Coil Spt Min: 55.0°F
Coil Spt Max: 55.0°F
Cooling Coil leaving
temp set. Value reset
based on demand.
```

**COLD COIL SET POINT**

This screen displays the temperature set points for the cooling coil. This screen only appears if the unit is equipped with cooling. When in dehumidification mode, the cooling ramp maintains the cold coil set point by increasing or decreasing the amount of cooling provided from the cooling device installed. The calculated coil set point has a min and max set point that is based on the demand from the dehumidification ramp. When the demand is high, the temperature is low. If a constant temperature off the coil is desired during dehumidification, the min and max can be set to the same value. If a BMS is available, the set points can be adjusted over the BMS.



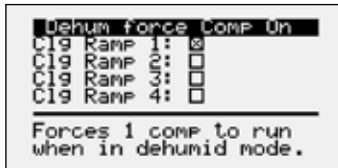
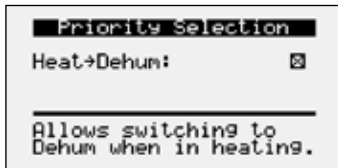
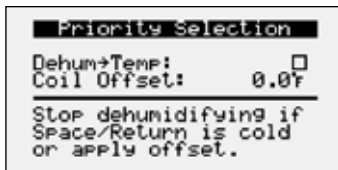

---

## DEHUMIDIFICATION PRIORITY

---

The following priorities are used to determine what is more important in the unit: temperature over dehumidification or heating over dehumidification. Both priority selections determine when the unit is allowed to dehumidify.

### 1. Temperature over Dehumidification

Determines when the unit is allowed to dehumidify based on the space/return air temperatures.

**a. Temperature** - If temperature is set as the priority, box not checked, and the space or return air is over cooled, dehumidification is locked out until the space or return temperature is no longer overcooled.

**b. Dehumidification** - If the priority is dehumidification, box checked, and the space or return air is overcooled, the coil offset will be added to the coil leaving set point. (Default 0°F offset).

**c. Overcooled** - If space or return reset is enabled, the target is considered over cooled when it is 4°F below set point for 5 minutes. It remains overcooled until the target is at set point and the over-cool logic has been active for a min of 5 minutes.

### 2. Heating over Dehumidification

Determines when the unit is allowed to dehumidify when heating is active.

**a. Heating** - If priority is set to heating, box in checked, the unit locks out dehumidification while heating is active.

**b. Dehumidification** - If priority is set to dehumidification, box is not checked, the unit is allowed to switch to dehumidification when heating is active.

---

## COMPRESSOR DEHUMIDIFICATION FORCE.

---

In dehumidification mode, the lead compressor will continue to run as long as the dehumidification mode sequence has been enabled in order to prevent compressor cycling and potential reevaporation of moisture. To disable this operation and allow the compressor to cycle in dehumidification mode, uncheck the applicable cooling ramps.

## Menu

### Control Variables

↳ Refrigeration

The **Refrigeration** menu allows the user to view and adjust compressor and condenser settings, if equipped.

### Control Variables

↳ Refrigeration  
↳ Compressor Control

#### **COMPRESSOR CONTROL**

Consult factory prior to adjusting parameters in the compressor control menu.

### Control Variables

↳ Refrigeration  
↳ Pressure Control

#### **PRESSURE CONTROL**

Consult factory prior to adjusting parameters in the pressure control menu.

### Control Variables

↳ Refrigeration  
↳ Heat Pump Control

#### **COMPRESSOR CONTROL**

Allows the user to adjust heat pump heating control set points.



#### **AIR-SOURCE HEAT PUMP AMBIENT LOCKOUT**

The screen allows the user to adjust the minimum ambient temperature the compressors can be utilized for heating. When the outside air temperature drops below this temperature, heating with the compressors will not be allowed.

### Control Variables

↳ Damper Control

#### **HEAT PUMP DEFROST**

Consult factory prior to adjusting set points related to heat pump defrost operation.

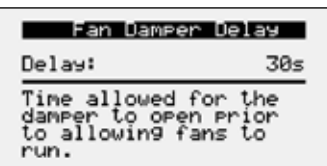

#### **FAN DAMPER DELAY**

This screen allows adjustment for delay time between damper opening and fan operation. This timer allows the damper to open before the fan start sequence begins. This prevents the fans from having to overcome higher static pressure when the damper(s) are opening.



#### **OUTSIDE DAMPER POSITION**

This screen only appears if equipped with a modulating OA and recirculating damper. The screen displays the min and max positions for the outside air damper. These set points reflect the percentage of the outside air damper being opened.

0% = Full recirculation air  
100% = Full OA



**Minimum Position** – When in the occupied mode, the active set point will be equal to a local min OA set point, which may be constant or reset by fan speed if equipped with a modulating supply fan.

The OA damper set point can then be further adjusted between the min and max OA settings with sequences such as DCV CO<sub>2</sub>, Building Pressure and Economizer.

## Menu

```
OAD SF Reset
OAD Supply Fan Reset
Installed: 
-----
Allows damper to be
limited based on
supply fan speed.
```

```
Outside Damper
Supply Fan Reset
SF Speed 50%--> 100%
-----
Minimum: 35%--> 20%
CO2 Maximum: 50%
Maximum: 100%--> 100%
```

```
CO2 Setpoint
-----
Setpoint: 1000PPM
-----
CO2 Level: 0PPM
```

```
Economizer Mode
-----
Selected Mode:
Outside Dry Bulb
-----
Active Mode:
Outside Dry Bulb
```

```
Economizer Settings
Outside Dry Bulb
-----
Setpoint: 65.0F
-----
Sensor Status: Valid
Mode Status: Not Ready
Econ Status: Disabled
```

```
Economizer Settings
Outside Enthalpy
-----
Setpoint: 23.0btu/lb
-----
Sensor Status: Invalid
Mode Status: Not Ready
Econ Status: Disabled
```

```
Economizer Settings
Comparative Dry Bulb
-----
Sensor Status: Invalid
Mode Status: Not Ready
Econ Status: Disabled
```

```
Economizer Settings
Comparative Enthalpy
-----
Sensor Status: Invalid
Mode Status: Not Ready
Econ Status: Disabled
```

**Maximum Position** – Each sequence that can adjust the OA damper set point contains a max position to prevent excess OA. The active set point will be determined based on the greatest demand of the configured sequences. For example, if a unit is equipped with a DCV CO<sub>2</sub> and an economizer sequence, the OA damper set point will react to an economizer demand even if the CO<sub>2</sub> set point is satisfied. Likewise, if economizer is not available but CO<sub>2</sub> is above set point, the OA damper will open to satisfy the CO<sub>2</sub> set point.

**Economizer** – The active set point will be reset based on Economizer demand, between the min and max positions.

### **Set Point Selections:**

**Local** – The min OA percentage is constant; set by the controller.

**SF Reset** – The min and max positions are reset by the supply fan speed.

**BMS** – The BMS can directly control the OA damper position between the min and max percentages.

**Building Pressure** – Damper position is reset by a building pressure control loop.

**DCV CO<sub>2</sub>** – Damper position is reset by a demand-controlled ventilation control loop based on space CO<sub>2</sub> levels. The CO<sub>2</sub> max is the highest percentage that the OA damper can modulate when solely based on CO<sub>2</sub>.

**2 Position** – Damper position is reset to “2-Pos/Max Vent:” set point when a contact closure is made. The 2-position damper operation can be configured to temporarily force the unit into occupied mode until the contact is open (Max Ventilation Mode - enabled in Advanced menu).

---

### **ECONOMIZER CONTROL VARIABLES.**

---

The economizer screen appears when economizer function is enabled.

The outside air damper will modulate between the min and max position to maintain the supply temperature set point.

The user can select the economizer control method from the following options:

**Outside Dry Bulb** – Economizing is allowed when the outside dry bulb is less than the economizer temperature enable set point.

**Outside Enthalpy** - Economizing is allowed when outside enthalpy is less than the economizer enthalpy set point.

**Comparative Dry Bulb** - Economizing is allowed when outside temperature is less than the space or return temperature.

**Comparative Enthalpy** - Economizing is allowed when outside enthalpy is less than the space or return enthalpy.

## Menu

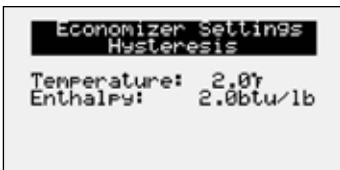

### ***ECONOMIZER SETTINGS***

There is a built-in hysteresis that disables economizer above the economizer set point.

(Example: If economizer outside dry bulb = 65°F, economizer operation is disabled above 67°F).

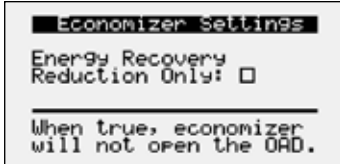

### ***ENERGY REDUCTION ONLY CONTROL.***

If enabled, the OA damper and recirculation damper will not modulate during economizer. Instead, only the energy recovery wheel will be stopped to ensure no energy is transferred from the supply airstream and exhaust airstream.

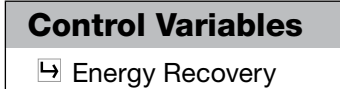

The **Energy Recovery** menu allows the user to adjust energy recovery wheel sequence set points.



### ***DEFROST RAMP***

This screen displays the temperature at which the unit will enable frost control mode if necessary (factory default = 5°F) This screen only appears if the unit has an energy recovery wheel and a frost control method was provided with the unit.

Upon sensing a high differential pressure across the energy wheel, the unit will enter defrost mode if the outside air temperature is below this temperature setting. Max active time and min off time will be available if the frost control method was provided as timed exhaust or cycle wheel.

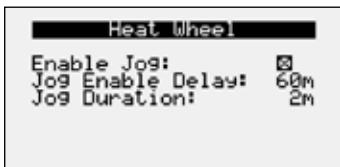

### ***ENERGY RECOVERY WHEEL JOG FUNCTION***

This screen display the energy recovery wheel jog function. This screen only appears if the unit has an energy recovery wheel and stop wheel economizer method for control.

Momentarily enables the wheel in order to expose a new section to the airstream.

## Control Variables

- ↳ Fan Control
- ↳ Supply Fan Control

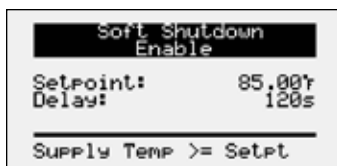
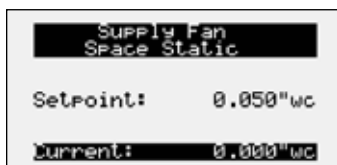
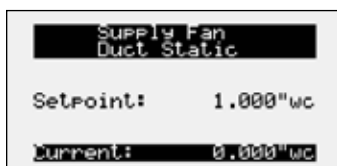
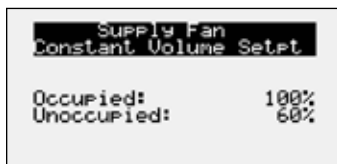
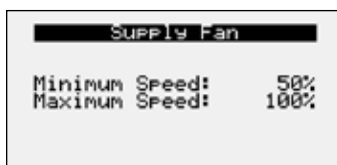
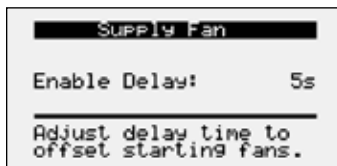

The **Supply Fan Control** menu allows the user to adjust exhaust control set points

### **SUPPLY FAN DELAY**

The supply fan delay will begin once the damper sequence is complete. This delay can be used to offset starting times between the supply fan and exhaust fan.

### **SUPPLY FAN SPEED**

This screen displays min and max supply fan speed percentages. The speed set point is the proportional percentage of the analog output from the controller to the VFD.

50% Speed = Min speed

100% Speed = Max speed

#### **Set Point Selections:**

**Constant Volume** – The fan speed will be constant; set from screen (e.g. 100%).

**BMS** – The BMS can directly control the fan speed (requires BMS communication option).

**Duct Pressure** – Fan speed is determined by duct pressure control loop.

**Space Pressure** – Fan speed is determined by building pressure control loop.

**CO<sub>2</sub>** – Fan speed is determined by CO<sub>2</sub> control loop.

**Single Zone VAV** - The supply fan is modulated in addition to the supply air temperature to satisfy the space temperature set point.

**2-Speed (High Speed Set Point)** - Supply fan speed is reset to max speed when a contact closure is made. (Max Ventilation Mode).

### **SOFT SHUTDOWN ENABLE CONDITIONS**

During a soft shutdown the following will occur:

- Tempering outputs immediately revert back to their off value; while
- Dampers remain open and fans continue to run; until
  - The supply air temperature falls below the soft shutdown enable set point minus 5°F; or
  - The soft shutdown delay timer has expired.

**Control Variables**

- ↳ Fan Control
- ↳ Exhaust Fan Control

The **Exhaust Fan Control** menu allows the user to adjust exhaust control set points.

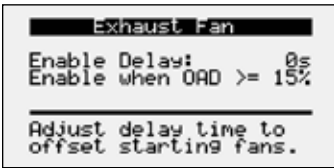

**EXHAUST FAN DELAY AND ENABLE**

This screen displays min and max exhaust fan speed percentages. This screen displays the exhaust fan delay and enable based on OA damper position. The exhaust fan delay will begin once the damper sequence is complete. This delay can be used to offset starting times between the supply fan and exhaust fan. This screen also provides the ability to enable the exhaust fan on a set OA damper position if the unit is equipped with a modulating OA damper.

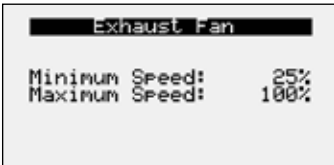

**EXHAUST FAN SPEED PERCENTAGES**

The speed set point is the proportional percentage of the analog output from the controller to the VFD.

- 25% Speed = Min speed
- 100% Speed = Max speed

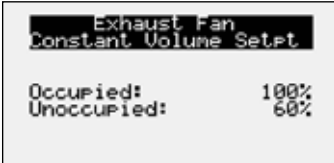

**Set Point Selections:**

- Constant Volume** – The fan speed will be constant; set from screen (e.g. 100%).
- BMS** – The BMS can directly control the fan speed (requires BMS communication option).

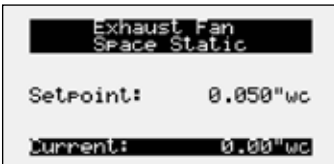

**Space Pressure** – Fan speed is determined by building pressure control loop.

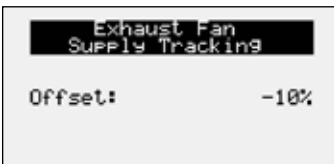

**Supply Fan Tracking with Offset** – The exhaust fan will track the supply fan, between a min and max position. An offset can be added to achieve the proper balance.

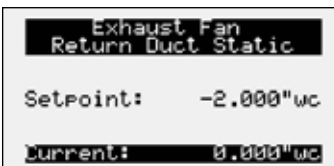

**Outside Air Damper Tracking** – The exhaust fan will proportionally track the OA damper, between a min and max position.

**Return Duct Static Pressure** – Fan speed is determined by duct pressure control loop.

### Control Variables

↳ Occupancy

```

Occupancy Control
Mode: Digital Input
BMS: Occupied
Digital In: Occupied
Schedule: Occupied
Timed Ovr: Unoccupied
    
```

```

Occupancy Schedule
Day: Friday
Schedule
Start Time: 06:00 AM
Stop Time: 06:00 PM
Currently: Occupied
    
```

```

Unoccupied Start
Enable Modes
Cooling: [X]
Heating: [X]
Dehumidification: [X]
    
```

```

Occ Timed Override
Enable: [ ]
Duration: 60m
Status: Unoccupied
Time Remaining: 0m
    
```

The **Occupancy** menu allows the user to adjust occupancy control parameters which includes occupancy control mode and schedule.

---

#### **OCCUPANCY CONTROL**

---

This screen displays the current mode of operation for occupancy control. Status of the other mode option can also be found on this screen. This screen allows the user to select the source of determining occupancy. The factory default is BMS control.

**BMS:** BMS control (Reference Points List). BMS can be overridden with ID6.

**Digital Input:** Typically used with a remote time clock, motion sensor or switch.

**Always Occ:** Controller will always remain in occupancy mode.

**Always Unocc:** Controller will always remain in unoccupancy mode.

**Schedule:** Allows the user to set an occupancy schedule for each individual day of the week.

---

#### **OCCUPANCY SCHEDULE**

---

This screen allows the user to adjust the schedule. Requires the user to enter a start time, stop time and the applicable days of the schedule.

---

#### **UNOCCUPIED START ENABLE MODES.**

---

*This screen only appears if unit is provided with unoccupied recirculation.*

This screen allows the user to enable/disable modes of operation when in unoccupied recirculation control.

---

#### **OCCUPANCY TIMED OVERRIDE**

---

Screen allows the user to override occupancy for a set duration.

## Menu

### Control Variables

↳ Advanced

#### User Login

Enter Password: 9998

Current Access:  
Service Level

The **Advanced** menu allows the user to access several submenus regarding controller information, controller overrides, network settings, I/O configuration, and unit configuration. Submenu options are read only and will require the user to input proper login criteria. The **service password (9998)** is required to change service access menus. Consult factory for factory level access.

### Control Variables

↳ Advanced

↳ Manual Overrides

The Manual Overrides menus are for start-up, commissioning, and troubleshooting.

#### IG Furnace Setup

Press ENTER to access  
IG Furnace Commission

Unit must be running

### IG FURNACE COMMISSIONING MENU

This screen only appears if an indirect gas furnace was provided with the unit. Entering the furnace commissioning menu will step the user through the furnace start-up.

#### Manual Override Mode

Enable:   
Duration: 720m

Time Remaining: 0:00  
Status: Disabled

### MANUAL OVERRIDE MODE

The Manual Overrides menu is for start-up, commissioning, and troubleshooting. This menu allows the user to override the control loops and specific inputs and outputs.

To access the Manual Overrides submenus, enter the **service password (9998)**. Manual overrides must be enabled at this screen to allow the user to override control loops. Override options must be changed from Auto to Manual for manual control.

#### Unit On Off

Override: Auto  
Value: On

enable Main Override

### OVERRIDE THE UNIT ON OR OFF

When manual override is set to enable, use the arrow buttons to turn the unit on or off.

#### Occupancy

Override: Auto  
Value: Occupied

enable Main Override

### OVERRIDE OCCUPANCY CONTROL

When manual override is set to enable, use the arrow buttons to change occupancy control.

#### Supply Fan

Override: Auto  
Command: On  
Speed: 100%

enable Main Override

### OVERRIDE THE SUPPLY FAN VFD SPEED

The speed is the proportional percentage of the analog output from the controller to the VFD.

0% Speed = Min speed (determined by VFD)

100% Speed = Max speed (determined by VFD)

(Reference unit Installation and Operation Manual for VFD programming).



```

Exhaust Fan
Override: Auto
Command:  On
Speed:    100%
enable Main Override
    
```

**VERRIDE EXHAUST FAN VFD SPEED**

This screen only appears if the unit is equipped with a exhaust fan VFD controlled by the microprocessor.

The speed is the proportional percentage of the analog output from the controller to the VFD.

0% Speed = Min speed (determined by VFD)

100% Speed = Max speed (determined by VFD)

(Reference unit Installation and Operation Manual for VFD programming).

```

Outside Damper
Override: Auto
Position:  35%
enable Main Override
    
```

**VERRIDE THE POSITION OF THE OUTSIDE AIR DAMPER**

This screen only appears if the unit is equipped with a modulating OA and recirculation damper. The recirculation damper position will be the inverse of the OA damper position shown.

0% = Outside air damper closed

100% = Outside air damper fully open

```

Compressor Request
Override: Auto
1: Off   2: Off
enable Main Override
    
```

**VERRIDE THE COMPRESSOR**

This screen only appears if the unit is equipped with DX cooling. When manual override is set to enable, use the arrow buttons to turn individual compressor requests on or off.

```

Compressor Signal
Override: Auto
1: 0%
enable Main Override
    
```

**VERRIDE THE MODULATING COMPRESSOR CONTROL LOOP**

When manual override is set to enable, use the arrow buttons to change the compressor modulation value.

```

Cooling Ramp 1
Override: Auto
Demand:  0%
enable Main Override
    
```

**VERRIDE COOLING**

When the cooling control is in the manual mode, use the arrow buttons to vary the cooling output.

**Chilled Water:** The cooling percent is directly proportional to the 0 - 10 VDC output signal.

0% Cooling = 0 VDC

100% Cooling = 10 VDC

**Packaged Cooling:** The cooling percent displays compressor engagement as a percent. The compressors are subject to the min on/off times and heating/cooling lockouts.

```

Electric Heat
Override: Auto
Elec Heater 1: 100%
enable Main Override
    
```

**VERRIDE THE ELECTRIC HEATER**

This screen only appears if the unit is equipped with electric post heat. Electric heater percentage is directly proportional to the 0 - 10 VDC output signal.

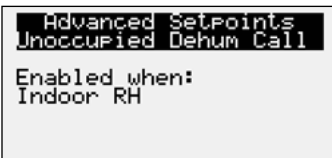
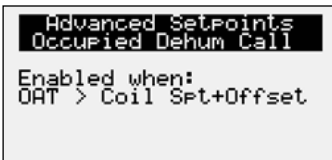
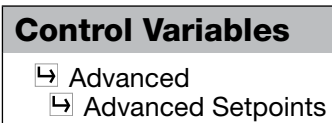
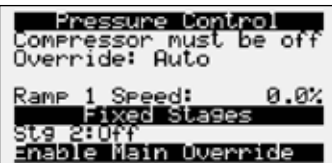
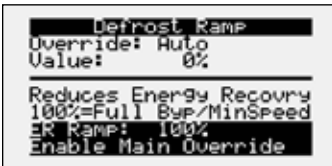
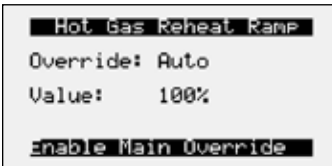
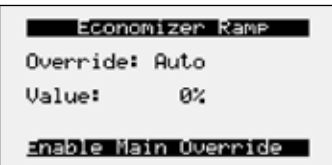
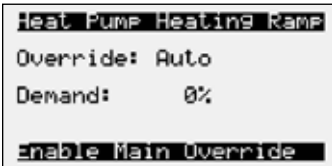
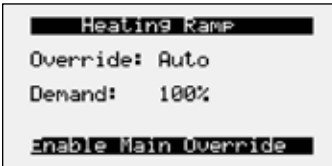

***VERRIDE HEATING***

When the heating control is in the manual mode, use the arrow buttons to vary the heating output.

***VERRIDE HEAT PUMP HEATING***

This screen will be available when the unit is configured as a heat pump. When in manual mode, change the demand to control the position of the reversing valve and the amount of compressor request. The compressors are subject to the min on/off times and heating lockouts.

***VERRIDE THE ECONOMIZER CONTROL***

When the heating control is in the manual mode, use the arrow buttons to vary the heating output.

***VERRIDE THE HOT GAS REHEAT***

This screen only appears if modulating hot gas reheat option was provided with the unit. When the hot gas reheat loop control is in the manual mode, use the arrow buttons to vary the reheat output.

***VERRIDE THE ENERGY RECOVERY DEFROST***

This screen only appears if modulating wheel frost control is equipped. When the defrost control ramp is in manual mode, use the arrow buttons to vary the defrost output.

- 0% = Maximum Wheel Speed
- 100% = Minimum Wheel Speed

***VERRIDE PRESSURE CONTROL FANS***

This screen will be available when active head pressure control is installed in the unit. When in manual mode, with the compressors off, the modulating fan speed can be altered by using the arrows to change the output. The fixed stage fan can be enabled by changing the output to On.

The Advanced Setpoints Menus allows the user to view and modify network settings. The **service password (9998)** is required to make changes.

***CCUPIED DEHUMIDIFICATION CALL.***

Reference control variables for possible Occupied dehumidification call methods.

***UNOCCUPIED DEHUMIDIFICATION CALL.***

Reference control variables for possible unoccupied dehumidification call methods.

## Menu

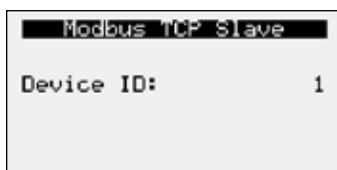
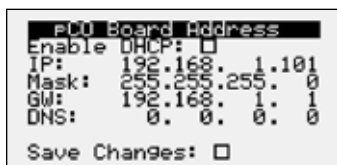
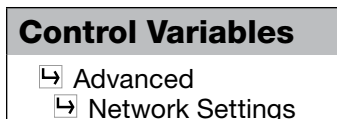
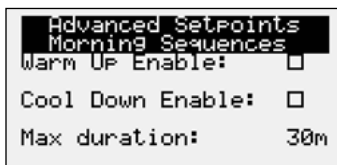
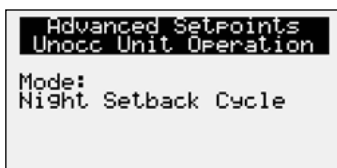

### **VIEW AND CHANGE THE UNOCCUPIED UNIT OPERATION.**

Possible unoccupied unit operation methods include:

- Unit Off
- Night Setback Cycle
- Recirculation with Unoccupied Set Points
- Normal Operation with Unoccupied Set Points

### **ENABLE MORNING WARM UP AND COOL DOWN.**

The user can enable morning warm up, morning cool down, and set the duration for the sequence.

The Network Settings Menu allows the user to view and modify network settings. The **service password (9998)** is required to make changes.

### **C.PCO BOARD ADDRESS**

This screen will appear with or without a network protocol provided with the unit.

This screen allows the user to configure the IP setting for BMS and/or when the Web User Interface will be utilized. The controller may have a DHCP server-assigned address or a manually-assigned static IP address. Factory settings are shown in the screen to the left.

### **CONTROLLER BACNET IP CONFIG**

This screen will appear if the unit is set for BACnet IP and allows the user to set the device and port settings.

**MODBUS TCP SLAVE.** This screen will appear if the unit is set for Modbus TCP and allows the user to set device ID number.

### **BACNET MSTP PARAMETERS**

This screen only appears if the selected BMS protocol is set to BACnet MSTP. Factory settings are shown in the screen to the left.

#### **To change BACnet MSTP parameters:**

1. Go to Network Settings menu and view BACnet MSTP Config screen.
2. Move cursor to desired parameter by pressing the enter button. Press up and down arrows to adjust the parameter. Press enter to accept adjusted value.
3. Once desired parameters have been entered, enable the 'Save Settings' option and press the enter button.
4. Reboot the controller by cycling power to the unit. Allow several minutes for the controller to initialize.

## Menu

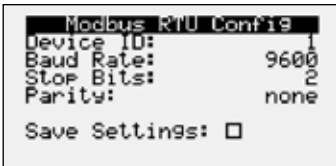

### **MODBUS RTU PARAMETERS**

This screen only appears if the selected BMS protocol is set to Modbus. Factory settings are shown in the screen to the left.

#### **To change Modbus RTU parameters:**

1. Go to Network Settings menu and view Modbus RTU Config screen.
2. Move cursor to desired parameter by pressing the enter button. Press up and down arrows to adjust the parameter. Press enter to accept adjusted value.
3. Once desired parameters have been entered, enable the 'Save Settings' option and press the enter button.
4. Reboot the controller by cycling power to the unit. Allow several minutes for the controller to initialize.

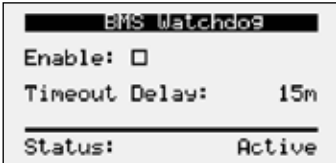

### **BMS WATCHDOG**

The BMS watchdog function verifies BMS connectivity. The watchdog is required for the BMS to take the place of a hardwired sensor. The BMS toggles the watchdog variable from true to false within the timeout delay. If the timer expires, the controller falls back to hardwired sensors until the BMS connection can be established. At this time, a BMS watchdog alarm activates.

The following variables may be used by the BMS in place of hardwired sensors:

- Outside\_RH\_from\_BMS
- Outside\_Temp\_from\_BMS
- Return\_RH\_from\_BMS
- Return\_Temp\_from\_BMS
- Space\_1\_CO2\_from\_BMS
- Return\_CO2\_from\_BMS
- Space\_RH\_from\_BMS
- Space\_Static\_from\_BMS
- Space\_Temp\_from\_BMS



### **SENSOR SOURCE**

The sensor source can be changed to source by BMS through the controller or by a dedicated BMS point. Reference Points List above and in the Appendix for more detailed point information. Screen to the left is an example of the sensor source type. Source can be set for local or BMS at this screen.

## Control Variables

- ↳ Advanced
- ↳ Backup/Restore

The Backup/Restore Menus allows the user to create a backup file of set points and configuration variables on a USB drive or in the controller's internal memory.

### **Connecting to USB Drives**

The controller has built-in USB ports for connecting to USB drives. The USB drives can be used for backing up all settings and reported conditions such as alarm history and current values. This creates a file named User\_Backup.txt.

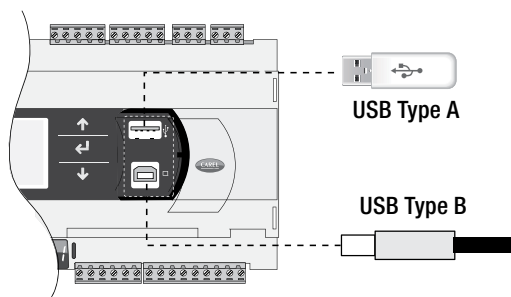

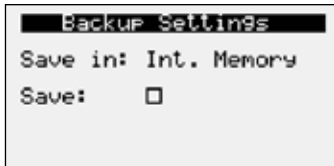

### ***CREATING A BACKUP FILE***

Important:

- At first startup or commissioning, or prior to communicating with Technical Support about performance issues, we recommend creating a backup file for each controller.
- Name each file with the unit sales order–line number found on the silver nameplate attached to the electrical access door.
- Also consider creating a backup file whenever significant program changes are made.

To create a system backup file using the handheld or virtual keypad/display buttons:

1. Go to the Main Menu/Ctrl Variables/Advanced/Login screen. Press the Enter and Up or Down arrow buttons to enter the service password, which is 9998.
2. Go to the Main Menu/Ctrl Variables/Advanced/Backup/Restore screen.
3. Press the Up or Down arrow buttons to navigate to the Backup Settings screen.
4. Press the Enter and Up or Down arrow buttons to select the backup location (internal memory or USB). If creating a backup to a USB drive, insert a USB drive into the main controller.
5. Press Enter to highlight and then the Up or Down arrow buttons to fill the Save checkbox. This action creates the backup file.

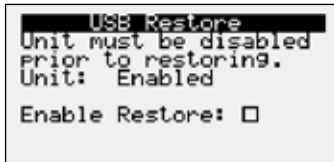

### ***RESTORING FROM A BACKUP FILE***

#### ***From USB***

1. Place the restore file in the root directory of a USB drive. (Do not place the file within a folder on the USB drive.) The file must be named: User\_Backup.txt
2. Insert the USB drive into the controller's USB port.
3. Go to the Main Menu/Unit Enable screen. Press the Enter and Up or Down arrow buttons to disable the unit.
4. Go to the Main Menu/Ctrl Variables/Advanced/Login screen. Press the Enter and Up or Down arrow buttons to enter the service password (9998).
5. Go to the Main Menu/Ctrl Variables/Advanced/Backup/Restore screen.
6. Press the Up or Down arrow buttons to navigate to the USB Restore screen.
7. Press Enter to highlight and then the Up or Down arrow buttons to fill the Restore checkbox. This action restores the backup file. If there is an error during the process, the specific error is displayed on this screen.
8. Cycle power to the controller.

#### ***From internal memory***

1. Go to the Main Menu/Unit Enable screen. Press the Enter and Up or Down arrow buttons to disable the unit.
2. Go to the Main Menu/Ctrl Variables/Advanced/Login screen. Press the Enter and Up or Down arrow buttons to enter the service password, which is 9998.
3. Go to the Main Menu/Ctrl Variables/Advanced/Backup/Restore screen.
4. Press the Up or Down arrow buttons to navigate to the Internal Restore screen. This screen is only available when a backup file exists in internal memory.
5. Press Enter to highlight and then the Up or Down arrow buttons to fill the Restore checkbox. This action restores the backup file. If there is an error during the process, the specific error is displayed on this screen.
6. Cycle power to the controller.

## Menu

### Control Variables

- ↳ Advanced
- ↳ I/O Configuration

```
I/O Configuration
IO Type: Analog Input
Supply Air Temp
Ch: M U4   Type: NTC

Value:      71.6°F
```

```
IO Conf Options
Editable: 
Scroll by
All Configured: 
```

### Control Variables

- ↳ Advanced
- ↳ Unit Config
- ↳ Service Config

```
Service Unit Config
Supply Fan Control

Type: Constant Volume
K Factor:      0.0
```

```
Service Unit Config
Exhaust Fan Control

Type: Space Static
K Factor:      0.0
```

The **IO Configuration Menu** allows the user to view and modify controller input and output points.

### ***I/O CONFIGURATION***

This screen is read only and will require the factory password to make changes. Screen to the left is an example of an analog input configuration screen. Similar screens appear for remaining I/O when selected.

#### ***To monitor individual I/O points:***

1. Press the enter button to highlight the I/O type.
2. Press the up and down arrows to change the IO type.
3. Press the enter button to highlight the controller channel.
4. Press the up and down arrows to change the channel.

### ***I/O CONFIGURATION OPTIONS***

Changes to the IO configuration requires the factory login password. Consult factory for IO configuration changes.

**ADJUSTMENT OF I/O CONFIGURATION MUST ONLY BE DONE UNDER FACTORY GUIDANCE! IMPROPER ADJUSTMENT MAY RESULT IN SYSTEM DAMAGE!**

The **Unit Configuration** menus allows the user to view unit configuration provided from factory. Configuration menus listed below can be altered with the service password. Consult factory for unit configuration changes!

### ***SUPPLY FAN CONTROL TYPE***

Reference control variables for possible supply fan control methods.

### ***EXHAUST FAN CONTROL TYPE***

Reference control variables for possible exhaust fan control methods.

### Alarms

The **Alarms** menu allows the user to view active alarms, reset active alarm (if possible), and alarm history.

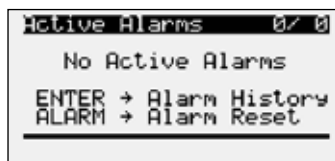

#### **ACTIVE ALARMS**

If an alarm occurs, the button will glow red on the controller and the remote display (if installed).

To view alarm, press the Alarm button once. This will display the most recent alarm. If the alarm cannot be cleared, the cause of the alarm has not been fixed. Press the up and down buttons to view any additional occurring alarms.



#### **RESET ACTIVE ALARMS**

This screen allows the user to clear active alarms.

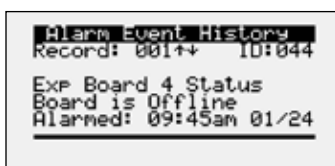

#### **ALARM EVENT HISTORY**

This screen allows the user view recent alarms. To view all saved alarms, press the “down” button to enter the data logger.

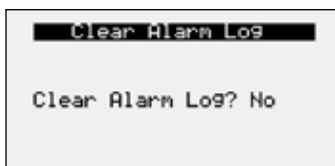

#### **CLEAR ALARM LOG**

This screen allows the user to clear all alarms in alarm log history.

### IG Furnace Alarm (AL) Descriptions

IG no flame 3 try AL	Indicates a furnace failure to light or properly sense flame after 3 trials.	Alarm only
IG combustion fan high pressure switch failure	Indicates a call for high speed combustion fan but high pressure switch did not close.	Alarm only
IG furnace ignition control	Indicates an alarm from the ignition controller.	Alarm only
Pressure switch closed with combustion fan off	Indicates low pressure switch was closed with no call for combustion fan.	Alarm only
Combustion fan not proved	Indicates a call for low speed combustion fan but low pressure switch did not close.	Alarm only
IG furnace max retry	Indicates that the max number of retries was reached.	Alarm and Furnace lockout
IG High Temp AL	Indicates that power was lost from the High Temp Limit Sensor. Check for high limit trip.	Alarm only
IG offline	Indicates communication with furnace control has failed.	Alarm only
IG Lg Man No Flame AL	No flame after 3 trials for ignition on the large manifold.	Alarm only

## Appendix A: Remote Display (pGD1)

The pGD1 is an optional remote display for use with manufacturer’s microprocessor controllers. The remote display allows for remote monitoring and adjustment of parameters of the unit mounted controller. The remote display allows identical access to menus and screens as the unit mounted controller display.



Specifications	
Carel Model	PGD1000W00
Power Supply	Power supplied from unit controller through RJ25 cable
Max distance from unit controller	150 feet
Required Cable	6P6C RJ25/RJ12 Cable (straight)
Operating Conditions	-4°F to 140°F, 90%RH (non-condensing)
Display Type	Backlit LED with lighted buttons

### Installation

The remote display connects to the unit mounted controller through a six-wire RJ25 or RJ12 telephone cable (straight). When ordered from the factory, a 10 ft. cable is provided with the remote display. The display and cable can be used to assist with start-up and maintenance.

### Connecting Cable

If mounted remotely, the factory cable can either be extended or replaced with a longer cable to obtain the necessary distance. The resulting cable connections should be a “straight through cable,” where pins on one end correspond identically to the pins on the opposite end. If making your own cable, use the same pin-out for each end.

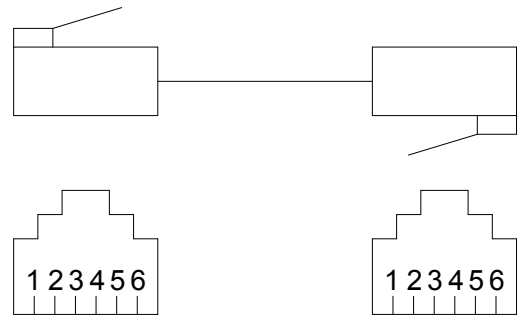

## NTC Temperature Sensor Chart

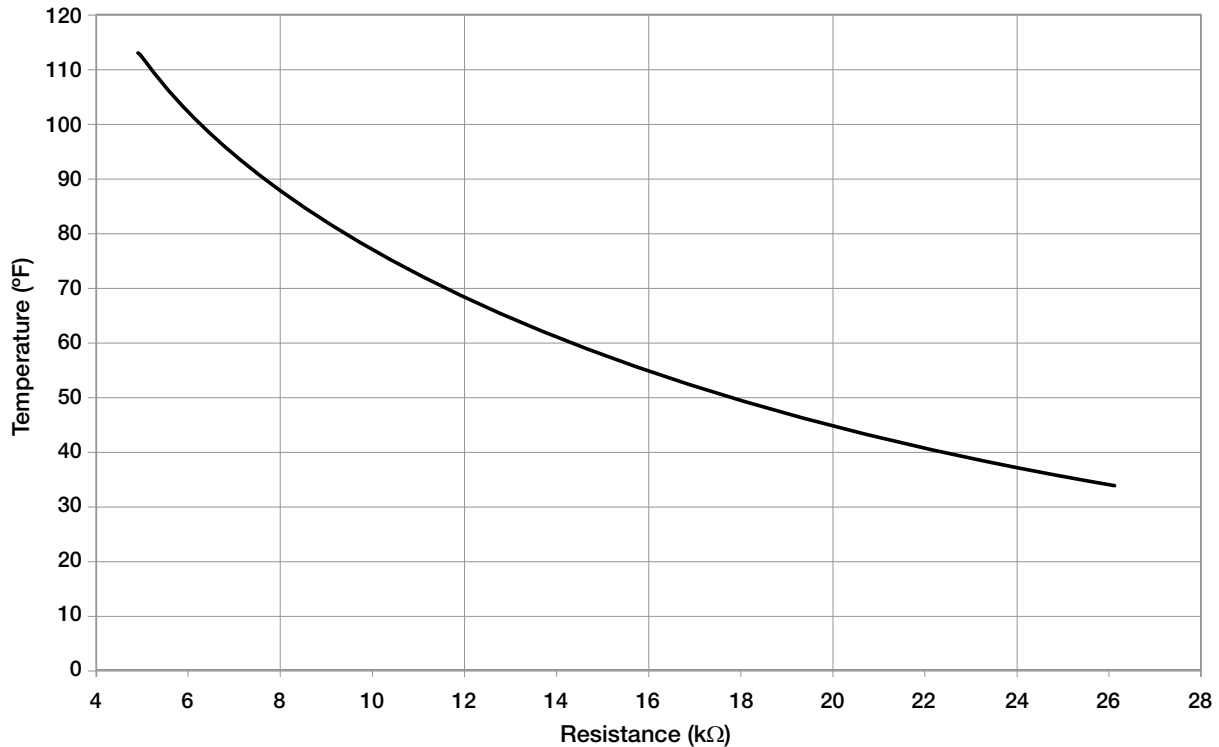



## Appendix B: I/O Expansion Board (c.pCOe) Quick Start

The expansion board is an I/O module that can be used to monitor additional statuses or provide commands from large board controller. It allows the user to view and control:

- 6 Universal Inputs (Digital Input\*, NTC, 0/1VDC, 0/10VDC, 0/20mA, 4/20mA, 0/5VDC)  
\*Only dry to ground contacts can be utilized for digital inputs. Applying voltage will result in damage to the I/O expansion board.
- 4 Analog Outputs (VDC)
- 6 Digital Outputs

The inputs and outputs can be monitored and controlled by the Building Management System. Reference Points List for detailed point information.

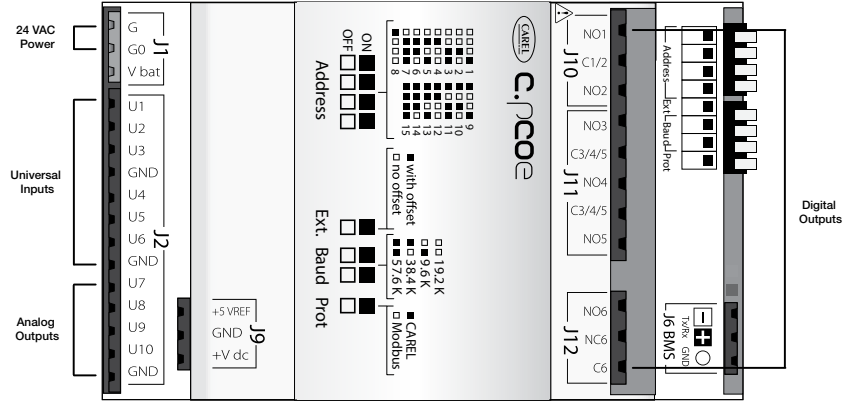

### Setup

In order for the controller to communicate with the c.pCOe, several parameters must be adjusted. If you have a c.pCOe installed from the factory, the controller is already set up for communication with the main controller. The factory password is required for expansion board and I/O configuration updates. Consult factory for I/O configuration changes.

```

Expansion Type
EXP 1: Not Installed
EXP 2: Not Installed
EXP 3: Not Installed
EXP 4: cPcoE
EXP 5: Not Installed
EXP 6: Not Installed
**Reboot Controller**
    
```

```

AUX IO Installed
Installed: [X]

Enables AUX IO
Requires factory
programming.
    
```

```

I/O Conf Options
Editable: [X]
Scroll by
All Configured: [ ]
    
```

```

I/O Configuration
IO Type: Analog Input
Aux In Customer 5
Ch: E4 U5 Type: 0-10U
Min: 0.0°F
Max: 100.0°F
Value: 32.0°F
    
```

```

AUX I/O Config
Aux In Customer 5
Ch: E4 U5 UM: °F
Type: 0-10U
Min: 0.0°F
Max: 100.0°F
Value: 32.0°F
    
```

**Enabling the c.pCOe in the Main Controller.** - To enable the c.pCOe expansion I/O module, go to Ctrl Variables/Advanced/Unit Config. User will have to enter the Factory Password to make any edits at this point. Consult factory for factory password and configuring the expansion board. The expansion board must be enabled to configure spare I/O points. Once enabled, the user must reboot the controller. See screens to the left for expansion board enable points.

**Configuring the I/O Type** - In order to edit and configure the I/O configuration of the unit, go to Ctrl Variables/Advanced/I/O Configuration. The user must enable the Editable option for configuring I/O points. If configuring a new I/O point, 'Scroll by All Configured' must be deselected to view all I/O options.

**Change or Update the I/O Point** - Once the editable option is selected, the user must scroll to the I/O Configuration Menu. At this menu the desired I/O type can be selected. Once selected the user can configure the desired channel at the expansion board. The channel will have an 'E' designation for expansion board. Aux In Customer 1-6, Aux Analog Out 1-4, and Aux Digital Out 1-6 will be allocated for the I/O expansion board. See example to the left.

**Viewing c.pCOe Auxiliary Values** - Once the expansion board I/O is configured, the user can view and/or change the I/O type by navigating to Ctrl Variables/Aux I/O Config.

## Appendix C: Space Thermostat Quick Start



The space thermostat gives users the ability to view the space temperature and relative humidity (optional) and control the active space set points from the adjustable display. The space thermostat also has the ability to send the unit into temporary occupied mode. It is also provides the functionality to average up to 4 temperature readings through the microprocessor. The space thermostat is shipped loose with installation by others and is a Modbus connected device.

Room thermostat functions:

- Temporary occupancy override control
- Temperature and relative humidity monitoring
- Temperature and relative humidity set point adjustability
- Status icon on LCD display with push buttons
- Optional temperature monitoring up to 4 sensors

### Display

If more than one space thermostat is provided for averaging, only one space thermostat will be provided with a display and push buttons for adjustment.

**Adjusting SET POINT** - The default display will show the current temperature value for the room. Use the scroll button to index through additional sensor parameters. Parameters with the "SET POINT" icon displayed above the temperature display are adjustable. Use the Up/Down buttons to adjust the set point, and use the scroll button to view the next parameter or return to the normal display mode.

**Up/Down Button Function** - The Up/Down buttons are used to adjust editable parameters including the temperature and humidity set point.

**Override Button Function** - The display shows a person in the lower left corner of the display at all times. If the person is solid, the unit is operating in occupied mode. If it is an outline of the person, the unit is in unoccupied mode. Pushing the Override button when the unit is in unoccupied mode will allow a temporary override sequence to Occupied mode for a period of 1 to 3 hours (adjustable at the unit microprocessor).

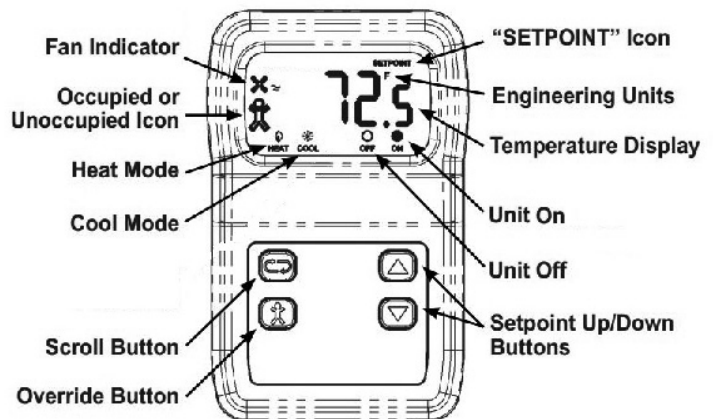

### Initial Setup and Communication Configuration

The space thermostat is a Modbus connected device. There can be up to three additional Modbus temperature sensors added for space temperature averaging. The sensors must all be connected in a daisy chain configuration.

The microprocessor controller will be pre-configured for one space thermostat. If space temperature averaging is desired, additional field setup will be required both in the controller and on the Modbus space sensors:

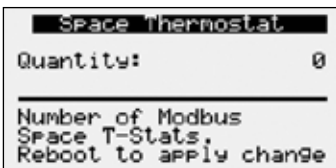

- Each space sensor must have the DIP switches adjusted on the back of the sensor to the corresponding switches. Reference Room Thermostat Modbus Address chart on the following page for DIP switches settings.
- Once the address is set and the wires are connected the "Status" LED should be a steady green and the "Network" LED should be a quick blinking amber/green color.
- In the Controller, enter the Ctrl Variables Menu/Temperature and scroll down in the Temperature Menu to select Space Thermostat. Choose the number of space sensor being used (1-4).

## Appendix C: Space Thermostat Quick Start



### Status LED

Green indicates that the unit is operating properly.  
Red indicates that there is a problem with the unit.

Terminal	Description
GND	Power Supply Ground (common to the controller)
Net B	RS485 network connection (Data -)
Net A	RS485 network connection (Data +)
Power	Power supply hot

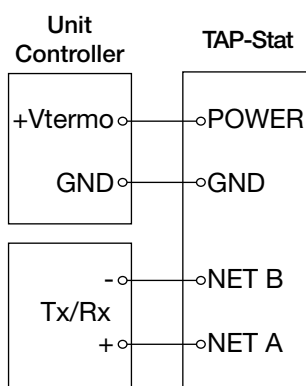

### Network LED

**Flashing Red Slowly** indicates that there has been no communications for 60 seconds.  
**Flashing Green Slowly** indicates that there have been normal communications within the last 60 seconds.  
**Flashing Green Slowly with Quick Red Flashes;** the quick red flashes indicate active communications.

Space Thermostat Modbus Address				
	T-Stat 1 (Display)	T-Stat 2	T-Stat 3	T-Stat 4
Address in Microprocessor	10	11	12	13
Dip Switch Set on Stat	Sw 2 + Sw 8	Sw 1 + Sw 2 + Sw 8	Sw 4 + Sw 8	Sw 1 + Sw 4

## Baud Rate Setting

In order for the space thermostat to communicate with the microprocessor, the correct baud rate must be set in the space thermostat. To set the baud rate:

- The “PROG” DIP switch on the back of the space thermostat must be flipped to the right side.
- Use the Set Point Down button to display P11 on the space thermostat.
- Push the Scroll button and use the Set Point Up/Down buttons to adjust the baud rate to 192.
- Once 192 is displayed, push the Scroll button again to save the setting. Once the setting is saved, P11 should appear on the display.
- Flip the “PROG” DIP switch on the back of the space thermostat back to the left. The space thermostat should communicate and be set back to normal mode.

## Occupancy Override Time Adjustment

If the occupancy override time needs to be adjusted:

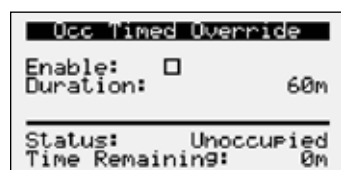

- If the occupancy override is enabled from the space thermostat or the unit microprocessor, it will override for the period of time set on this menu screen.
- To adjust the temperature override time, enter the following menu options at the controller, Ctrl Variables/Occupancy. Scroll down at the Occupancy Menu and select Occ Timed Override. This menu will allow the user to enable occupancy override from the controller and set override duration.

## Appendix D: GreenTrol® Airflow Monitoring Quick Start

Airflow Status	
Exh Fan:	0
OAD:	0

The GreenTrol® airflow monitoring station measures airflow using advanced thermal dispersion technology. An integral LCD display provides a local indication of airflow measurement and device configuration. The airflow monitor also features Modbus communication allowing the main unit microprocessor to monitor the airflow as well. The GreenTrol also accepts up to two airflow probes for averaging.

GreenTrol Airflow Monitor functions:

- LCD readout of measured airflow
- Dual airflow probe averaging
- Modbus connectivity



### Display and Navigation

The LCD screen will by default show the current airflow that is being measured. To enter the menu to set up the monitoring station the user must remove the front cover of the GreenTrol to uncover the navigation buttons. Press and hold the UP and DOWN buttons at the same time for 3 seconds to enter the menu.

**Enter Button Function** - The ENTER button allows the user to go into the selected menu or function, as well as save the selected value.

**Up/Down Button Function** - The Up/Down buttons are used to navigate the menu and to change values in the menu.

**Esc Button Function** - The ESC button allows the user to exit the current menu or function.

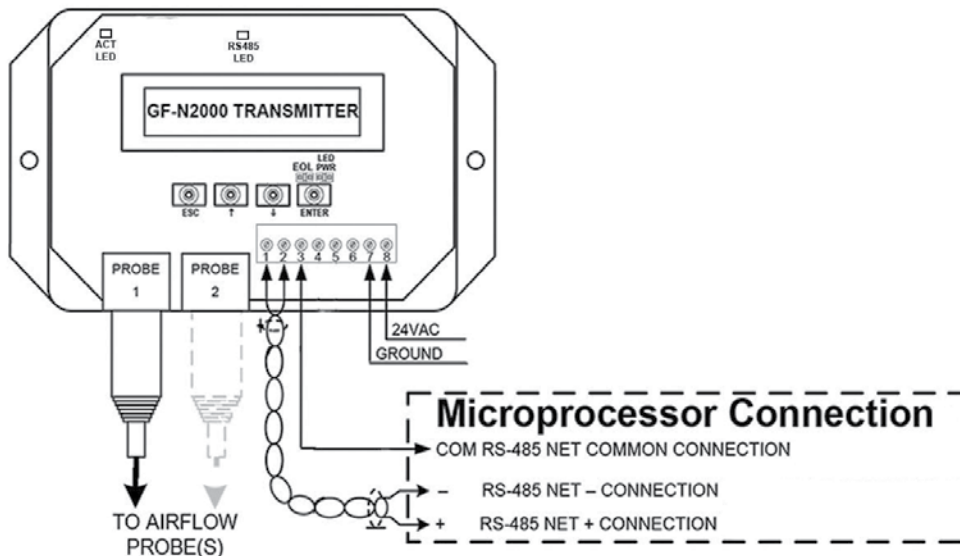

## Appendix E: Points List

VARIABLE	DESCRIPTION	ACTIVE TEXT	INACTIVE TEXT	BACNET				MODBUS		
				OBJECT INSTANCE	OBJECT TYPE	ACCESS	HYST	INDEX	REGISTER TYPE	SIZE
Analog Inputs - Read Only										
Circuit_A_Discharge_Temp_Analog_Input	Circuit A Discharge Temperature			1	AI	ReadCOV_NoWrite	0.1	30195	Input	2
Circuit_A_Suction_Temp_Analog_Input	Circuit A Suction Temperature			3	AI	ReadCOV_NoWrite	0.1	30199	Input	2
Cold_Coil_1_Temp_Analog_Input	Cold Coil 1 Temperature			25	AI	ReadCOV_NoWrite	0.1	30243	Input	2
CL_Coil_Spt_Temp	Controls Lite Cooling Coil Set Point Temperature value			31	AI	ReadCOV_NoWrite	0.1	30255	Input	2
CL_Supply_Spt_Temp	Controls Lite Supply Set Point Temperature value			32	AI	ReadCOV_NoWrite	0.1	30257	Input	2
Outside_Air_Temp_Analog_Input	Outside Air Temperature			37	AI	ReadCOV_NoWrite	0.1	30267	Input	2
Space_Temp_Analog_Input	Space Temperature			44	AI	ReadCOV_NoWrite	0.1	30281	Input	2
Supply_Temp_Analog_Input	Supply Temperature			45	AI	ReadCOV_NoWrite	0.1	30283	Input	2
Outside_RH_Analog_Input	Outside % Relative Humidity			86	AI	ReadCOV_NoWrite	0.1	30349	Input	2
Space_RH_Analog_Input	Space % Relative Humidity			89	AI	ReadCOV_NoWrite	0.1	30355	Input	2
Space_Static_Pressure_Analog_Input	Space Static Pressure			94	AI	ReadCOV_NoWrite	0.01	30365	Input	2
Supply_Duct_Static_Pressure_Analog_Input	Supply Duct Static Pressure			95	AI	ReadCOV_NoWrite	0.01	30367	Input	2
Space_CO2_1_Analog_Input	Space 1 CO2 ppm			116	AI	ReadCOV_NoWrite	10	30401	Input	2
Circuit_A_Discharge_Pressure_Analog_Input	Circuit A Discharge Pressure			119	AI	ReadCOV_NoWrite	0.1	30407	Input	2
Circuit_A_Suction_Pressure_Analog_Input	Circuit A Suction Pressure			120	AI	ReadCOV_NoWrite	0.1	30409	Input	2
Circuit_B_Discharge_Pressure_Analog_Input	Circuit B Discharge Pressure			121	AI	ReadCOV_NoWrite	1	30411	Input	2
Aux_In_Customer_1	Customer defined auxiliary input			640	AI	ReadCOV_NoWrite	0.1	30639	Input	2
Aux_In_Customer_2	Customer defined auxiliary input			642	AI	ReadCOV_NoWrite	0.1	30641	Input	2
Aux_In_Customer_3	Customer defined auxiliary input			644	AI	ReadCOV_NoWrite	0.1	30643	Input	2
Aux_In_Customer_4	Customer defined auxiliary input			646	AI	ReadCOV_NoWrite	0.1	30645	Input	2
Aux_In_Customer_5	Customer defined auxiliary input			648	AI	ReadCOV_NoWrite	0.1	30647	Input	2
Aux_In_Customer_6	Customer defined auxiliary input			650	AI	ReadCOV_NoWrite	0.1	30649	Input	2

## Appendix E: Points List

VARIABLE	DESCRIPTION	ACTIVE TEXT	INACTIVE TEXT	BACNET				MODBUS		
				OBJECT INSTANCE	OBJECT TYPE	ACCESS	HYST	INDEX	REGISTER TYPE	SIZE
Analog Values - Read/Write - Commandable										
Temperature_Set Point	Main Temperature Set point. Supply, Space, or Return target temperature			1	AV	ReadCOV_Commandable	0	40001	Holding	2
Temperature_Heat_Cool_Deadband	Heat/Cool Spt Deadband when Room or Return control is active. Clg Spt = Deadband /2 + Temp Spt. Htg Spt = Deadband /2 - Temp Spt.			2	AV	ReadCOV_Commandable	0	40003	Holding	2
Cooling_Coil_Set Point_Min	Cooling Coil Leaving Air Set Point			3	AV	ReadCOV_Commandable	0	40005	Holding	2
Dehumidification_Set Point	Dehumidification Set Point. %RH for Space or Return control.			5	AV	ReadCOV_Commandable	0	40009	Holding	2
Outside_Dewpoint_Set Point	Outside Dewpoint Dehumidification Trigger Set Point			6	AV	ReadCOV_Commandable	0	40011	Holding	2
Indoor_Dewpoint_Set Point	Indoor Dewpoint Dehumidification Trigger Set Point			7	AV	ReadCOV_Commandable	0	40013	Holding	2
Unocc_Indoor_Dewpoint_Set Point	Unoccupied Indoor Dewpoint Dehumidification Trigger Set Point			9	AV	ReadCOV_Commandable	0	40017	Holding	2
Unoccupied_Cooling_Set Point	Unoccupied Cooling Set Point			10	AV	ReadCOV_Commandable	0	40019	Holding	2
Unoccupied_Dehumidification_Set Point	Unoccupied Dehumidification %RH Set Point			11	AV	ReadCOV_Commandable	0	40021	Holding	2
Unoccupied_Heating_Set Point	Unoccupied Heating Set Point			12	AV	ReadCOV_Commandable	0	40023	Holding	2
Economizer_Temp_Enable_Set Point	Economizer Ambient Temp Enable Set Point. Allow Econ when OAT<Spt			16	AV	ReadCOV_Commandable	0	40031	Holding	2
Economizer_Enthalpy_Enable_Set Point	Economizer Enthalpy Enable Set Point. Allow Econ when OA Enthalpy<Spt			17	AV	ReadCOV_Commandable	0	40033	Holding	2
Outside_RH_from_BMS	Outside RH from BMS. Used when source selection is set to BMS.			21	AV	ReadCOV_Commandable	0.1	40041	Holding	2
Outside_Temp_from_BMS	Outside Temp from BMS. Used when source selection is set to BMS.			22	AV	ReadCOV_Commandable	0.1	40043	Holding	2
Return_RH_from_BMS	Return RH from BMS. Used when source selection is set to BMS.			23	AV	ReadCOV_Commandable	0.1	40045	Holding	2
Return_Temp_from_BMS	Return Temp from BMS. Used when source selection is set to BMS.			24	AV	ReadCOV_Commandable	0.1	40047	Holding	2
Space_1_CO2_from_BMS	Space 1 CO2 from BMS. Used when source selection is set to BMS.			25	AV	ReadCOV_Commandable	0.1	40049	Holding	2
Space_RH_from_BMS	Space RH from BMS. Used when source selection is set to BMS.			28	AV	ReadCOV_Commandable	0.1	40055	Holding	2
Space_Static_from_BMS	Space Static from BMS. Used when source selection is set to BMS.			29	AV	ReadCOV_Commandable	0.1	40057	Holding	2
Space_Temp_from_BMS	Space Temp from BMS. Used when source selection is set to BMS.			30	AV	ReadCOV_Commandable	0.1	40059	Holding	2
Cooling_Lockout_Set Point	Cooling Ambient Lockout Set Point			31	AV	ReadCOV_Commandable	0.1	40061	Holding	2
Heating_Lockout_Set Point	Heating Ambient Lockout Set Point			32	AV	ReadCOV_Commandable	0.1	40063	Holding	2
Space_Static_Pressure_Set Point	Space Static Pressure Set Point			37	AV	ReadCOV_Commandable	0.1	40073	Holding	2

## Appendix E: Points List

VARIABLE	DESCRIPTION	ACTIVE TEXT	INACTIVE TEXT	BACNET				MODBUS		
				OBJECT INSTANCE	OBJECT TYPE	ACCESS	HYST	INDEX	REGISTER TYPE	SIZE
Supply_Duct_Static_Pressure_Set Point	Supply Duct Static Pressure Set Point			38	AV	ReadCOV_Commandable	0.1	40075	Holding	2
Space_CO2_Set Point	Space CO2 Set Point			39	AV	ReadCOV_Commandable	0.1	40077	Holding	2
SF_Control_Signal_BMS	BMS to control signal for supply fan speed			133	AV	ReadCOV_Commandable	0.1	40083	Holding	2
EF_Control_Signal_BMS	BMS to control signal for exhaust fan speed			134	AV	ReadCOV_Commandable	0.1	40085	Holding	2
OAD_Control_Signal_BMS	Allows the BMS to control OAD position. True = BMS. False = Local.			136	AV	ReadCOV_Commandable	0.1	40089	Holding	2
Outside_Air_Damper_Minimum_Set Point	Outside Air Damper Minimum Set Point			137	AV	ReadCOV_Commandable	1	40091	Holding	2
Aux_BMS_Analog_Output_1	BMS Commanded auxiliary analog output			138	AV	ReadCOV_Commandable	0.1	40093	Holding	2
Aux_BMS_Analog_Output_2	BMS Commanded auxiliary analog output			139	AV	ReadCOV_Commandable	0.1	40095	Holding	2
Aux_BMS_Analog_Output_3	BMS Commanded auxiliary analog output			140	AV	ReadCOV_Commandable	0.1	40097	Holding	2
Aux_BMS_Analog_Output_4	BMS Commanded auxiliary analog output			141	AV	ReadCOV_Commandable	0.1	40099	Holding	2
Cooling_Coil_Setpoint_Max	Maximum Coil Leaving Setpoint			313	AV	ReadCOV_Commandable	0.1	40101	Holding	2

## Appendix E: Points List

VARIABLE	DESCRIPTION	ACTIVE TEXT	INACTIVE TEXT	BACNET				MODBUS		
				OBJECT INSTANCE	OBJECT TYPE	ACCESS	HYST	INDEX	REGISTER TYPE	SIZE
Analog Values - Read Only										
Unit_Status_Mode	0: Off/Standby 1: Unoccupied Start 2: Occupied Start 5: Dampers Open 6: Fan Start Delay 7: Fans Starting 9: Heat/Cool Delay 10: System On 11: Soft Shutdown 12: System Disabled 13: Remote Off 14: Shutdown Alarm 19: Fans Only 20: Economizing 21: Cooling 22: Heating 23: Dehumidifying 25: HGRH Purging 26: Defrost Active 28: Cooling & Heating 29: Dehum w/Heat 30: Overrides Active 31: Expansion Offline 51: IO Test. Sys Disabled			40	AV	ReadCOV_NoWrite	0	30001	Input	2
Supply_Temperature_Calculated_Set Point	Active Supply Temperature Set Point			41	AV	ReadCOV_NoWrite	0.1	30003	Input	2
Cooling_1_Ramp_Capacity	Cooling Ramp 1 Status Value			43	AV	ReadCOV_NoWrite	1	30007	Input	2
Defrost_Ramp	Defrost Ramp			47	AV	ReadCOV_NoWrite	1	30015	Input	2
Economizer_Ramp	Economizer Ramp			48	AV	ReadCOV_NoWrite	1	30017	Input	2
Exhaust_Fan_Space_Static_Pressure_Ramp	Exhaust Fan Space Static Pressure Ramp			49	AV	ReadCOV_NoWrite	1	30019	Input	2
Exhaust_Fan_Supply_Tracking_Ramp	Exhaust Fan Supply Tracking Ramp			50	AV	ReadCOV_NoWrite	1	30021	Input	2
Head_Pressure_Control_Ramp_1_Ramp	Head Pressure Control Ramp 1			51	AV	ReadCOV_NoWrite	1	30023	Input	2
Head_Pressure_Control_Ramp_2_Ramp	Head Pressure Control Ramp 2			52	AV	ReadCOV_NoWrite	1	30025	Input	2
HP_Ramp_Capacity	Heat Pump Heating Ramp			59	AV	ReadCOV_NoWrite	1	30039	Input	2
Heating_Ramp	Heating Ramp			60	AV	ReadCOV_NoWrite	1	30041	Input	2
Hot_Gas_Reheat_Ramp	Hot Gas Reheat Ramp			61	AV	ReadCOV_NoWrite	1	30043	Input	2
Space_CO2_Control_Ramp	Space CO2 Control Ramp			71	AV	ReadCOV_NoWrite	1	30063	Input	2
Supply_Duct_Static_Pressure_Ramp	Supply Duct Static Pressure Ramp			72	AV	ReadCOV_NoWrite	1	30065	Input	2
Supply_Fan_Space_Static_Pressure_Ramp	Supply Fan Space Static Pressure Ramp			74	AV	ReadCOV_NoWrite	1	30069	Input	2
Winter_Ramp_Output	Winter Ramp Output			75	AV	ReadCOV_NoWrite	1	30071	Input	2
Outside_Dewpoint	Outside Dewpoint			82	AV	ReadCOV_NoWrite	0.1	30085	Input	2
Outside_Enthalpy	Outside Enthalpy			83	AV	ReadCOV_NoWrite	0.1	30087	Input	2
Return_Dewpoint	Return Dewpoint			86	AV	ReadCOV_NoWrite	0.1	30093	Input	2
Return_Enthalpy	Return Enthalpy			87	AV	ReadCOV_NoWrite	0.1	30095	Input	2
Space_Dewpoint	Space Dewpoint			88	AV	ReadCOV_NoWrite	0.1	30097	Input	2
Space_Enthalpy	Space Enthalpy			89	AV	ReadCOV_NoWrite	0.1	30099	Input	2



## Appendix E: Points List

VARIABLE	DESCRIPTION	ACTIVE TEXT	INACTIVE TEXT	BACNET				MODBUS		
				OBJECT INSTANCE	OBJECT TYPE	ACCESS	HYST	INDEX	REGISTER TYPE	SIZE
Circuit_A_Superheat	Circuit A Superheat			93	AV	ReadCOV_NoWrite	0.1	30107	Input	2
Total_Exhaust_Fan_CFM_BMS	Total Exhaust Fan CFM			107	AV	ReadCOV_NoWrite	10	30135	Input	2
OAD_CFM_BMS	OAD CFM			129	AV	ReadCOV_NoWrite	10	30173	Input	2
OAD_Space_Static_Pressure_Ramp	OAD Static Pressure Ramp			131	AV	ReadCOV_NoWrite	1	30177	Input	2
Active_Temperature_Set Point	Active Temperature Set point			132	AV	ReadCOV_NoWrite	0.1	30179	Input	2
Chilled_Water_1_Valve_Analog_Output	Chilled Water 1 Valve Analog Output			201	AV	ReadCOV_NoWrite	0.1	30473	Input	2
Condenser_1_Analog_Output	Condenser 1 Analog Output			205	AV	ReadCOV_NoWrite	0.1	30481	Input	2
Condenser_2_Analog_Output	Condenser 2 Analog Output			206	AV	ReadCOV_NoWrite	0.1	30483	Input	2
Electric_Heater_1_Analog_Output	Electric Heater 1 Analog Output			221	AV	ReadCOV_NoWrite	0.1	30513	Input	2
Energy_Recovery_Analog_Output	Energy Recovery Analog Output			229	AV	ReadCOV_NoWrite	0.1	30517	Input	2
Exhaust_Fan_Speed_Analog_Output	Exhaust Fan Speed Analog Output			231	AV	ReadCOV_NoWrite	0.1	30521	Input	2
Hot_Gas_Reheat_Analog_Output	Hot Gas Reheat Analog Output			235	AV	ReadCOV_NoWrite	0.1	30523	Input	2
Hot_Water_Valve_1_Analog_Output	Hot Water Valve 1 Analog Output			236	AV	ReadCOV_NoWrite	0.1	30525	Input	2
Mod_Gas_Furnace_1_Analog_Output	Mod Gas Furnace 1 Analog Output			242	AV	ReadCOV_NoWrite	0.1	30537	Input	2
Outside_Air_Damper_Analog_Output	Outside Air Damper Analog Output			250	AV	ReadCOV_NoWrite	0.1	30541	Input	2
Supply_Fan_Speed_Analog_Output	Supply Fan Speed Analog Output			264	AV	ReadCOV_NoWrite	0.1	30557	Input	2
Modulating_Compressor_Analog_Output_BMS	Modulating Compressor Analog Output - BMS			285	AV	ReadCOV_NoWrite	0.1	30585	Input	2
Circuit_A_Sat_Discharge_Temperature	Circuit A Saturated Discharge Temperature			286	AV	ReadCOV_NoWrite	0.1	30587	Input	2
Circuit_B_Sat_Discharge_Temperature	Circuit B Saturated Discharge Temperature			287	AV	ReadCOV_NoWrite	0.1	30589	Input	2
Circuit_A_Sat_Suction_Temperature	Circuit A Saturated Suction Temperature			294	AV	ReadCOV_NoWrite	0.1	30603	Input	2
Coil_Temperature_Calculated_Setpoint	Calculated Coil Leaving Setpoint			312	AV	ReadCOV_NoWrite	0.1	30653	Input	2

## Appendix E: Points List

VARIABLE	DESCRIPTION	ACTIVE TEXT	INACTIVE TEXT	BACNET				MODBUS		
				OBJECT INSTANCE	OBJECT TYPE	ACCESS	HYST	INDEX	REGISTER TYPE	SIZE
<b>Binary Inputs - Read Only</b>										
Exhaust_Fan_1_Status_Digital_Input	Exhaust Fan 1 Status	Active	Inactive	23	BI	ReadCOV_NoWrite	0	24	Discrete	
Comp_Circ_A_High_Pressure_Digital_Input	Circuit A High Pressure Switch	Active	Inactive	3	BI	ReadCOV_NoWrite	0	10052	Discrete	
Comp_Circ_A_Low_Pressure_Digital_Input	Circuit A Low Pressure Switch	Active	Inactive	4	BI	ReadCOV_NoWrite	0	10053	Discrete	
Comp_Circ_B_High_Pressure_Digital_Input	Circuit B High Pressure Switch	Active	Inactive	5	BI	ReadCOV_NoWrite	0	10054	Discrete	
Comp_Circ_B_Low_Pressure_Digital_Input	Circuit B Low Pressure Switch	Active	Inactive	6	BI	ReadCOV_NoWrite	0	10055	Discrete	
Drain_Pan_Alarm_Digital_Input	Drain Pan Alarm Digital Input Status	Active	Inactive	21	BI	ReadCOV_NoWrite	0	10070	Discrete	
Occupancy_Digital_Input	Occupancy Digital Input Status	Active	Inactive	53	BI	ReadCOV_NoWrite	0	54	Discrete	
Outside_Filter_Alarm_Digital_Input	Outside Filter Alarm Digital Input Status	Active	Inactive	54	BI	ReadCOV_NoWrite	0	55	Discrete	
Shutdown_Alarm_Digital_Input	Shutdown Alarm Digital Input Status	Active	Inactive	75	BI	ReadCOV_NoWrite	0	76	Discrete	
Supply_Fan_1_Status_Digital_Input	Supply Fan 1 Status	Active	Inactive	78	BI	ReadCOV_NoWrite	0	79	Discrete	
Unit_Enable_Digital_Input	Remote Unit Enable Digital Input Status	Active	Inactive	82	BI	ReadCOV_NoWrite	0	83	Discrete	
Wheel_Status_Digital_Input	Heat Wheel Status	Active	Inactive	83	BI	ReadCOV_NoWrite	0	84	Discrete	
<b>Binary Values - Read/Write - Commandable</b>										
BMS_Watchdog	BMS Watchdog command. Used to determine comm status. Must heartbeat within the watchdog timeout delay to detect comm status.	Active	Inactive	1	BV	Read_Commandable	0	2	Coil	
System_Enable	Master system enable/disable point.	Enable	Disable	2	BV	Read_Commandable	0	3	Coil	
BMS_Occupancy_Command	Occupancy Command. True = Unoccupied. False = Occupied.	Unoccupy	Occupy	3	BV	Read_Commandable	0	4	Coil	
Reset_All_Alarms	Alarm Reset Command.	Reset	Normal	4	BV	Read_Commandable	0	5	Coil	
Outside_RH_Source_BMS	Outside RH Source Selection. True = BMS. False = Local.	BMS	Local	5	BV	Read_Commandable	0	6	Coil	
Outside_Temp_Source_BMS	Outside Temp Source Selection. True = BMS. False = Local.	BMS	Local	6	BV	Read_Commandable	0	7	Coil	
Return_RH_Source_BMS	Return RH Source	BMS	Local	7	BV	Read_Commandable	0	8	Coil	
Return_Temp_Source_BMS	Return Temp Source	BMS	Local	8	BV	Read_Commandable	0	9	Coil	
Space_1_CO2_Source_BMS	Space 1 CO2 Source Selection. True = BMS. False = Local.	BMS	Local	9	BV	Read_Commandable	0	10	Coil	
Space_RH_Source_BMS	Space RH Source Selection. True = BMS. False = Local.	BMS	Local	12	BV	Read_Commandable	0	13	Coil	
Space_Static_Source_BMS	Space Static Source Selection. True = BMS. False = Local.	BMS	Local	13	BV	Read_Commandable	0	14	Coil	
Space_Temp_Source_BMS	Space Temp Source Selection. True = BMS. False = Local.	BMS	Local	14	BV	Read_Commandable	0	15	Coil	
SF_Control_Source_BMS	Allows the BMS to control supply fan speed. True = BMS. False = Local.	BMS	Local	56	BV	Read_Commandable	0	19	Coil	
EF_Control_Source_BMS	Allows the BMS to control exhaust fan speed. True = BMS. False = Local.	BMS	Local	57	BV	Read_Commandable	0	20	Coil	
OAD_Control_Source_BMS	Allows the BMS to control OAD position. True = BMS. False = Local.	BMS	Local	59	BV	Read_Commandable	0	22	Coil	

## Appendix E: Points List

VARIABLE	DESCRIPTION	ACTIVE TEXT	INACTIVE TEXT	BACNET				MODBUS		
				OBJECT INSTANCE	OBJECT TYPE	ACCESS	HYST	INDEX	REGISTER TYPE	SIZE
Binary Values - Read Only										
Occupied	Occupied Status.	Occupied	Unoccupied	16	BV	ReadCOV_NoWrite	0	10002	Discrete	
Unoccupied	Unoccupied Status.	Unoccupied	Occupied	17	BV	ReadCOV_NoWrite	0	10003	Discrete	
Unoccupied_Cooling_Call	Unoccupied Cooling Call Status	Active	Inactive	18	BV	ReadCOV_NoWrite	0	10004	Discrete	
Unoccupied_Dehumidification_Call	Unoccupied Dehumidification Call Status	Active	Inactive	19	BV	ReadCOV_NoWrite	0	10005	Discrete	
Unoccupied_Heating_Call	Unoccupied Heating Call Status	Active	Inactive	20	BV	ReadCOV_NoWrite	0	10006	Discrete	
Occupied_Start	Occupied Start Command Status	Active	Inactive	21	BV	ReadCOV_NoWrite	0	10007	Discrete	
Unoccupied_Start	Unoccupied Start Command Status	Active	Inactive	22	BV	ReadCOV_NoWrite	0	10008	Discrete	
Enable_Controls	Status to indicate startup is complete and the unit is ready.	Enabled	Disabled	23	BV	ReadCOV_NoWrite	0	10009	Discrete	
Global_Alarm	General alarm point. Optionally set to indicate any alarm is active, or a shutdown alarm is active.	Alarm	Normal	24	BV	ReadCOV_NoWrite	0	10010	Discrete	
System_Shutdown_Alarm	Shutdown alarm status. When true, System Enable will be set to false and the unit will remain off.	Shutdown	Normal	25	BV	ReadCOV_NoWrite	0	10011	Discrete	
Damper_Open	Indicates there is a open air path and the supply fan can run.	Open	Closed	26	BV	ReadCOV_NoWrite	0	10012	Discrete	
Cooling_is_On	Indicates that the unit is cooling.	Active	Inactive	27	BV	ReadCOV_NoWrite	0	10013	Discrete	
Economizer_is_On	Indicates that the unit is economizing.	Active	Inactive	28	BV	ReadCOV_NoWrite	0	10014	Discrete	
Heating_is_On	Indicates that the unit is heating.	Active	Inactive	29	BV	ReadCOV_NoWrite	0	10015	Discrete	
Dehumidification_Mode_Enabled	Indicates that the unit is dehumidifying.	Active	Inactive	31	BV	ReadCOV_NoWrite	0	10017	Discrete	
Manual_Override_Active	Indicates that manual overrides are active.	Override	Normal	32	BV	ReadCOV_NoWrite	0	10018	Discrete	
Cooling_Not_Locked_Out	Indicates that cooling is allowed.	Allowed	Locked_Out	33	BV	ReadCOV_NoWrite	0	10019	Discrete	
Heating_Not_Locked_Out	Indicates that heating is allowed.	Allowed	Locked_Out	34	BV	ReadCOV_NoWrite	0	10020	Discrete	
Preheat_Not_Locked_Out	Indicates that preheat is allowed.	Allowed	Locked_Out	36	BV	ReadCOV_NoWrite	0	10022	Discrete	
HGRH_Purging	Indicates that the hot gas reheat value is purging.	Active	Inactive	37	BV	ReadCOV_NoWrite	0	10023	Discrete	
Allow_Dampers	Startup sequence command to open dampers	Yes	No	43	BV	ReadCOV_NoWrite	0	10029	Discrete	
Allow_Exhaust_Fans	Startup sequence command to trigger exhaust fans to start	Yes	No	44	BV	ReadCOV_NoWrite	0	10030	Discrete	
Allow_Supply_Fans	Startup sequence command to trigger supply fans to start	Yes	No	48	BV	ReadCOV_NoWrite	0	10034	Discrete	
BMS_Watchdog_Active	Status of the BMS watchdog ping.	Active	Inactive	49	BV	ReadCOV_NoWrite	0	10035	Discrete	
BMS_Occupancy_Status	Status of the BMS occupancy command.	Occupied	Unoccupied	50	BV	ReadCOV_NoWrite	0	10036	Discrete	
Compressor_1_Enable_Digital_Output	Compressor 1 Enable Digital Output	Active	Inactive	111	BV	ReadCOV_NoWrite	0	10164	Discrete	
Compressor_2_Enable_Digital_Output	Compressor 2 Enable Digital Output	Active	Inactive	112	BV	ReadCOV_NoWrite	0	10165	Discrete	
Compressor_3_Enable_Digital_Output	Compressor 3 Enable Digital Output	Active	Inactive	113	BV	ReadCOV_NoWrite	0	10166	Discrete	

## Appendix E: Points List

VARIABLE	DESCRIPTION	ACTIVE TEXT	INACTIVE TEXT	BACNET				MODBUS		
				OBJECT INSTANCE	OBJECT TYPE	ACCESS	HYST	INDEX	REGISTER TYPE	SIZE
Compressor_4_Enable_Digital_Output	Compressor 4 Enable Digital Output	Active	Inactive	114	BV	ReadCOV_NoWrite	0	10167	Discrete	
Condenser_Fan_1_Digital_Output	Condenser Fan 1 Digital Output	Active	Inactive	119	BV	ReadCOV_NoWrite	0	10172	Discrete	
Condenser_Fan_2_Digital_Output	Condenser Fan 2 Digital Output	Active	Inactive	120	BV	ReadCOV_NoWrite	0	10173	Discrete	
Condenser_Fan_3_Digital_Output	Condenser Fan 3 Digital Output	Active	Inactive	121	BV	ReadCOV_NoWrite	0	10174	Discrete	
Exhaust_Fan_1_Start_Stop_Digital_Output	Exhaust Fan 1 Start Stop Digital Output	Active	Inactive	127	BV	ReadCOV_NoWrite	0	10180	Discrete	
Furnace_1_Stage_1_Digital_Output	Furnace 1 Stage 1 Digital Output	Active	Inactive	131	BV	ReadCOV_NoWrite	0	10184	Discrete	
Furnace_2_Stage_1_Digital_Output	Furnace 2 Stage 1 Digital Output	Active	Inactive	133	BV	ReadCOV_NoWrite	0	10186	Discrete	
Heat_Wheel_Enable_Digital_Output	Heat Wheel Enable Digital Output	Active	Inactive	163	BV	ReadCOV_NoWrite	0	10208	Discrete	
PreHeat_Enable_Digital_Output	PreHeat Enable Digital Output	Active	Inactive	166	BV	ReadCOV_NoWrite	0	10211	Discrete	
Supply_Fan_1_Start_Stop_Digital_Output	Supply Fan 1 Start Stop Digital Output	Active	Inactive	186	BV	ReadCOV_NoWrite	0	10231	Discrete	
BMS_Offline_Alarm.Active	BMS Offline Alarm (0=Normal 1=Alarm)	Alarm	Normal	313	BV	ReadCOV_NoWrite	0	10264	Discrete	
Circuit_A_Discharge_Pressure_Analog_Input_Alarm.Active	Circuit A Discharge Pressure Analog Input Alarm	Alarm	Normal	315	BV	ReadCOV_NoWrite		10266	Discrete	
Circuit_A_Discharge_Temp_Analog_Input_Alarm.Active	Circuit A Discharge Temp Analog Input Alarm	Alarm	Normal	316	BV	ReadCOV_NoWrite		10267	Discrete	
Circuit_A_Suction_Pressure_Analog_Input_Alarm.Active	Circuit A Suction Pressure Analog Input Alarm	Alarm	Normal	319	BV	ReadCOV_NoWrite		10270	Discrete	
Circuit_A_Suction_Temp_Analog_Input_Alarm.Active	Circuit A Suction Temp Analog Input Alarm	Alarm	Normal	320	BV	ReadCOV_NoWrite		10271	Discrete	
Circuit_B_Discharge_Pressure_Analog_Input_Alarm.Active	Circuit B Discharge Pressure Analog Input Alarm	Alarm	Normal	324	BV	ReadCOV_NoWrite		10275	Discrete	
Cold_Coil_1_Temperature_Sensor_Alarm.Active	Cold Coil 1 Temperature Sensor Alarm (0=Normal 1=Alarm)	Alarm	Normal	387	BV	ReadCOV_NoWrite	0	10338	Discrete	
Comp_Circ_A_High_Pressure_Alarm.Active	Comp Circ A High Pressure Alarm (0=Normal 1=Alarm)	Alarm	Normal	395	BV	ReadCOV_NoWrite	0	10346	Discrete	
Comp_Circ_A_Low_Pressure_Alarm.Active	Comp Circ A Low Pressure Alarm (0=Normal 1=Alarm)	Alarm	Normal	396	BV	ReadCOV_NoWrite	0	10347	Discrete	
Comp_Circ_B_High_Pressure_Alarm.Active	Comp Circ B High Pressure Alarm (0=Normal 1=Alarm)	Alarm	Normal	397	BV	ReadCOV_NoWrite	0	10348	Discrete	
Comp_Circ_B_Low_Pressure_Alarm.Active	Comp Circ B Low Pressure Alarm (0=Normal 1=Alarm)	Alarm	Normal	398	BV	ReadCOV_NoWrite	0	10349	Discrete	
Comp_Maintenance_Alarm.Active	Comp Maintenance Alarm (0=Normal 1=Alarm)	Alarm	Normal	411	BV	ReadCOV_NoWrite	0	10362	Discrete	
Drain_Pan_Alarm.Active	Drain Pan Alarm (0=Normal 1=Alarm)	Alarm	Normal	422	BV	ReadCOV_NoWrite	0	10372	Discrete	
Exhaust_Fan_1_Alarm.Active	Exhaust Fan 1 Alarm (0=Normal 1=Alarm)	Alarm	Normal	423	BV	ReadCOV_NoWrite	0	10373	Discrete	
Expansion_Board_1_Alarm.Active	Expansion Board 1 Alarm (0=Normal 1=Alarm)	Alarm	Normal	434	BV	ReadCOV_NoWrite	0	10384	Discrete	
Expansion_Board_2_Alarm.Active	Expansion Board 2 Alarm (0=Normal 1=Alarm)	Alarm	Normal	435	BV	ReadCOV_NoWrite	0	10385	Discrete	
Expansion_Board_3_Alarm.Active	Expansion Board 3 Alarm (0=Normal 1=Alarm)	Alarm	Normal	436	BV	ReadCOV_NoWrite	0	10386	Discrete	
Internal_Board_Temp_Alarm.Active	Internal Board Temp Alarm (0=Normal 1=Alarm)	Alarm	Normal	498	BV	ReadCOV_NoWrite	0	10448	Discrete	
Multi_Channel_Conf_Alarm.Active	Multi Channel Conf Alarm (0=Normal 1=Alarm)	Alarm	Normal	503	BV	ReadCOV_NoWrite	0	10453	Discrete	

## Appendix E: Points List

VARIABLE	DESCRIPTION	ACTIVE TEXT	INACTIVE TEXT	BACNET				MODBUS		
				OBJECT INSTANCE	OBJECT TYPE	ACCESS	HYST	INDEX	REGISTER TYPE	SIZE
Outside_Filter_Alarm.Active	Outside Filter Alarm (0=Normal 1=Alarm)	Alarm	Normal	508	BV	ReadCOV_NoWrite	0	10458	Discrete	
Outside_RH_Sensor_Alarm.Active	Outside RH Sensor Alarm (0=Normal 1=Alarm)	Alarm	Normal	509	BV	ReadCOV_NoWrite	0	10459	Discrete	
Space_CO2_1_Analog_Input_Alarm.Active	Space CO2 1 Analog Input Alarm (0=Normal 1=Alarm)	Alarm	Normal	535	BV	ReadCOV_NoWrite	0	10485	Discrete	
Space_High_Static_Alarm.Active	Space High Static Alarm (0=Normal 1=Alarm)	Alarm	Normal	537	BV	ReadCOV_NoWrite	0	10487	Discrete	
Space_RH_Sensor_Alarm.Active	Space RH Sensor Alarm (0=Normal 1=Alarm)	Alarm	Normal	538	BV	ReadCOV_NoWrite	0	10488	Discrete	
Space_SetPoint_Slider_Alarm.Active	Space Set Point Slider Alarm (0=Normal 1=Alarm)	Alarm	Normal	539	BV	ReadCOV_NoWrite	0	10489	Discrete	
Space_Static_Pressure_Analog_Input_Alarm.Active	Space Static Pressure Analog Input Alarm (0=Normal 1=Alarm)	Alarm	Normal	540	BV	ReadCOV_NoWrite	0	10490	Discrete	
Space_Temperature_Sensor_Alarm.Active	Space Temperature Sensor Alarm (0=Normal 1=Alarm)	Alarm	Normal	541	BV	ReadCOV_NoWrite	0	10491	Discrete	
Shutdown_Input_Alarm.Active	Shutdown Input Alarm (0=Normal 1=Alarm)	Alarm	Normal	546	BV	ReadCOV_NoWrite	0	10496	Discrete	
Supply_Air_Temp_Low_Limit.Active	Supply Air Temp Low Limit Alarm (0=Normal 1=Alarm)	Alarm	Normal	551	BV	ReadCOV_NoWrite	0	10501	Discrete	
Supply_Air_Temperature_Sensor_Alarm.Active	Supply Air Temperature Sensor Alarm (0=Normal 1=Alarm)	Alarm	Normal	552	BV	ReadCOV_NoWrite	0	10502	Discrete	
Supply_Duct_Static_Pressure_Analog_Input_Alarm.Active	Supply Duct Static Pressure Analog Input Alarm (0=Normal 1=Alarm)	Alarm	Normal	553	BV	ReadCOV_NoWrite	0	10503	Discrete	
Supply_Fan_1_Alarm.Active	Supply Fan 1 Alarm (0=Normal 1=Alarm)	Alarm	Normal	554	BV	ReadCOV_NoWrite	0	10504	Discrete	
Supply_High_Duct_Static_Alarm.Active	Supply High Duct Static Alarm (0=Normal 1=Alarm)	Alarm	Normal	563	BV	ReadCOV_NoWrite	0	10513	Discrete	
Supply_RH_Sensor_Alarm.Active	Supply RH Sensor Alarm (0=Normal 1=Alarm)	Alarm	Normal	564	BV	ReadCOV_NoWrite	0	10514	Discrete	
Supply_Temp_High_Limit_Alarm.Active	Supply Temp High Limit Alarm (0=Normal 1=Alarm)	Alarm	Normal	565	BV	ReadCOV_NoWrite	0	10515	Discrete	
TMem_Error.Active	TMem Error Alarm (0=Normal 1=Alarm)	Alarm	Normal	567	BV	ReadCOV_NoWrite	0	10517	Discrete	
Wheel_Rotation_Alarm.Active	Wheel Rotation Alarm (0=Normal 1=Alarm)	Alarm	Normal	576	BV	ReadCOV_NoWrite	0	10526	Discrete	
AI_Batt_EVD_1.Active	EVD Battery Alarm (0=Normal 1=Alarm)	Alarm	Normal	589	BV	ReadCOV_NoWrite	0	10539	Discrete	
AI_ConfigErr_EVD_1.Active	EVD Configuration Alarm (0=Normal 1=Alarm)	Alarm	Normal	590	BV	ReadCOV_NoWrite	0	10540	Discrete	
AI_DscgHiP_COMP_1.Active	Compressor Envelope - High Discharge Pressure Alarm (0=Normal 1=Alarm)	Alarm	Normal	591	BV	ReadCOV_NoWrite	0	10541	Discrete	
AI_DscgHiTemp_COMP_1.Active	Compressor Envelope - High Discharge Temperature Alarm (0=Normal 1=Alarm)	Alarm	Normal	592	BV	ReadCOV_NoWrite	0	10542	Discrete	
AI_DscgLowP_COMP_1.Active	EVD Low Discharge Pressure Alarm (0=Normal 1=Alarm)	Alarm	Normal	593	BV	ReadCOV_NoWrite	0	10543	Discrete	
AI_EEPROM_EVD_1.Active	EVD EEPROM Alarm (0=Normal 1=Alarm)	Alarm	Normal	594	BV	ReadCOV_NoWrite	0	10544	Discrete	
AI_EEV_A_EVD_1.Active	ExV Motor Alarm - Valve 1 (0=Normal 1=Alarm)	Alarm	Normal	595	BV	ReadCOV_NoWrite	0	10545	Discrete	
AI_EmergencyClosing_EVD_1.Active	EVD Emergency Closing Alarm (0=Normal 1=Alarm)	Alarm	Normal	597	BV	ReadCOV_NoWrite	0	10547	Discrete	
AI_EVD_Offline_EVD_1.Active	EVD Offline Communication Alarm (0=Normal 1=Alarm)	Alarm	Normal	598	BV	ReadCOV_NoWrite	0	10548	Discrete	
AI_FW_CompatibErr_EVD_1.Active	EVD Firmware Compability Alarm (0=Normal 1=Alarm)	Alarm	Normal	599	BV	ReadCOV_NoWrite	0	10549	Discrete	

## Appendix E: Points List

VARIABLE	DESCRIPTION	ACTIVE TEXT	INACTIVE TEXT	BACNET				MODBUS		
				OBJECT INSTANCE	OBJECT TYPE	ACCESS	HYST	INDEX	REGISTER TYPE	SIZE
AI_HiRatioP_COMP_1.Active	Compressor Envelope - High Pressure Ratio Alarm (0=Normal 1=Alarm)	Alarm	Normal	601	BV	ReadCOV_NoWrite	0	10551	Discrete	
AI_HIT_Cond_EVD_1.Active	AI_HIT_Cond_EVD_1 (0=Normal 1=Alarm)	Alarm	Normal	602	BV	ReadCOV_NoWrite	0	10552	Discrete	
AI_IncompleteClosing_EVD_1.Active	EVD Incomplete Closing Alarm (0=Normal 1=Alarm)	Alarm	Normal	603	BV	ReadCOV_NoWrite	0	10553	Discrete	
AI_LOP_A_EVD_1.Active	EVD Low Operating Pressure Alarm - Valve 1 (0=Normal 1=Alarm)	Alarm	Normal	604	BV	ReadCOV_NoWrite	0	10554	Discrete	
AI_Low_SH_A_EVD_1.Active	EVD Low SuperHeat Alarm - Valve 1 (0=Normal 1=Alarm)	Alarm	Normal	606	BV	ReadCOV_NoWrite	0	10556	Discrete	
AI_LowDeltaP_COMP_1.Active	Compressor Envelope - Low Pressure Delta Alarm (0=Normal 1=Alarm)	Alarm	Normal	608	BV	ReadCOV_NoWrite	0	10558	Discrete	
AI_LowRatioP_COMP_1.Active	Compressor Envelope - Low Pressure Ratio Alarm (0=Normal 1=Alarm)	Alarm	Normal	609	BV	ReadCOV_NoWrite	0	10559	Discrete	
AI_LowSuct_A_EVD_1.Active	Low Suction Refrigerant Temperature - Valve 1 (0=Normal 1=Alarm)	Alarm	Normal	610	BV	ReadCOV_NoWrite	0	10560	Discrete	
AI_MOP_A_EVD_1.Active	EVD Max Operating Pressure Alarm - Valve 1 (0=Normal 1=Alarm)	Alarm	Normal	612	BV	ReadCOV_NoWrite	0	10562	Discrete	
AI_S1_EVD_1.Active	EVD-S1 Suction Pressure Sensor Alarm (0=Normal 1=Alarm)	Alarm	Normal	614	BV	ReadCOV_NoWrite	0	10564	Discrete	
AI_S2_EVD_1.Active	EVD-S2 Suction Temperature Sensor Alarm (0=Normal 1=Alarm)	Alarm	Normal	615	BV	ReadCOV_NoWrite	0	10565	Discrete	
AI_S4_EVD_1.Active	EVD-S4 Discharge Temperature Sensor Alarm (0=Normal 1=Alarm)	Alarm	Normal	617	BV	ReadCOV_NoWrite	0	10567	Discrete	
AI_SuctHiP_COMP_1.Active	Compressor Envelope - SuctHiP_COMP (0=Normal 1=Alarm)	Alarm	Normal	618	BV	ReadCOV_NoWrite	0	10568	Discrete	
AI_SuctLowP_COMP_1.Active	Compressor Envelope - SuctLowP_COMP (0=Normal 1=Alarm)	Alarm	Normal	619	BV	ReadCOV_NoWrite	0	10569	Discrete	
HP_Defrost_Active.Active	Heat Pump Defrost Alarm	Alarm	Normal	631	BV	ReadCOV_NoWrite		10579	Discrete	
Comp_Staging_Order_Skipped.Active	Compressor Staging Order is Skipped Warning (0=Normal 1=Alarm)	Alarm	Normal	632	BV	ReadCOV_NoWrite	0	10580	Discrete	
Heat_Pump_Heating_Lock_Out_Alarm.Active	Heat Pump Heating Locked Out Alarm	Alarm	Normal	633	BV	ReadCOV_NoWrite		10581	Discrete	
EVD_PrePosition_Alarm_1.Active	Unexpected EEV Position (0=Normal 1=Alarm)	Alarm	Normal	634	BV	ReadCOV_NoWrite	0	10582	Discrete	
ER_Wheel_High_DP.Active	Energy Recovery Wheel high differential pressure (0=Normal 1=Alarm)	Alarm	Normal	731	BV	ReadCOV_NoWrite	0	10679	Discrete	
OAD_Feedback_Error_Not_Economizing.Active	Feedback indicates OAD is not opening during economizer	Alarm	Normal	741	BV	ReadCOV_NoWrite		10690	Discrete	
OAD_Feedback_Error_Economizing.Active	Feedback indicates OAD is open	Alarm	Normal	742	BV	ReadCOV_NoWrite		10692	Discrete	
OAD_Feedback_Error_OAD_Not_Modulating.Active	Feedback indicates the OAD is not modulating	Alarm	Normal	743	BV	ReadCOV_NoWrite		10694	Discrete	
OAD_Feedback_Error_Excess_OA.Active	Feedback indicates the OAD is not closing	Alarm	Normal	744	BV	ReadCOV_NoWrite		10696	Discrete	

## Appendix E: Points List

VARIABLE	DESCRIPTION	ACTIVE TEXT	INACTIVE TEXT	BACNET				MODBUS		
				OBJECT INSTANCE	OBJECT TYPE	ACCESS	HYST	INDEX	REGISTER TYPE	SIZE
<b>Binary Values - Commandable</b>										
Aux_BMS_Digital_Output_1	BMS Commanded auxiliary digital output	Active	Inactive	207	BV	ReadCOV_Commandable	0	24	Coil	
Aux_BMS_Digital_Output_2	BMS Commanded auxiliary digital output	Active	Inactive	208	BV	ReadCOV_Commandable	0	25	Coil	
Aux_BMS_Digital_Output_3	BMS Commanded auxiliary digital output	Active	Inactive	209	BV	ReadCOV_Commandable	0	26	Coil	
Aux_BMS_Digital_Output_4	BMS Commanded auxiliary digital output	Active	Inactive	210	BV	ReadCOV_Commandable	0	27	Coil	
Aux_BMS_Digital_Output_5	BMS Commanded auxiliary digital output	Active	Inactive	211	BV	ReadCOV_Commandable	0	28	Coil	
Aux_BMS_Digital_Output_6	BMS Commanded auxiliary digital output	Active	Inactive	212	BV	ReadCOV_Commandable	0	29	Coil	
<b>Integer Values - Read Only</b>										
Allow_Fan_Delay_Remaining	Startup Sequence Fan Damper Delay. Time before enabling Fan startup sequence.			1	IV	ReadCOV_NoWrite	1	30182	Input	1
Supply_Fan_Delay_Remaining	Supply Fan startup sequence. Time before starting supply fan.			2	IV	ReadCOV_NoWrite	1	30184	Input	1
Exhaust_Fan_Delay_Remaining	Exhaust Fan startup sequence. Time before starting exhaust fan.			3	IV	ReadCOV_NoWrite	1	30186	Input	1
LatestAlm	Most recent alarm. See alarm table.			7	IV	ReadCOV_NoWrite	1	30195	Input	2
<b>Integer Value - Read Only</b>										
Active_Temperture_Reset_Mode	Temperature Reset Type (1=No Reset, Supply Control 2=Space 3=Return 4=outside)			9	IV	ReadCOV_NoWrite	0	656	Input Register	1
<b>Integer Value - Read/Write Commandable</b>										
Temperature_Reset_Mode	Temperature Reset Type (1=No Reset, Supply Control 2=Space 3=Return 4=outside)			8	IV	ReadCOV_Commandable	0	106	Holding Register	1
<b>Large Board Points</b>										
<b>Binary Values - Read Only</b>										
High_Low_Press_Circ_A_Alarm.Active	High Low Pressure Switch Alarm Circuit A	Alarm	Normal	733	BV	ReadCOV_NoWrite	0	10682	Discrete	
High_Low_Press_Circ_B_Alarm.Active	High Low Pressure Switch Alarm Circuit B	Alarm	Normal	734	BV	ReadCOV_NoWrite	0	10683	Discrete	
High_Low_Press_Circ_C_Alarm.Active	High Low Pressure Switch Alarm Circuit A	Alarm	Normal	735	BV	ReadCOV_NoWrite	0	10684	Discrete	
High_Low_Press_Circ_D_Alarm.Active	High Low Pressure Switch Alarm Circuit B	Alarm	Normal	736	BV	ReadCOV_NoWrite	0	10685	Discrete	
High_Low_Press_Circ_C_Alarm.Active	High Low Pressure Switch Alarm Circuit C	Alarm	Normal	735	BV	ReadCOV_NoWrite	0	10684	Discrete	
High_Low_Press_Circ_D_Alarm.Active	High Low Pressure Switch Alarm Circuit D	Alarm	Normal	736	BV	ReadCOV_NoWrite	0	10685	Discrete	
Greentrol_1_Alarm.Active	Greentrol Device Alarm	Alarm	Normal	737	BV	ReadCOV_NoWrite	0	10686	Discrete	
Greentrol_2_Alarm.Active	Greentrol Device Alarm	Alarm	Normal	738	BV	ReadCOV_NoWrite	0	10687	Discrete	
Greentrol_3_Alarm.Active	Greentrol Device Alarm	Alarm	Normal	739	BV	ReadCOV_NoWrite	0	10688	Discrete	

## Appendix E: Points List

VARIABLE	DESCRIPTION	ACTIVE TEXT	INACTIVE TEXT	BACNET				MODBUS		
				OBJECT INSTANCE	OBJECT TYPE	ACCESS	HYST	INDEX	REGISTER TYPE	SIZE
<b>Binary Inputs - Read Only</b>										
Mixed_Temp_Analog_Input	Mixed Temperature			35	AI	ReadCOV_NoWrite	0.1	30263	Input	2
Exhaust_Fan_Speed_Analog_Input	Exhaust Fan Speed Remote Command Analog Input value			143	AI	ReadCOV_NoWrite	1	30455	Input	2
Supply_Fan_Speed_Analog_Input	Supply Fan Speed Remote Command Analog Input value			155	AI	ReadCOV_NoWrite	1	30461	Input	2
<b>Binary Inputs - Read Only</b>										
EAD_End_Switch_Digital_Input	Exhaust Air Damper End Switch Digital Input Status	Active	Inactive	22	BI	ReadCOV_NoWrite	0	10071	Discrete	
OAD_End_Switch_Digital_Input	OAD End Switch Digital Input Status	Active	Inactive	52	BI	ReadCOV_NoWrite	0	10101	Discrete	
<b>Binary Values - Read Only</b>										
Condenser_Fan_5_Digital_Output	Condenser Fan 5 Digital Output	Active	Inactive	123	BV	ReadCOV_NoWrite	0	10176	Discrete	
Condenser_Fan_6_Digital_Output	Condenser Fan 6 Digital Output	Active	Inactive	124	BV	ReadCOV_NoWrite	0	10177	Discrete	
Condenser_Fan_7_Digital_Output	Condenser Fan 7 Digital Output	Active	Inactive	125	BV	ReadCOV_NoWrite	0	10178	Discrete	
Damper_End_Switch_Alarm.Active	Damper End Switch Alarm (0=Normal 1=Alarm)	Alarm	Normal	420	BV	ReadCOV_NoWrite	0	10371	Discrete	
Exhaust_Fan_1_AMD_analog_input_Alarm.Active	Exhaust Fan 1 CFM Analog Input Alarm (0=Normal 1=Alarm)	Alarm	Normal	424	BV	ReadCOV_NoWrite	0	10374	Discrete	
Freeze_Stat_Alarm.Active	Freeze Stat Alarm (0=Normal 1=Alarm)	Alarm	Normal	441	BV	ReadCOV_NoWrite	0	10391	Discrete	
Mixed_Temperature_Sensor_Alarm.Active	Mixed Temperature Sensor Alarm (0=Normal 1=Alarm)	Alarm	Normal	502	BV	ReadCOV_NoWrite	0	10452	Discrete	
OAD_AMD_analog_input_Alarm.Active	OAD CFM Analog Input Alarm (0=Normal 1=Alarm)	Alarm	Normal	506	BV	ReadCOV_NoWrite	0	10456	Discrete	
<b>Integer Value - Read Only</b>										
Active_Temperature_Reset_Mode	Temperature Reset Type (1=No Alarm, Supply Control 2=Space 3=Return 4=outside)			9	IV	ReadCOV_NoWrite	0	656	Input Register	1
<b>Integer Value - Read/Write Commandable</b>										
Temperature_Reset_Mode	Temperature Reset Type (1=No Alarm, Supply Control 2=Space 3=Return 4=outside)			8	IV	ReadCOV_Commandable	0	106	Holding Register	1



FACTORY MODBUS CONNECTIONS

COMPONENTS MOUNTED AND WIRED BY FACTORY

MAIN UNIT CONTROL CENTER

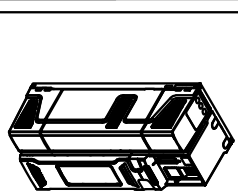
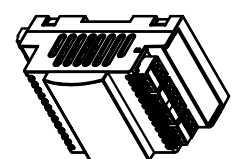
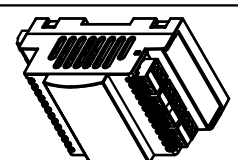
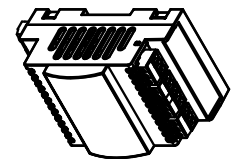
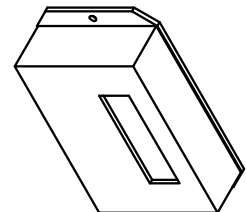
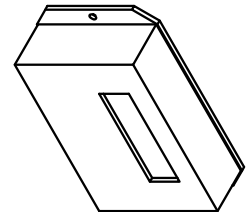
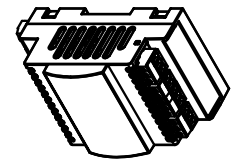
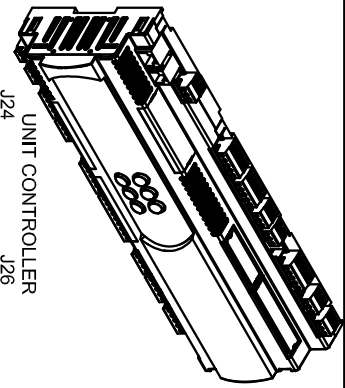

FURNACE CONTROL CENTER

REFRIGERATION SERVICE COMPARTMENT

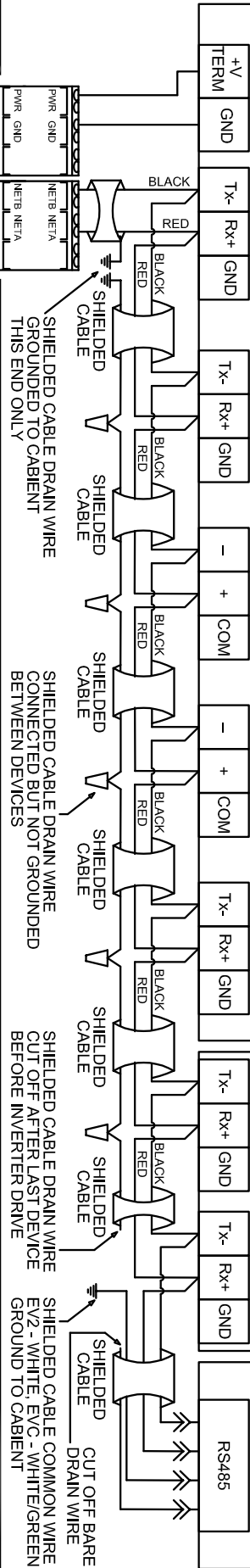

COMPONENTS FIELD MOUNTED AND WIRED IN ROOM/SPACE

FIELD WIRING - - - - -  
FACTORY WIRING - - - - -

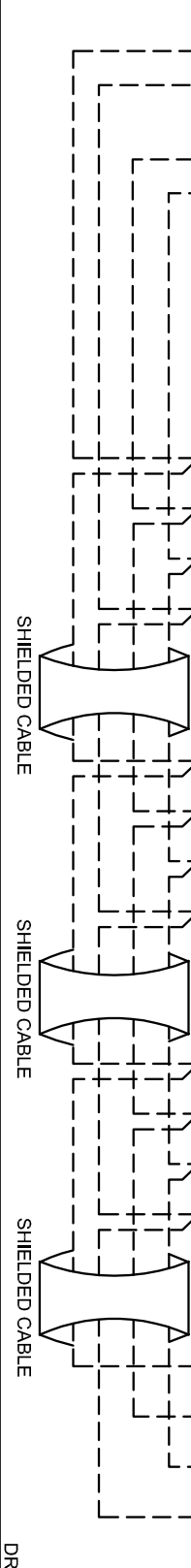
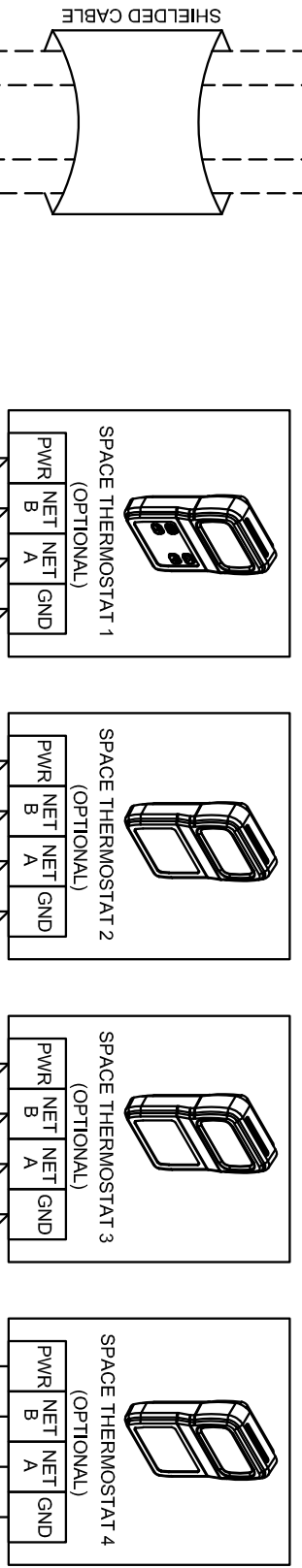

DRWG:2948063-02

## Appendix G: Fault Detection and Diagnostics

The Fault Detection and Diagnostics (FDD) will send a feedback signal from the outdoor air (OA) damper to the controller on the OA damper user interface. This allows the controller to determine if the economizer is operating correctly. Various faults and statuses will display on the controller and through the Building Management System as per the Title 24 Economizer Fault Detection and Diagnostic requirements.

### Enable Fault Detection and Diagnostics

When ordered, the FDD will come enabled from the factory. The FDD alarms can be disabled through the service config menu in the controller. To access the service config menu, navigate the following way: 'Ctrl variables' → 'Advanced' → 'Unit Config' → 'Service Config'. Alarm tolerance and read frequency will also be able to be adjusted through this menu.

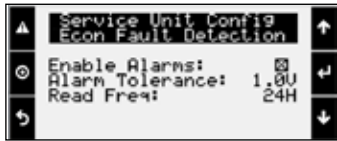

There will be an 'Actuator Feedback' screen in the 'Service Info' menu that will show the commanded damper position, the actual feedback position, and when the damper positions were last read. This screen is also where the field could force the FDD to read the damper position via a check box option. The service info menu can be accessed via the following: 'Ctrl → variables' → 'Advanced' → 'Service Info'.

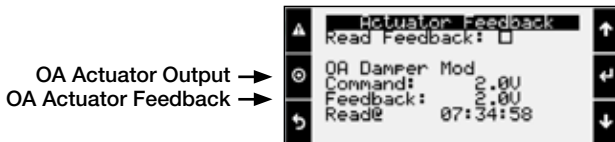

**Faults/Alarms** - Additional faults can generate when the Economizer FDD is enabled, below is a list of the alarms and a description of each. These alarms can also be generated through a BACnet® protocol only.

- **Not Economizing when it should** will generate when FDD is enabled, the outdoor damper status is active on economizer, and the feedback signal from the OA damper is below the damper commanded position by more than 1VDC. Because of the speed of the actuator there is a 3-minute alarm delay to allow the actuator a chance to "catch up" if a sudden change in damper position happens.



- **Economizing when it should not** will generate when FDD is enabled, the outdoor damper status is NOT active on economizer, and the feedback signal from the OA damper is above the damper commanded position by more than 1VDC. Because of the speed of the actuator there is a 3-minute alarm delay to allow the actuator a chance to "catch up" if a sudden change in damper position happens.



- **Damper not modulating** will show up when FDD is enabled, Damper status is NOT Active on Economizer, and feedback signal is not within 1VDC above or below the damper commanded position within 180 seconds.

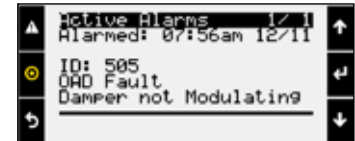

- **Excess outdoor air** will generate when FDD is enabled, the outdoor damper status is active on economizer, and the feedback signal from the OA damper is above the damper commanded position by more than 1VDC. Because of the speed of the actuator there is a 3-minute alarm delay to allow the actuator a chance to "catch up" if a sudden change in damper position happens.



## Appendix G: Fault Detection and Diagnostics

Below is the BACnet Point if the Fault Detection and Diagnostic Alarms are to be read through BACnet:

<b>Points List • BACnet®</b>			
<b>Type</b>	<b>Instance</b>	<b>Name</b>	<b>Read Write</b>
Binary	741	OAD_Feedback_Error_Not_Economizing.Active	ReadCOV_NoWrite
Binary	742	OAD_Feedback_Error_Economizing.Active	ReadCOV_NoWrite
Binary	743	OAD_Feedback_Error_OAD_Not_Modulating.Active	ReadCOV_NoWrite
Binary	744	OAD_Feedback_Error_Excess_OA.Active	ReadCOV_NoWrite

## Our Commitment

---

*As a result of our commitment to continuous improvement, Accurex reserves the right to change specifications without notice.*

Product warranties can be found online at [accurex.com](http://accurex.com), either on the specific product page or in the Warranty section of the website at [Accurex.com/Resources/Warranty](http://Accurex.com/Resources/Warranty).



P.O. Box 410 Schofield, WI 54476  
Phone: 800.333.1400 • Fax: 715.241.6191  
Parts: 800.355.5354 • [accurex.com](http://accurex.com)