

## Installation, Operation and Maintenance Manual

Please read and save these instructions for future reference. Read carefully before attempting to assemble, install, operate or maintain the product described. Protect yourself and others by observing all safety information. Failure to comply with instructions could result in personal injury and/or property damage!



### General Safety Information

#### DANGER

Always disconnect power before working on or near a unit. Lock and tag the disconnect switch or breaker to prevent accidental power up.

#### CAUTION

When servicing the unit, motor may be hot enough to cause pain or injury. Allow motor to cool before servicing.

#### IMPORTANT

All factory provided lifting lugs must be used when lifting any unit. Failure to comply with this safety precaution could result in property damage, serious injury or death.

#### WARNING

Disconnect all electrical power to the fan and secure to the "OFF" position prior to inspection or servicing. Failure to comply with this safety precaution could result in serious injury or death.

#### WARNING

Improper installation, adjustment, alteration, service or maintenance can cause property damage, injury or death. Read the installation, operating and maintenance instructions thoroughly before installing or servicing this equipment.

#### FOR YOUR SAFETY

This appliance is not intended for use by persons (including children) with reduced physical, sensory or mental capabilities, or lack of experience and knowledge, unless they have been given supervision or instruction concerning use of the appliance by a person responsible for their safety. Children should be supervised to ensure that they do not play with the appliance.

#### FOR YOUR SAFETY

MAXIMUM ALTITUDE: 11154 FT OR 3400 M

## General Safety Information

---

Only qualified personnel should install this unit. Personnel should have a clear understanding of these instructions and should be aware of general safety precautions. Improper installation can result in electric shock, possible injury due to coming in contact with moving parts, as well as other potential hazards. Other considerations may be required if high winds or seismic activity are present. If more information is needed, contact a licensed professional engineer before moving forward.

1. Follow all local electrical and safety codes, as well as the National Electrical Code (NEC), the National Fire Protection Agency (NFPA), where applicable. Follow the Canadian Electrical Code (CEC) in Canada.
2. The rotation of the supply fan wheel is critical. It must be free to rotate without striking or rubbing any stationary objects.
3. Motor must be securely and adequately grounded.
4. Do not spin fan wheel faster than the maximum cataloged fan rpm. Adjustments to fan speed significantly affects motor load. If the fan RPM is changed, the motor current should be checked to make sure it is not exceeding the motor nameplate amps.
5. Do not allow the power cable to kink or come in contact with oil, grease, hot surfaces, or chemicals. Replace cord immediately if damaged.
6. Verify that the power source is compatible with the equipment.
7. Never open fan access doors while the fan is running.



# Table of Contents

## General

Receiving . . . . .	4
Handling . . . . .	4
Unpacking . . . . .	4
Storage	
Indoor . . . . .	4
Outdoor . . . . .	4
Inspection and Maintenance . . . . .	4
Removing from Storage . . . . .	4
Model Number Code . . . . .	5
Listings . . . . .	5
Additional IOMs for Reference . . . . .	5

## Installation

Required Clearances	
Clearance to Combustibles . . . . .	6
Service Clearances . . . . .	6
Duct Sizes . . . . .	7
Indoor Unit Mounting	
Hanging . . . . .	8
Floor Mounted . . . . .	8
Venting Connection Location-Forward Curved . . . . .	9
Venting Connection Location-Mixed Flow . . . . .	10
Outdoor Unit Mounting	
Standard Curb . . . . .	11
Combination Curb . . . . .	12-13
Slab Mounted . . . . .	14
Rail Mounted . . . . .	14
Optional Component Mounting	
Evaporative Cooling Module . . . . .	15
Diffuser . . . . .	15
Line Voltage Electrical Wiring . . . . .	16
Optional Electrical Accessory Wiring	
Evaporative Cooling Module . . . . .	17
Cooling Relay(s) . . . . .	17
Carbon Dioxide (CO <sub>2</sub> ) Sensor . . . . .	17
Fire Suppression System . . . . .	17
Fire Stat Type III . . . . .	17
Duct Smoke Detector . . . . .	17
Remote Panel . . . . .	18
Room Temperature Sensing Devices . . . . .	18
Piping	
Gas . . . . .	19
Optional Evaporative Cooling Module . . . . .	20-21
Optional Split Direct Expansion Coil . . . . .	22
Optional Chilled Water Coil . . . . .	23
Optional Components	
Building Pressure Control . . . . .	24
Building Static Pressure Sensor (w/microprocessor) . . . . .	24
Duct Pressure Control . . . . .	24
Carbon Dioxide (CO <sub>2</sub> ) Sensor . . . . .	24
Duct-Mounted Smoke Detector . . . . .	24

## Supply Fan

Fan Identification . . . . .	25
Pre-Start Checks . . . . .	26
Start-Up . . . . .	27

## Start-Up: Indirect Gas-Fired Heating

Optional Features	
Variable Air Volume . . . . .	28
Recirculation Operation . . . . .	29

## Start-Up: Optional Features

Evaporative Cooling Module . . . . .	30
Other	
Building Freeze Protection . . . . .	31
Microprocessor Controls . . . . .	31
PDX Cooling Module . . . . .	31
Dirty Filter Switch . . . . .	31
Heating/Cooling Inlet Air Sensor . . . . .	31
Inlet/Outlet Damper End Switch . . . . .	31

## Sequence of Operation

Optional Exhaust . . . . .	32
Supply Fan . . . . .	32
Heating . . . . .	32
Optional Cooling . . . . .	32
Optional Variable Volume . . . . .	33
Optional Recirculation . . . . .	33
Optional Night Setback . . . . .	34

## Maintenance

### General

V-Belt Drive . . . . .	35
Snow Accumulation . . . . .	35
Supply Wheels . . . . .	35
Bearings . . . . .	35
Motors . . . . .	36
Filters . . . . .	36
Chilled Water Coils . . . . .	36
Evaporative Cooling Module . . . . .	36
Cooling Coils . . . . .	36

### Seasonal: Heating/Cooling

Start-Up . . . . .	37
Gas Train . . . . .	37
Evaporative Cooling Module . . . . .	37
Winterizing Chilled Water Coils . . . . .	37
Combustion Blower Motor . . . . .	37
Burners and Orifices . . . . .	38
Heat Exchanger . . . . .	38
Flue Collector Box . . . . .	38
Electrical Wiring . . . . .	38
Gas Train . . . . .	38
Replacement Parts . . . . .	38

## Troubleshooting

Supply Fan . . . . .	39-40
Furnace . . . . .	41
Evaporative Cooling . . . . .	42-44

## Reference

Typical Control Center Layout . . . . .	45
Start-Up Checklist . . . . .	46
Maintenance Log . . . . .	47

## Our Commitment . . . . . Backcover



## General

### Receiving

This product may have been subject to road salt during transit. If so, immediately wash off all visible white residue from all exterior surfaces. Upon receiving the product, check to ensure all items are accounted for by referencing the delivery receipt or packing list. Inspect each crate or carton for shipping damage before accepting delivery. Alert the carrier if any damage is detected, **do not refuse shipment**. The customer shall make notation of damage (or shortage of items) on the delivery receipt and all copies of the bill of lading should be countersigned by the delivering carrier. If damaged, immediately contact your manufacturer's representative. Any physical damage to the unit after acceptance is not the responsibility of the manufacturer.

### Handling

Units are to be rigged and moved by the lifting brackets provided or by the skid when a forklift is used. Location of brackets varies by model and size. Handle in such a manner as to keep from scratching or chipping the coating. Damaged finish may reduce ability of unit to resist corrosion.

### Unpacking

Verify that all required parts and the correct quantity of each item have been received. Inspect interior of unit cabinet for any shipped loose items. If any items are missing, report shortages to your local representative to arrange for obtaining missing parts. Sometimes it is not possible that all items for the unit be shipped together due to availability of transportation and truck space. Confirmation of shipment(s) must be limited to only items on the bill of lading.

### Storage

Units are protected against damage during shipment. If the unit cannot be installed and operated immediately, precautions need to be taken to prevent deterioration of the unit during storage. The user assumes responsibility of the unit and accessories while in storage. The manufacturer will not be responsible for damage during storage. These suggestions are provided solely as a convenience to the user.

The ideal environment for the storage of units and accessories is indoors, above grade, in a low humidity atmosphere which is sealed to prevent the entry of blowing dust, rain, or snow. Units designed for outdoor applications may be stored outdoors. All accessories must be stored indoors in a clean, dry atmosphere.

### Indoor

Maintain temperatures evenly to prevent condensation. Remove any accumulations of dirt, water, ice, or snow and wipe dry before moving to indoor storage. To avoid condensation, allow cold parts to reach room

temperature. Leave coverings loose to permit air circulation and to allow for periodic inspection.

The unit should be stored at least 3½ in. (89 mm) off the floor. Clearance should be provided to permit air circulation and space for inspection.

### Outdoor

The unit should be placed on a level surface to prevent water from leaking into the unit. The unit should be elevated so that it is above water and snow levels. Ensure sufficient support to prevent unit from settling into soft ground. Locate parts far enough apart to permit air circulation, sunlight, and space for periodic inspection. To minimize water accumulation, place all unit parts on blocking supports so that rain water will run off.

Do not cover parts with plastic film or tarps as these cause condensation of moisture from the air passing through heating and cooling cycles.

### Inspection and Maintenance

While in storage, inspect units once per month. Keep a record of inspection and maintenance performed.

If moisture or dirt accumulations are found on parts, the source should be located and eliminated. At each inspection, rotate the fan wheel by hand ten to fifteen revolutions to distribute lubricant on motor. If paint deterioration begins, consideration should be given to touch-up or repainting. Units with special coatings may require special techniques for touch-up or repair.

Machined parts coated with rust preventive should be restored to good condition promptly if signs of rust occur. Immediately remove the original rust preventive coating with petroleum solvent and clean with lint-free cloths. Polish any remaining rust from surface with crocus cloth or fine emery paper and oil. Do not destroy the continuity of the surfaces. Wipe thoroughly clean with Tectyl® 506 (Ashland Inc.) or the equivalent. For hard to reach internal surfaces or for occasional use, consider using Tectyl® 511M Rust Preventive, WD-40® or the equivalent.

### Removing from Storage

As units are removed from storage to be installed in their final location, they should be protected and maintained in a similar fashion until the equipment goes into operation.

Prior to installing the unit and system components, inspect the unit assembly to make sure it is in working order.

1. Check all fasteners, set screws on the fan, wheel, bearings, drive, motor base, and accessories for tightness.
2. Rotate the fan wheel(s) by hand and assure no parts are rubbing.



# General

## Model Number Code

The model number code provides basic identification of the unit. The serial number can be used by the manufacturer's representative or the factory to identify the specific unit configuration. The serial number of the unit must be provided when consulting the manufacturer's representative or the factory.

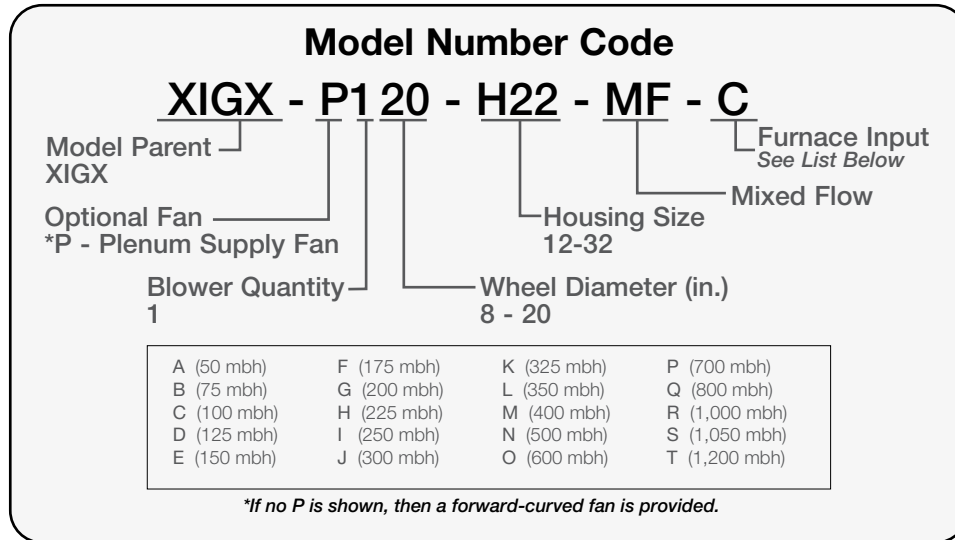

RANGE OF EXTERNAL STATIC PRESSURES: 0.00 - 4.00 IN.W.C. OR 0.000 - 0.995 KPA

### Listings

Units are listed for installation in the United States and Canada.

- Installation of gas-fired duct furnaces must conform with local building codes. In the absence of local codes, installation must conform to the National Fuel Gas code, ANSI Z223.1 or in Canada, CAN/CGA-B149 installation codes.
- All electrical wiring must be in accordance with the regulation of the National Electrical Code, ANSI/NFPA 70.
- Unit is approved for installation downstream from refrigeration units. In these conditions, condensate could form in the duct furnace and provision must be made to dispose of the condensate.

### Additional IOMs for Reference

For complete furnace information reference the Indirect Gas-Fired Heat Modules IOM. Available turndown control options include:

	Electronic Modulation
<b>Single Furnace Unit</b>	4:1- uses modulating valve and furnace controller
	*High turndown uses a 4:1 modulating valve with a proprietary manifold and furnace controller
<b>Two Furnace Unit</b>	8:1- uses one 4:1 modulating furnace with furnace controller and one 2-stage furnace
	4:1 - uses two 4:1 modulating furnaces controlled in parallel
	*High turndown furnaces in a series configuration use one high turndown furnace and one 2-stage furnace
<b>Three Furnace Unit</b>	*High turndown furnaces in a parallel configuration use two high turndown furnaces, controlled in parallel
	12:1 - uses one 4:1 modulating furnace, one 2 stage furnace and one 1-stage furnace
	*High turndown uses one high turndown furnace, one 2-stage furnace, and one 1-stage furnace

*\* High turndown furnace patent pending.*

	Staged
<b>Single Furnace Unit</b>	8 stage



# Installation

## Required Clearances

### Clearance to Combustibles

Clearance to combustibles is defined as the minimum distance required between the unit and adjacent combustible surfaces to ensure the adjacent surface temperature does not exceed 90°F above the ambient temperature.

	Floor	Top	Sides	Ends
Indirect Gas-Fired Units	0	0	0	0

All measurements are shown in inches (cm).

### Service Clearances

Service clearances are factory recommendations for ease of servicing. All deviations must still adhere to clearance to combustibles requirements. All deviations from the service clearance recommendations are at the discretion of the end-user as this may impede component removal.

Reference the *Start-Up: Optional Features, Other, PDX Cooling Module* section in this IOM for further clearance requirements, if applicable.

Not all models listed will incorporate access on both sides; this will vary based on supply fan type and options selected.

Recommended Minimum Service Clearances		
Model	Housing	A inches (cm)
XIGX	H12	42 (1067) on the controls side of the unit
	H22	
	H32	

\* 67 in. (170 cm) when equipped with evaporative cooling module

\*\* 61 in. (155 cm) when equipped with evaporative cooling module over 4800 cfm



# Installation

## Duct Sizes

See charts for duct sizes and straight duct lengths recommended for optimal performance based on AMCA Publication 201-90. Using duct sizes less than recommended will affect fan performance. Follow good duct installation practices for the remaining ductwork.

Housing	Furnace Size (MBH)	Down Discharge		End Discharge	
		H	W	H	W
12	100	25	23	15	31
	150	25	23	21	31
	200	25	23	27	31
	250	25	23	32	31
22	150	26	25	21	31
	200	26	25	27	31
	250	26	25	32	31
	300	26	25	38	31
	350	26	34	39	41.4
	400	26	34	39	41.4
	500	26	25	32	31
600	26	25	38	31	
32	250	26	34	30	41
	300	26	34	30	41
	350	26	34	39	41
	400	26	34	39	41
	500	26	34	30	41
	600	26	34	30	41
	700	26	34	39	41
	800	26	34	39	41
	1050	26	34	39	41
	1200	26	34	39	41

### Hanging

When suspending a unit indoors, adequate structural support is required. Design of the support structure is the responsibility of the installing contractor and/or the structural engineer. Support structure will vary based on application, building design, code requirements, unit size, and unit weight. The following information is provided as a guideline; it is not intended to replace job specific structural design provided by a structural engineer.

#### 1. Install Field-Supplied Hangers

Install hangers from ceiling supports. Ensure hangers are located to avoid interference with access doors and allows for component removal.

#### 2. Install Unit

Using sheet metal screws, assemble optional shipped loose modules. Ensure that all cover seams and vertical panels on each module are fastened securely. Raise the assembled unit into place.

Appropriate field-supplied unit supports, such as C-channel or angle iron, are to be placed under the unit. Fasten the unit supports to the hangers and to the unit using appropriate methods.

To prevent the unit from swinging and to provide a safe environment for service and maintenance, additional measures must be taken to secure the unit in all directions.

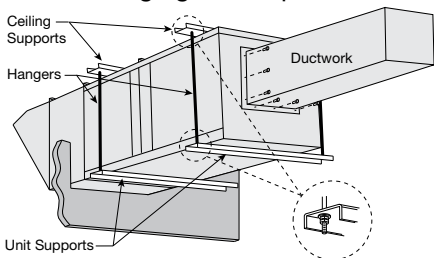

The installer is responsible for determining appropriate support and fastening methods to ensure compliance with all applicable codes.

#### 3. Install Vent Piping

Refer to your unit submittal to determine the correct indoor venting option. Vent piping is supplied by others. Reference the supplemental IOM: *Indirect Gas-Fired Furnace, Model PVF and PVG*.

#### 4. Attach Ductwork

Using appropriate methods, attach ductwork to unit. Follow good duct practices for all ductwork. Install ductwork in accordance with SMACNA and AMCA guidelines, NFPA 96 and any further local codes. Reference *Installation, Duct Sizes* section in this Installation, Operation, and Maintenance Manual for proper duct sizes.

#### 5. Seal Wall Opening

Sealant must be applied around the perimeter of the weatherhood to prevent water penetration and drafts into the building.

### Floor Mounted

#### 1. Install Unit

Use a crane and a set of spreader bars hooked to the factory lifting lugs to lift and locate the unit in place. The use of all lifting lugs and a set of spreader bars is mandatory when lifting the unit.

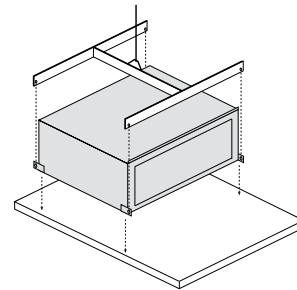

It is recommended that any shipped loose modules be installed after the base unit. The shipped loose modules must be fastened together. Fasten the cover seams and vertical panels on each module using sheet metal screws. Some shipped loose modules will require field-provided shims for proper alignment with the base unit.

Fasten the unit using appropriate methods. The installer is responsible for determining appropriate support and fastening methods to ensure compliance with all applicable codes.

#### 2. Install Vent Piping

Refer to your unit submittal to determine the correct indoor venting option. Vent piping is supplied by others. Reference the supplemental IOM: *Indirect Gas-Fired Furnace, Model PVF and PVG*.

#### 3. Attach Ductwork

Refer to the unit submittal for the duct size and location. An appropriate sealant should be used around the discharge opening of the unit to create a weathertight seal.

Follow good duct practices for all ductwork. Install ductwork in

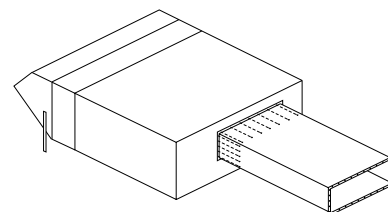

accordance with SMACNA and AMCA guidelines, NFPA 96 and local codes. Reference *Installation, Duct Sizes* section in this Installation, Operation, and Maintenance Manual for proper duct sizes.

#### Note for both Hanging and Floor Mounted Installations:

The manufacturer recommends units equipped with evaporative cooling be installed outdoors. If an evaporative cooling module must be installed indoors, it is recommended a field-supplied secondary drain pan be installed under the evaporative cooling section. This will help mitigate damage to building materials in the event the evaporative cooling module sump tank overflows.





# Installation

## Indoor Unit Mounting

### Venting Connection Location - Forward Curved

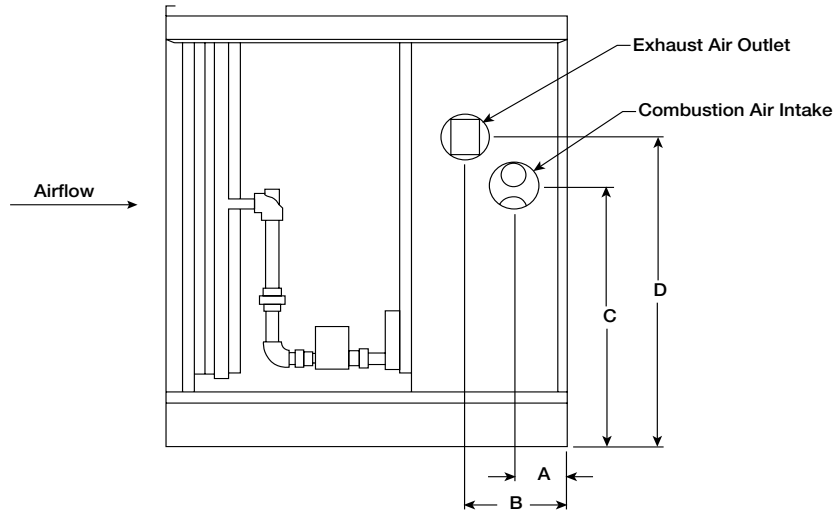

Housing	Furnace Size (MBH)	A	B	C	D	Flue Connection Size, Diameter in inches (cm)		Concentric Kit Connection Size			
						Exhaust	Intake	From Furnace to Kit		Kit to Outdoors	
								Exhaust	Intake	Exhaust	Intake
12	100	4.45 (11.30)	8.45 (21.46)	23.43 (59.51)	27.9 (70.87)	4 (10.16)	4 (10.16)	4 (10.16)	4 (10.16)	4 (10.16)	6 (15.24)
	150	4.45 (11.30)	8.45 (21.46)	23.43 (59.51)	27.9 (70.87)	4 (10.16)	4 (10.16)	4 (10.16)	4 (10.16)	4 (10.16)	6 (15.24)
	200	5.64 (14.32)	9.64 (24.49)	23.97 (60.88)	30.9 (78.49)	6 (15.24)	6 (15.24)	6 (15.24)	6 (15.24)	6 (15.24)	8 (20.32)
	250	5.64 (14.32)	9.64 (24.49)	23.97 (60.88)	30.9 (78.49)	6 (15.24)	6 (15.24)	6 (15.24)	6 (15.24)	6 (15.24)	8 (20.32)
22	150	4.45 (11.30)	8.45 (21.46)	29.38 (74.63)	33.85 (85.98)	4 (10.16)	4 (10.16)	4 (10.16)	4 (10.16)	4 (10.16)	6 (15.24)
	200	5.67 (14.4)	9.67 (24.56)	24.97 (63.42)	31.9 (81.03)	6 (15.24)	6 (15.24)	6 (15.24)	6 (15.24)	6 (15.24)	8 (20.32)
	250	5.67 (14.4)	9.67 (24.56)	24.97 (63.42)	31.9 (81.03)	6 (15.24)	6 (15.24)	6 (15.24)	6 (15.24)	6 (15.24)	8 (20.32)
	300	5.67 (14.4)	9.67 (24.56)	24.97 (63.42)	31.9 (81.03)	6 (15.24)	6 (15.24)	6 (15.24)	6 (15.24)	6 (15.24)	8 (20.32)
	350	5.67 (14.4)	9.67 (24.56)	19.01 (48.29)	25.94 (65.89)	6 (15.24)	6 (15.24)	6 (15.24)	6 (15.24)	6 (15.24)	8 (20.32)
	400	5.67 (14.4)	9.67 (24.56)	19.01 (48.29)	25.94 (65.89)	6 (15.24)	6 (15.24)	6 (15.24)	6 (15.24)	6 (15.24)	8 (20.32)
	500	5.67 (14.4)	9.67 (24.56)	24.97 (63.42)	31.9 (81.03)	6 (15.24)	6 (15.24)	6 (15.24)	6 (15.24)	6 (15.24)	8 (20.32)
	600	5.67 (14.4)	9.67 (24.56)	24.97 (63.42)	31.9 (81.03)	6 (15.24)	6 (15.24)	6 (15.24)	6 (15.24)	6 (15.24)	8 (20.32)
32	250	5.67 (14.4)	9.67 (24.56)	28.32 (71.93)	35.64 (90.53)	6 (15.24)	6 (15.24)	6 (15.24)	6 (15.24)	6 (15.24)	8 (20.32)
	300	5.67 (14.4)	9.67 (24.56)	28.32 (71.93)	35.64 (90.53)	6 (15.24)	6 (15.24)	6 (15.24)	6 (15.24)	6 (15.24)	8 (20.32)
	500	5.96 (15.14)	9.71 (24.66)	28.31 (71.91)	35.27 (89.59)	6 (15.24)	6 (15.24)	6 (15.24)	6 (15.24)	6 (15.24)	8 (20.32)
	500	5.96 (15.14)	9.71 (24.66)	28.31 (71.91)	35.27 (89.59)	6 (15.24)	6 (15.24)	6 (15.24)	6 (15.24)	6 (15.24)	8 (20.32)
	500	5.96 (15.14)	9.71 (24.66)	28.31 (71.91)	35.27 (89.59)	6 (15.24)	6 (15.24)	6 (15.24)	6 (15.24)	6 (15.24)	8 (20.32)
	600	5.96 (15.14)	9.71 (24.66)	28.31 (71.91)	35.27 (89.59)	6 (15.24)	6 (15.24)	6 (15.24)	6 (15.24)	6 (15.24)	8 (20.32)
	1050	5.96 (15.14)	9.71 (24.66)	28.31 (71.91)	35.27 (89.59)	6 (15.24)	6 (15.24)	6 (15.24)	6 (15.24)	6 (15.24)	8 (20.32)
	1050	5.96 (15.14)	9.71 (24.66)	28.31 (71.91)	35.27 (89.59)	6 (15.24)	6 (15.24)	6 (15.24)	6 (15.24)	6 (15.24)	8 (20.32)
	1050	5.96 (15.14)	9.71 (24.66)	28.31 (71.91)	35.27 (89.59)	6 (15.24)	6 (15.24)	6 (15.24)	6 (15.24)	6 (15.24)	8 (20.32)
	1200	5.96 (15.14)	9.71 (24.66)	28.31 (71.91)	35.27 (89.59)	6 (15.24)	6 (15.24)	6 (15.24)	6 (15.24)	6 (15.24)	8 (20.32)

Measurements are shown in inches (cm)



# Installation

## Indoor Unit Mounting

### Venting Connection Location - Mixed Flow

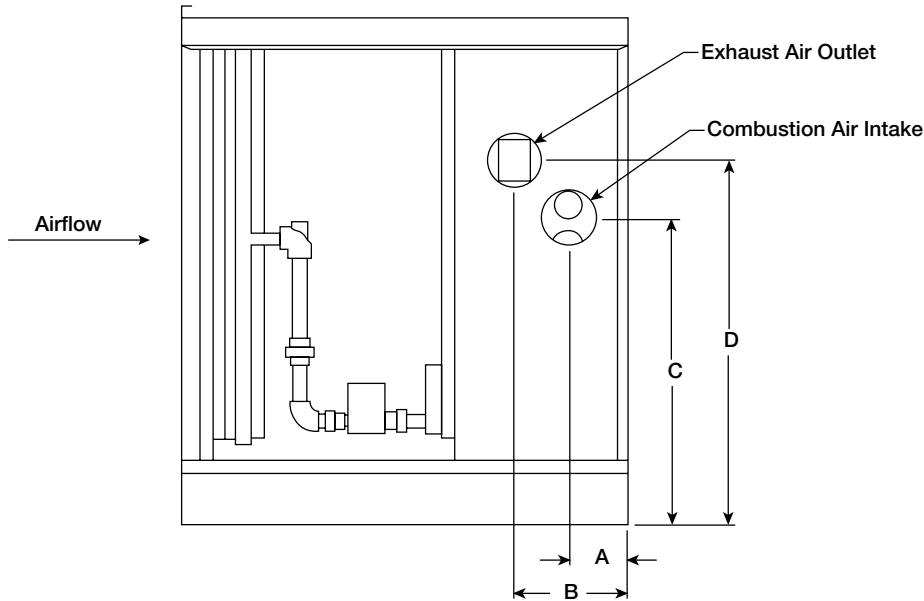

Housing	Furnace Size (MBH)	A	B	C	D	Flue Connection Size (diameter in inches)		Concentric kit Connection Size			
						Exhaust	Intake	From Furnace to Kit		Kit to Outdoors	
								Exhaust	Intake	Exhaust	Intake
12	100	4.45	8.45	14.92	19.39	4	4	4	4	4	6
	150	4.45	8.45	17.93	22.40	4	4	4	4	4	6
	200	5.64	9.64	23.97	30.9	6	6	6	6	6	8
	250	5.64	9.64	23.97	30.9	6	6	6	6	6	8
22	150	4.45	8.45	31.08	25.55	4	4	4	4	4	6
	200	5.67	9.67	20.21	27.14	6	6	6	6	6	8
	250	5.67	9.67	24.97	31.9	6	6	6	6	6	8
	300	5.67	9.67	24.97	31.9	6	6	6	6	6	8
	350	5.67	9.67	19.01	25.94	6	6	6	6	6	8
	400	5.67	9.67	19.01	25.94	6	6	6	6	6	8
	500	5.67	9.67	24.97	31.9	6	6	6	6	6	8
	600	5.67	9.67	24.97	31.9	6	6	6	6	6	8
32	250	5.67	9.67	28.32	35.64	6	6	6	6	6	8
	300	5.67	9.67	28.32	35.64	6	6	6	6	6	8
	500	5.96	9.71	28.31	35.24	6	6	6	6	6	8
	500	5.96	9.71	28.31	35.24	6	6	6	6	6	8
	500	5.96	9.71	28.31	35.24	6	6	6	6	6	8
	600	5.96	9.71	28.31	35.24	6	6	6	6	6	8
	1050	5.96	9.71	28.31	35.24	6	6	6	6	6	8
	1050	5.96	9.71	28.31	35.24	6	6	6	6	6	8
	1050	5.96	9.71	28.31	35.24	6	6	6	6	6	8
	1200	5.96	9.71	28.31	35.24	6	6	6	6	6	8

All measurements are shown in inches.



# Installation

## Outdoor Unit Mounting

### Standard Curb

#### 1. Install Curb and/or Equipment/Leg Support(s)

Position curb and/or equipment/leg support(s) on the roof (reference the unit submittal for placement in relation to the unit). Verify that unit supports are level; shim if necessary. Attach curb to roof and flash into place using appropriate methods. Attach the equipment/leg support(s) to the roof, remove metal cover, flash to wooden nailer, and reinstall cover.

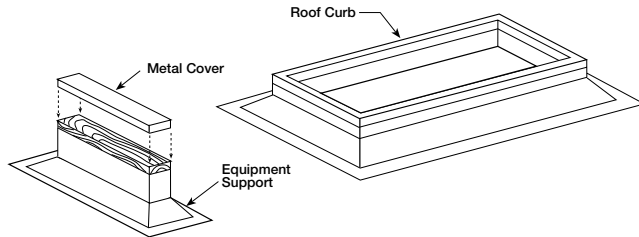

Curb and Equipment Support

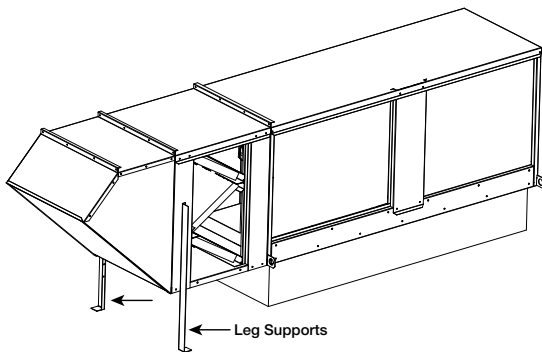

Unit Profile and Leg Support

#### 2. Install Ductwork

Follow good duct practices for all ductwork. Install ductwork in accordance with SMACNA and AMCA guidelines, NFPA 96 and local codes. Reference *Installation, Duct Sizes* section in this Installation, Operation, and Maintenance Manual for proper duct sizes.

The use of a duct adapter is recommended on a downblast (DB) arrangement to align the ductwork with the supply unit. The duct adapter is only a guide and is not to be used as a support for the ductwork.

#### 3. Apply Sealant

Apply an appropriate sealant around the perimeter of the curb and duct to isolate fan vibration and prevent water penetration.

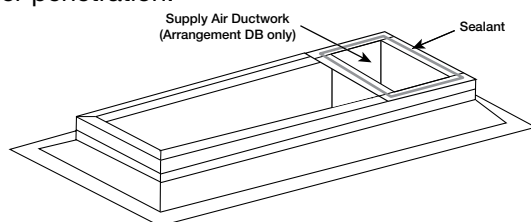

Ductwork

#### 4. Install Unit

Use a crane and a set of spreader bars hooked to the factory lifting lugs to lift and position the unit on the curb/equipment support(s). The use of all lifting lugs and a set of spreader bars is mandatory when lifting the unit. Fasten the unit to the curb/equipment support(s) using appropriate methods. The installer is responsible for determining appropriate support and fastening methods to ensure compliance with all applicable codes.

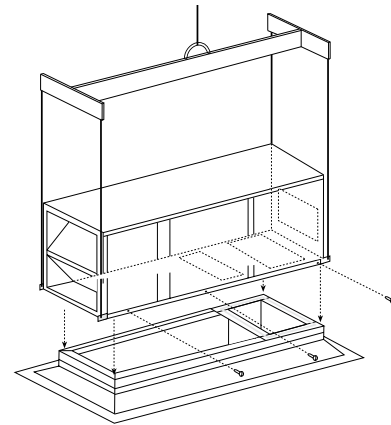

Setting Unit

#### 5. Assemble and Attach Shipped Loose Modules

Using sheet metal screws, assemble optional shipped loose modules. Fasten the cover seams and vertical panels on each module securely.

Some weatherhoods may ship disassembled. Detailed assembly instructions ship with the weatherhood.

If an optional evaporative cooling module is included, reference *Installation, Optional Component Mounting, Evaporative Cooling Module* section in this IOM for more information.

The installer is responsible for ensuring that the unit fastening methods are sufficient to account for the weight and size of these additional modules.

#### 6. Seal Seam(s)

Using an appropriate sealant, seal the seam(s) between each shipped loose module and the weatherhood.

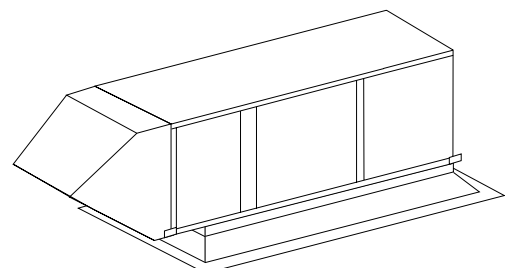

Complete Rooftop Installation

### Combination Curb

#### 1. Install Curb and Equipment/Leg Support(s)

Position curb and equipment/leg support(s) on the roof (reference the unit submittal for placement in relation to the unit). Verify that unit supports are level, shim if necessary. Attach curb to roof and flash into place using appropriate methods. Attach the equipment/leg support(s) to the roof, remove metal cover, flash to wooden nailer and reinstall cover.

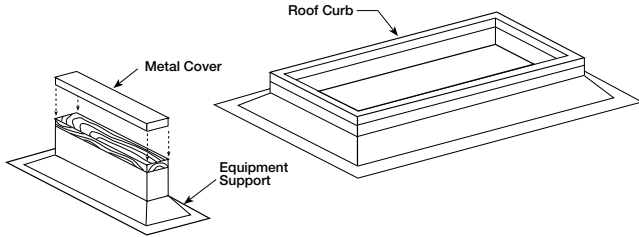

**Curb and Equipment Support**

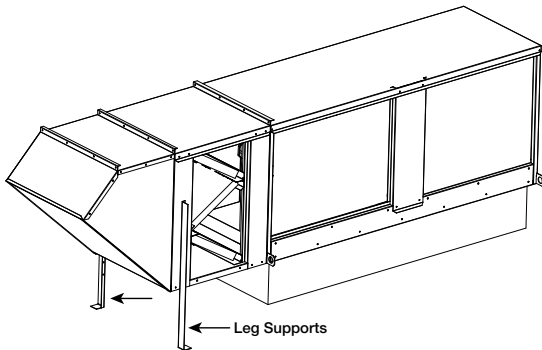

**Unit Profile and Leg Support**

#### 2. Install Combination Curb Adaptor

Install combination curb adaptor over curb, fasten adaptor to curb using appropriate methods. Locate extension so the tall louvered side is over the exhaust opening, as shown in illustration. Caulk vented exhaust extension to combination curb adaptor. Fasten extension to curb adaptor using appropriate methods (field-provided).

The installer is responsible for determining appropriate support and fastening methods to ensure compliance with all applicable codes.

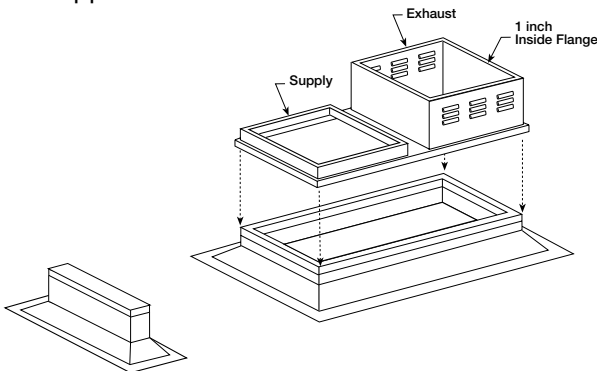

**Combination Extension**

#### 3. Install Ductwork

Follow good duct practices for all ductwork. Install ductwork in accordance with SMACNA and AMCA guidelines, NFPA 96 and local codes. Reference *Installation, Duct Sizes* section in this Installation, Operation, and Maintenance Manual for proper duct sizes.

The use of a duct adapter is recommended on a downblast (DB) arrangement to align the ductwork with the supply unit. The duct adapter is only a guide and is not to be used as a support for the ductwork.

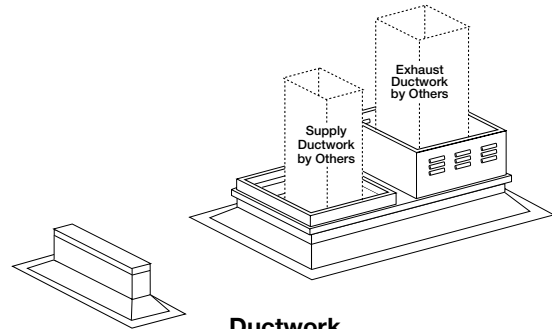

**Ductwork**

#### 4. Apply Sealant

Apply an appropriate sealant around the perimeter of the curb and duct to isolate unit vibration and prevent water penetration.

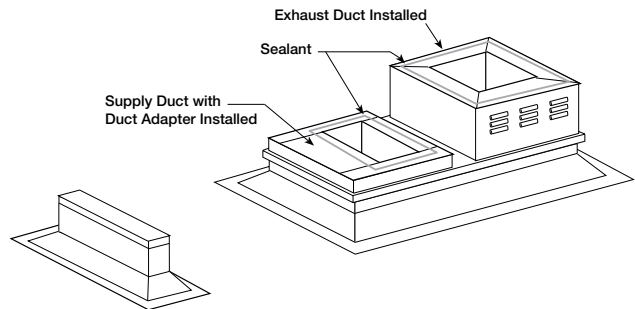

**Sealing Ductwork**



# Installation

## Outdoor Unit Mounting

### Combination Curb (continued)

#### 5. Install Exhaust Fan

Fasten exhaust fan to curb extension using appropriate methods. Installing the exhaust fan prior to the supply unit will allow for easier installation of options. NFPA 96 requires the exhaust fan to be hinged. Follow instructions included with the exhaust fan.

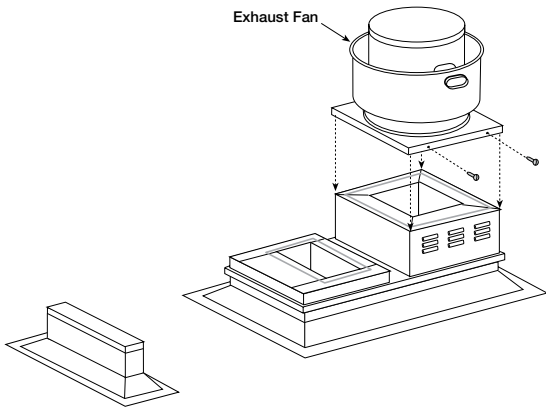

Installing Exhaust Fan

#### 6. Install Exhaust Fan Options

Install hinges (an optional hinge kit is available from manufacturer) with restraining cables and optional grease trap with drain connection.

#### 7. Install Supply Unit

Use a crane and a set of spreader bars hooked to the factory lifting lugs to lift and position the unit on the curb extension and equipment support(s). The use of all lifting lugs and a set of spreader bars is mandatory when lifting unit.

Fasten the unit to the curb extension and equipment support(s) using appropriate methods. The installer is responsible for determining appropriate support and fastening methods to ensure compliance with all applicable codes.

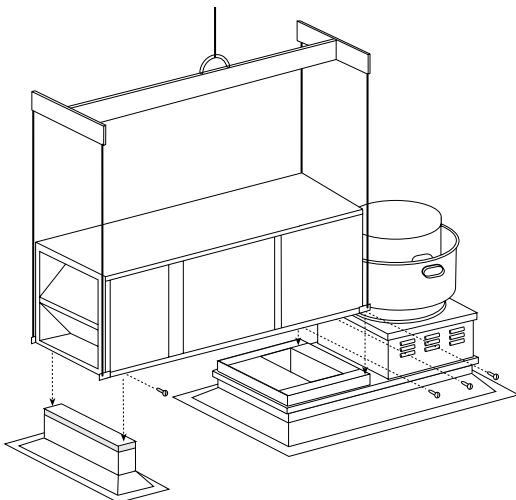

Installing Supply Unit

#### 8. Assemble and Attach Shipped loose Modules

Using sheet metal screws, assemble optional shipped loose modules. Fasten the cover seams and vertical panels on each module securely.

Some weatherhoods may ship disassembled. Detailed assembly instructions ship with the weatherhood.

If an optional evaporative cooling module is included, reference *Installation, Optional Component Mounting, Evaporative Cooling Module* section in this IOM for more information.

The installer is responsible for ensuring that the unit fastening methods are sufficient to account for the weight and size of these additional modules.

#### 9. Seal Seam(s)

Using an appropriate sealant, seal the seam(s) between each shipped loose module and weatherhood.

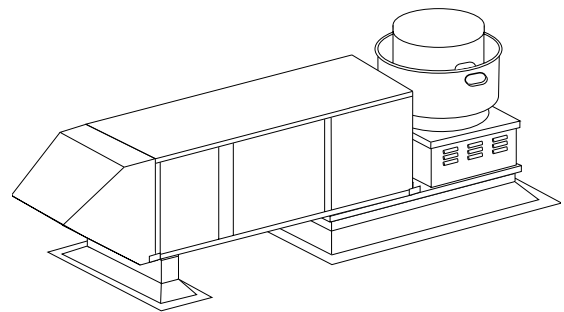

Complete Combination Installation

#### 10. Install Stack (optional)

Clearance may require an exhaust stack. Install an exhaust stack as needed to the exhaust connection on the unit. Install a vent terminator on the exhaust pipe.

Exhaust transition and vent termination must be purchased from the factory for proper operation. Exhaust pipe is by others.

# Installation

## Outdoor Unit Mounting

### Slab

#### 1. Pour Concrete Slab

Pour the concrete slab. Make the slab one foot larger than the unit on all sides. The slab must be capable of supporting the weight of the unit. Proper subgrade preparation must be completed under the slab. Allow the concrete slab to properly cure before installing the unit.

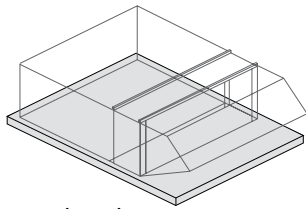

#### 2. Install Unit

Use a crane and a set of spreader bars hooked to the factory lifting lugs to lift and position the unit on the concrete slab. The use of all lifting lugs and a set of spreader bars is mandatory when lifting the unit. It is recommended that any shipped loose modules be installed after the base unit.

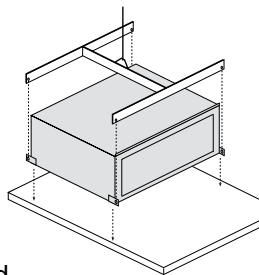

The shipped loose modules must be fastened together. Fasten the cover seams and vertical panels on each module using sheet metal screws. Using an appropriate sealant, seal the seam(s) between each shipped loose module and the weatherhood.

Some shipped loose modules will require field-provided shims for proper alignment with the base unit.

If an optional evaporative cooling module is included, reference *Installation, Optional Component Mounting, Evaporative Cooling Module* section in this IOM for more information.

Fasten the unit to the slab using appropriate methods. The installer is responsible for determining appropriate fastening methods to ensure compliance with all applicable codes.

#### 3. Attach Ductwork

Use an appropriate sealant around the discharge opening of the unit to create a weathertight seal.

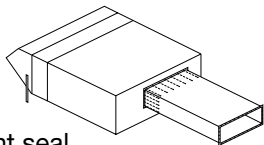

Follow good duct practices for all ductwork. Install ductwork in accordance with SMACNA and AMCA guidelines, NFPA 96 and local codes. Reference *Installation, Duct Sizes* section in this Installation, Operation, and Maintenance Manual for proper duct sizes.

#### 4. Install Stack (optional)

Clearance may require an exhaust stack. Install an exhaust stack as needed to the exhaust connection on the unit. Install a vent terminator on the exhaust pipe.

Exhaust transition and vent termination must be purchased from the factory for proper operation. Exhaust pipe is by others.

### Rail

#### 1. Install Rails

The rails must be located around the perimeter of the base unit on all four sides. This is required to ensure proper unit support.

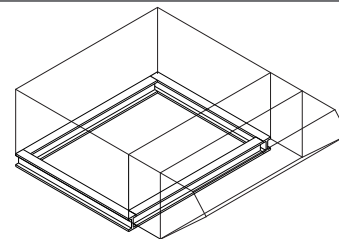

#### 2. Install Unit

Use a crane and a set of spreader bars hooked to the factory lifting lugs to lift and position the unit on the field-supplied rail supports. The use of all lifting lugs and a set of spreader bars is mandatory when lifting the unit. It is recommended that any shipped loose modules be installed after the base unit.

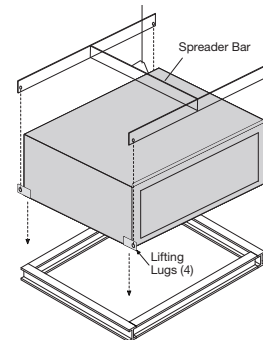

The shipped loose modules must be fastened together. Fasten the cover seams and vertical panels on each module using the appropriate methods. Fasten the unit to the rails using appropriate methods.

If an optional evaporative cooling module is included, reference *Installation, Optional Component Mounting, Evaporative Cooling Module* section in this IOM for more information.

The installer is responsible for determining appropriate fastening methods to ensure compliance with all applicable codes.

#### 3. Attach Ductwork

Use an appropriate sealant around the discharge opening of the unit to create a weathertight seal.

Follow good duct practices for all ductwork. Install ductwork in accordance with SMACNA and AMCA guidelines, NFPA 96 and local codes. Reference *Installation, Duct Sizes* section in this Installation, Operation, and Maintenance Manual for proper duct sizes.

#### 4. Install Stack (optional)

Clearance may require an exhaust stack. Install an exhaust stack as needed to the exhaust connection on the unit. Install a vent terminator on the exhaust pipe.

Exhaust transition and vent termination must be purchased from the factory for proper operation. Exhaust pipe is by others.



# Installation

## Optional Component Mounting

### Evaporative Cooling Module

Note: Small evaporative cooling module will ship attached to the base unit from the factory and will not require any additional fixation to the base unit as illustrated below.

#### 1. Locate Equipment Support(s)

Position equipment support(s) on the roof (reference the unit submittal for placement of equipment support(s) in relation to the unit). Verify that all unit supports are level, shim if necessary. Attach equipment support to the roof using appropriate methods, remove metal cover, flash to wooden nailer and reinstall cover.

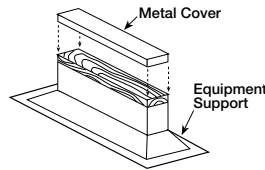

Equipment Support

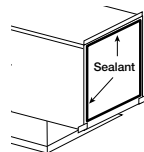

Sealant

#### 2. Apply Sealant

Apply an appropriate sealant around the airstream opening to create an airtight seal.

#### 3. Set Evaporative Cooling Module

Use a crane and a set of spreader bars hooked to the factory lifting lugs to lift and position the module on the equipment support(s). The cover flange on the evaporative cooling module should overlap the cover flange on the unit. The use of all lifting lugs and a set of spreader bars is mandatory when lifting the evaporative cooling module.

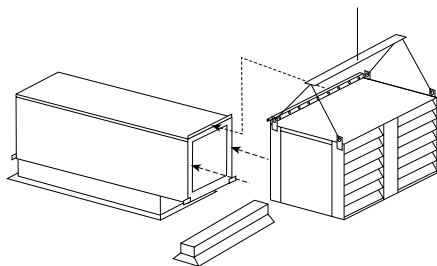

Placing Evaporative Module

#### 4. Secure Cooling Module to Unit

Use self-tapping screws to fasten the cooling module to the base unit along the top and down both sides. Fasten at the top through the cover flanges. To fasten the sides, the media may need to be removed. To remove the media, first remove the access panel on the evaporative module and disconnect the evaporative pump(s). The media will now slide out. With the media removed, you can access the side fastening points inside the evaporative cooling module. With all the screws in place, reinstall the media, reconnect the pumps and reinstall the access panel.

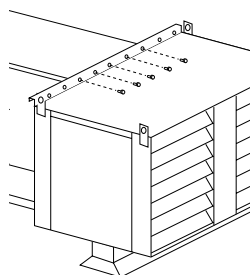

Securing Evaporative Module

The evaporative cooling module must be mounted level to ensure proper operation and water drainage.

### Diffuser

The location of the discharge diffuser is critical for optimum performance of the system.

Using self-tapping screws, attach diffuser to the ductwork or unit. Be sure to maintain the recommended floor to diffuser height. Refer to the chart for this information.

Airflow cfm (m <sup>3</sup> /s)	Diffuser Height feet (m)		
	Minimum	Recommended	Maximum
4,000 (2)	15 (5)	20 (6)	25 (8)
6,000 (3)	15 (5)	20 (6)	25 (8)
8,000 (4)	20 (6)	20-25 (6 - 8)	30 (9)
10,000 (5)	20 (6)	20-25 (6 - 8)	35 (11)
13,000 or greater (6 or greater)	25 (8)	30-35 (9 - 11)	40 (12)

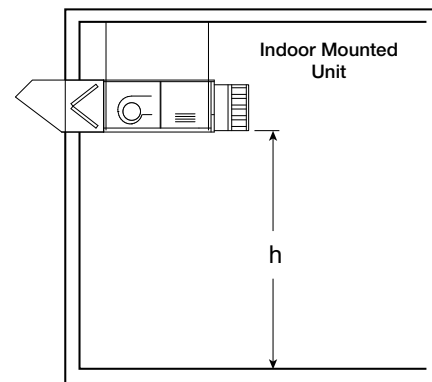

Thru-Wall Diffuser Height

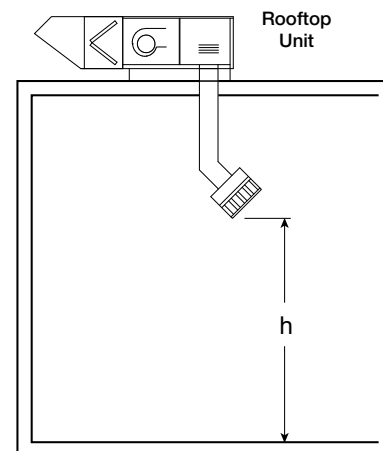

Rooftop Diffuser Height

# Installation

## Line Voltage Electrical Wiring

Before connecting power to the unit, read and understand the following instructions and wiring diagrams. Complete wiring diagrams are attached on the inside of the control center door(s).

All wiring must be done in accordance with the latest edition of the National Electrical Code NFPA 70 and any local codes that may apply. In Canada, wiring must be done in accordance with the Canadian Electrical Code.

The equipment must be properly grounded. Any wiring running through the unit in the airstream must be protected by metal conduit, metal clad cable or raceways.

### CAUTION

If replacement wire is required, it must have a temperature rating of at least 105°C.

Any wiring deviations may result in personal injury or property damage. Manufacturer is not responsible for any damage to, or failure of the unit caused by incorrect field wiring.

### DANGER

High voltage electrical input is needed for this equipment. This work should be performed by a qualified electrician.

### 1. Determine the Size of the Main Power Lines

The unit's nameplate states the voltage and the unit's MCA. The main power lines to the unit must be sized accordingly. The nameplate is located on the outside of the unit on the control panel side.

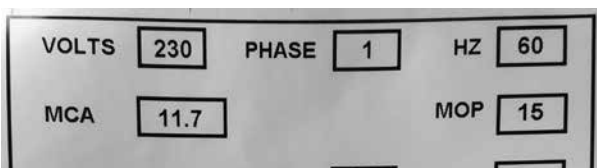

Electrical Nameplate

### 2. Provide the Opening(s) for the Electrical Connections

Electrical openings vary by unit size and arrangement and are field-supplied.

### 3. Connect the Main Power

Connect the main power lines to the disconnect switch and main grounding lug(s). Torque connections to disconnect according manufacturer specifications.

### 4. Wire the Optional Convenience Outlet

The convenience outlet requires a separate 115V power supply circuit. The circuit must include short circuit protection supplied by others.

### 5. Wire Evaporative Cooling Pumps

Reference the unit wiring diagram attached to the inside of the unit control center door. Locate the "Evap Pump(s)" on the wiring diagram. If they are connected with solid lines indicating factory wiring, no field wiring is required.

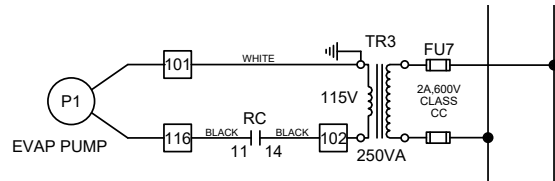

Evap Pump Factory Wiring Example

Refer to wiring diagram for unit specific wiring

If the evaporative pump(s) are shown with dashed lines indicating field wiring, wire the pumps to the terminals indicated in the unit control center.

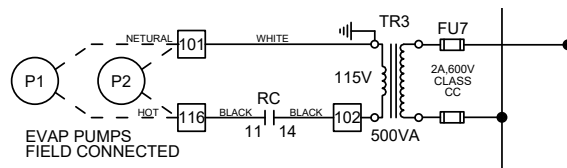

Evap Pump Field Wiring Example

Refer to wiring diagram for unit specific wiring

Larger units may require a separate 115 VAC power source. If this is necessary, it will be indicated on the wiring diagram. Wire a separate 115 VAC power supply as indicated on the wiring diagram to power the pumps.

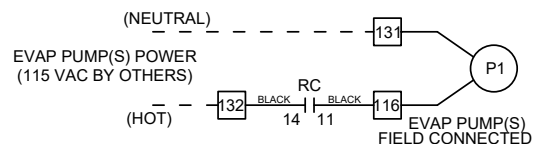

Separate Power Wiring Example

Refer to wiring diagram for unit specific wiring





## Optional Electrical Accessory Wiring

### Evaporative Cooling Module

#### 1. Auto Drain and Fill Valves

The unit may have been provided with the auto drain and fill option. If this option has been provided, the unit wiring diagram will indicate field wiring (dashed lines) to the supply valve, drain valve, and supply drain valve. Wire the valves as indicated on the unit wiring diagram.

Note: The valves can be provided by the factory or field-supplied by others. If field-supplied valves are utilized, the total inrush VA shall not exceed 160 VA and the total holding VA shall not exceed 66 VA with a 24 VAC supply.

#### 2. Freeze Protection Sensor

If the unit was provided with the auto drain and fill option and the evaporative cooling module was shipped separately, the freeze protection sensor must be field-wired. The freeze protection sensor will be factory installed to the bottom side of the top louver on the unit intake. Wire the freeze sensor as indicated on the unit wiring diagram (dashed lines).

#### 3. Single Pass Water Control Valves

The unit may have been provided with the single pass control valve option. If this option has been provided, the unit wiring diagram will indicate field wiring (dashed lines) to the supply valve and supply drain valve. Wire the valves as indicated on the unit wiring diagram.

NOTE: The valves can be provided by the factory or field-supplied by others. If field-supplied valves are utilized, the total inrush VA shall not exceed 160 VA and the total holding VA shall not exceed 66 VA with a 24 VAC supply.

### Cooling Relay(s)

If the unit was provided with an optional chilled water coil or split DX coil, the cooling relay can provide an enable signal for the cooling system. When a call for cooling has been signaled, the cooling relay closes a dry NO contact rated for 8 amps and 250 VAC.

### Carbon Dioxide (CO<sub>2</sub>) Sensor

Depending on the application, recirculating units may have been provided with a wall mounted CO<sub>2</sub> sensor. The CO<sub>2</sub> sensor is intended to prevent the build-up of CO<sub>2</sub> in the space. It must be wired as indicated on the unit wiring diagram to command the unit to 100% outside air in the event CO<sub>2</sub> rises above the alarm setting. If a microprocessor is included with this unit, reference the supplemental *Microprocessor Controller for Make-Up Air Reference Guide* for more information.

### Fire Suppression System

The building fire suppression system is typically wired to shut down the unit in the event of a fire. A normally closed (NC) contact should be wired in series with unit enable switch or contact. This is located between terminals R and G on the wiring diagram. When the fire suppression system alarms, it shall open this contact removing 24 VAC power from terminal G which will disable the unit.

### Fire Stat Type III

The optional fire stat type III is shipped separately for field installation and wiring. The fire stat is typically installed in the return air duct to shut down the fan in the event of elevated temperature in the duct. The normally closed (NC) contact can be wired in series with the fire suppression contact to shut down the unit. The fire stat has additional contacts that can be used to alert an external system.

### Duct Smoke Detector

The optional duct smoke detector is shipped separately for field installation and wiring. The smoke detector is typically installed in the return air duct to shut down the fan in the event of a fire. The normally closed (NC) contact should be wired in series with the fire suppression contact to shut down the unit. The smoke detector has additional contacts that can be used to alert an external system.

## Optional Electrical Accessory Wiring

### Remote Panel

The optional remote panel is shipped separately for field installation and wiring.

24 VAC control wiring must be connected between the remote panel and the units control center.

All required field wiring is illustrated by dashed lines on the unit and remote panel ladder diagrams. These field connections are to be accomplished by point-to-point wiring from the remote panels terminal strip to the unit's terminal strip. Terminals are illustrated as squares surrounding the terminals ID. For unit specific wiring requirements please refer to the unit and remote panel wiring diagram for further illustration.

Note: Any sensor(s) or temperature adjustment dial(s) located on or in the remote panel must be run with shielded cable or in separate conduit.

Only the designated terminals shown with dashed lines on the unit and remote panel ladder diagrams should be used to establish field control connections. If other terminals are utilized it can result in component damage or failed unit operation.

### Control Voltage

Manufacturer's standard control voltage is 24 VAC. Control wire resistance must not exceed 0.75 ohms (approximately 285 feet total (86.9 m) length for 14 gauge wire; 455 feet (138.7 m) total length for 12 gauge wire). If the resistance exceeds 0.75 ohms, an industrial-style relay must be wired in place of the remote switch. The relay must be rated for at least 5 amps and have a 24 VAC coil. Failure to comply with these guidelines may cause motor starters to chatter or not pull in, resulting in contactor failures and/or motor failures.

### Room Temperature Sensing Devices

One of the following sensors or equivalent may have been provided and will require field wiring. Refer to the unit wiring diagram for terminal designations. If a microprocessor is included with this unit, reference the supplemental *Microprocessor Controller for Make-Up Air Reference Guide* for more information.

#### Room Override Thermostat

Requires wiring to be run in separate conduit or run with shielded cable.



#### Room Thermostat

Requires wiring to be run in separate conduit or run with shielded cable.



#### Unit Controller Room Temperature Sensor

Requires wiring to be run in separate conduit or run with shielded cable.



#### Night Setback Thermostat (occupied/unoccupied mode)



# Installation

## Piping

### Gas

All gas piping must be installed in accordance with the latest edition of the National Fuel Gas Code ANSI/Z223.1 and any local codes that may apply. In Canada, the equipment shall be installed in accordance with the Installation Code for Gas Burning Appliances and Equipment (CGA B149) and Provincial Regulations for the class. Consult authorities having jurisdiction before installations are made. All piping must be clean and free of any foreign matter. Foreign material entering the gas train can damage the valves, regulators and burner.

Do not connect the unit to gas types other than what is specified and do not connect the unit to gas pressures that are outside of the pressure range shown on the label.

When connecting the gas supply, the length of the run must be considered in determining the pipe size to avoid excessive pressure drop. Refer to a Gas Engineer's Handbook for gas pipe capacities.

### WARNING

All components of this or any other gas-fired heating unit must be leak tested prior to placing the unit into operation. Use a soap and water solution or equivalent to perform this test. NEVER test for gas leaks with an open flame.

When leak testing pressures that are equal to 14 in. wg (3.5 kPa), first close the field-installed shutoff valve to isolate the unit from the gas supply line.

When leak testing pressures that are above 14 in. wg (3.5 kPa), close the field-installed shutoff valve, disconnect the furnace and gas train from the gas supply line, and plug the supply line before testing.

#### 1. Determine the Supply Gas Requirements

The unit's indirect gas nameplate states the requirements for the gas being supplied to the unit. The indirect gas nameplate is located on the outside of the unit on the control center side.

Type of Gas	TYPE OF GAS TYPE OF GAZ	NATURAL	TEMPERATURE RISE RANGE ELEVATION DE TEMPERATURE	20-100 F
	MAXIMUM EXTERNAL STATIC PRESSURE PRESSION STATIQUE EXTERIEUR MAXIMUM	3 IN.W.C. P.O.C.D'E	MANIFOLD PRESSURE PRESSION A LA TUBERIE D'ALIMENTATION	3.5 IN.W.C. P.O.C.D'E
	MINIMUM INPUT BTU/HR ENTREE CALORIFIQUE MINIMUM BT/HEURE	75,000	MINIMUM GAS SUPPLY PRESSURE PRESSION MINIMALE D'ALIMENTATION DU GAZ	6 IN.W.C. P.O.C.D'E

Minimum Gas Supply Pressure

Indirect Gas Nameplate

#### 2. Furnaces

If unit is provided with multiple furnaces, each furnace must be considered its own appliance. The following steps will pertain to each individual furnace.

#### 3. Install Additional Regulator if Required

When the supply gas pressure exceeds the maximum gas pressure shown on the indirect gas nameplate, an additional regulator is required to reduce the pressure. The regulator must be a full lock up type. Additionally, it must incorporate a listed leak limiting device or be vented to the outdoors.

#### 4. Connect the Supply Gas Line

A manual shut off valve, 1/8 in. plugged test port and 6 in. drip leg must be installed prior to the gas train. The valve and the test port must be accessible for the connection of a test gauge. Supply gas connections must be made by a qualified installer and are not furnished by manufacturer.

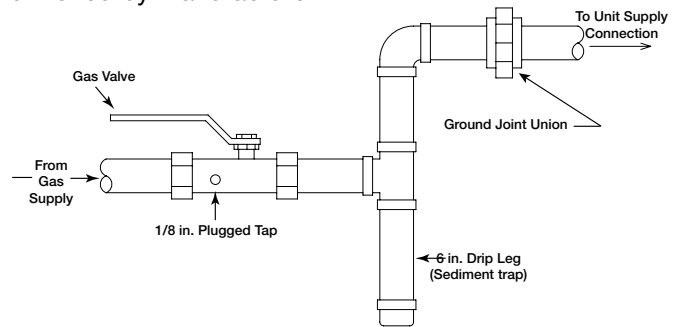

Supply Gas Line

#### 5. Test the System for Leaks

### WARNING

NEVER test for a gas leak with an open flame.

Check both the supply lines and the factory piping for leaks. Apply a soap and water solution or equivalent to all piping and watch for bubbling which indicates a leak.

The factory piping has been checked for leaks, but must be rechecked due to possible movement during shipping and installation.

# Installation

## Piping

### Optional Evaporative Cooling Module

#### Recirculating Pump

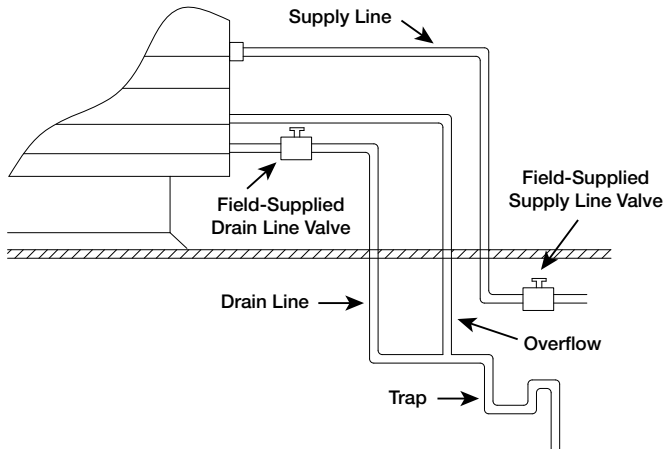

#### Single Pass

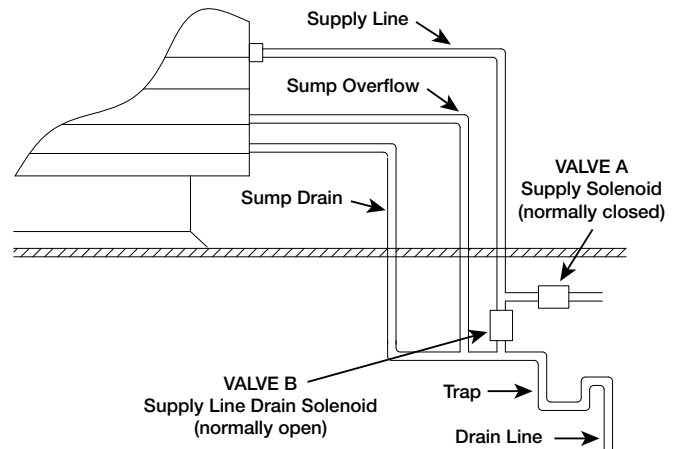

#### Auto Drain and Fill

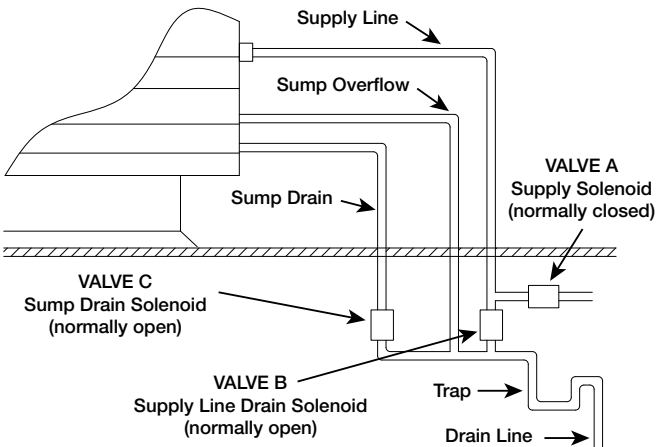

Mfg. Part Number	ASCO Part Number	Solenoid Type	De-Energized Position	Diameter	Qty.
461262	8210G2	Supply	Closed	1/2 inch (13 mm)	1
461263	8262G262	Supply Line Drain	Open	1/4 inch (6 mm)	1

Part numbers subject to change.

All three solenoid valves are different. Make sure to use the proper solenoid for each location. Check your local code requirements for proper installation of this type of system.

Note: The valves can be provided by the factory or field-supplied by others. If field-supplied valves are utilized, the total inrush VA shall not exceed 160 VA and the total holding VA shall not exceed 66 VA with a 24 VAC supply.

All solenoid valves and traps must be installed below the roof to protect the supply water line from freezing. If they cannot be installed below the roof, an alternative method must be used to protect the lines from freezing.

Auto Drain & Fill Valves (when provided by manufacturer)						
Assm. Number	Mfg. Part Number	ASCO Part Number	Solenoid Type	De-Energized Position	Diameter	Qty.
852178	461262	8210G2	Supply	Closed	1/2 inch (13 mm)	1
	461263	8262G262	Supply Line Drain	Open	1/4 inch (6 mm)	1
	461264	8210G35	Sump Drain	Open	3/4 inch (19 mm)	1

Part numbers subject to change.

### CAUTION

Provisions must be taken to prevent damage to the evaporative cooling section during freezing conditions. The sump, drain lines and supply lines must be drained prior to freezing conditions or an alternate method must be used to protect the lines and media.



# Installation

## Piping

### Optional Evaporative Cooling Module *(continued)*

#### 1. Install the Water Supply Line

Supply line opening requirements vary by unit size and arrangement. Connect the water supply line to the float valve. A field-provided opening must be created for the supply line.

The supply line must be of adequate size and pressure to resupply the amount of water lost due to bleed-off and evaporation. The drain line should be the same size or larger than the sump tank drain connection.

**Auto Drain and Fill or Single Pass** - Install the 1/2 in. normally closed solenoid (Valve A) in the supply line. Install the 1/4 in. normally open solenoid (Valve B) between the supply line and the drain line.

#### 2. Install the Drain Line

**Recirculating Pump** - Connect an unobstructed drain line to the drain and overflow connections on the evaporative cooling module. A shut off valve (by others) is required in the drain line. A trap must be provided for proper unit drainage.

**Auto Drain and Fill** - Connect an unobstructed drain line to the sump overflow connection. Install the 3/4 in. normally open solenoid (Valve C) between the sump drain connection and the drain line. A trap must be provided for proper unit drainage.

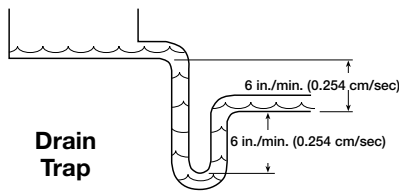

**Single Pass** - Connect an unobstructed drain line to the sump drain and overflow connections. A trap must be provided for proper unit drainage.

#### 3. Check/Adjust Water Level

Check the water level in the sump tank. The water level must be above the pump intake and below the overflow. Adjust the float as needed to achieve the proper water level. The float can be adjusted by bending the float lever arm. The single pass system does not use a float valve and does not retain water in the sump tank.

Note: The manufacturer recommends that units equipped with evaporative cooling be installed outdoors. If an evaporative cooling module must be installed indoors, it is recommended that a field-supplied secondary drain pan be installed under the evaporative cooling section. This will help mitigate damage to building materials in the event the evaporative cooling module sump tank overflows.

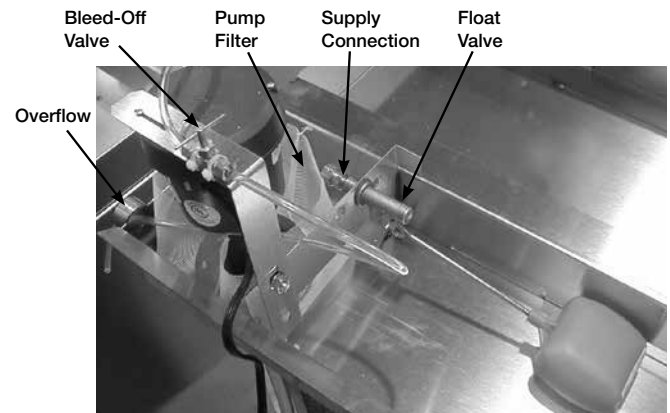

Evaporative Cooling Module Set-Up

# Installation

## Piping

### Optional Split Direct Expansion (DX) Coil

Guidelines for the installation of direct expansion (DX) cooling coils have been provided to ensure proper performance and longevity of the coils. These are general guidelines that may have to be tailored to meet the requirements of a specific installation. Qualified personnel must perform the installation and maintenance of any coil. Proper protective equipment is recommended during the installation and maintenance of the coil.

All field-brazing and welding must be performed using high quality materials and an inert gas purge (such as nitrogen) to reduce oxidation of the internal surface of the coil.

All field-piping must be self-supporting and flexible enough to allow for the thermal expansion of the coil and piping.

#### 1. Locate the Distributor(s)

A field-provided opening must be created for the liquid line(s). The distributor(s) are located behind the distributor access panel.



Distributor Access Panel

#### 2. Verify Nozzle Placement

Inspect the refrigerant distributor and verify that the nozzle is in place. The nozzle is generally held in place by a retaining ring or is an integral part of the distributor itself. The nozzle is not a metering device. A thermostatic expansion valve (TXV) must be field-supplied.

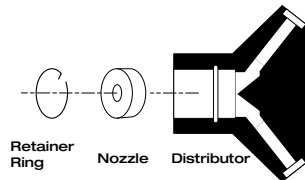

#### 3. Install Suction Line

Install suction line(s) from the compressor(s) to the suction connection(s) which are stubbed through the side of the cabinet.

#### 4. Install the Liquid Line and Thermostatic Expansion Valve (TXV) (by others)

Liquid line openings vary by coil size and circuiting and are field-supplied. Follow the TXV recommendations for installation to avoid damaging the valve. If the valve is externally equalized, use a tubing cutter to cut off the plugged end of the factory installed equalizer line. Use a de-burring tool to remove any loose metal from the equalizer line and attach it to the TXV. If the valve is internally equalized, the factory-installed equalizer line can be left as is. If a hot gas bypass kit was provided by others, refer to the manufacturer's instructions.

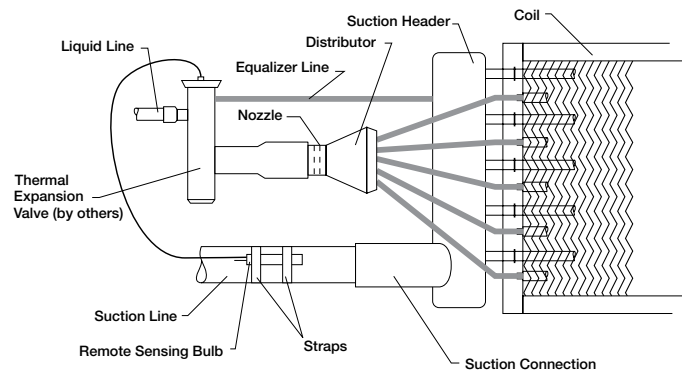

General Installation

#### 5. Mount the TXV Sensing Bulb (by others)

Mount the TXV sensing bulb to the horizontal run of the suction line at the TXV manufacturer's recommended position and insulate it.

#### 6. Check System for Leaks

Pressurize the coil to 100 psig with dry nitrogen. Leave the system pressurized for a minimum of 10 minutes. If the system holds the pressure, the hook-up can be considered leak free. If the pressure drops by 5 psig or less, re-pressurize the system and wait another 10 minutes. If the pressure drops again, there is likely one or more small leaks which must be located and repaired. Pressure losses greater than 5 psig indicate a large leak that must be isolated and repaired.

#### 7. Evacuate and Charge the System

Use a vacuum pump to evacuate the system. Measure the vacuum in the system using a micron gauge located as far from the pump as possible. Evacuate the system to 500 microns or less, and then close the valve between the pump and the system. If the vacuum holds to 500 microns or less for one minute, the system is ready to be charged.

A steady rise in vacuum pressure indicates that moisture is still present and that the system must be further vacuumed until the moisture has been removed.

Failure to obtain a vacuum of 500 microns or less indicates a great deal of moisture or a leak. Break the vacuum with a charge of dry nitrogen and recheck for leaks. If no leaks are found, continue vacuuming the coil until the desired vacuum is reached.

#### 8. Install the Drain Line

Connect an unobstructed drain line to the drain pan. A trap must be provided for proper unit drainage.

All traps must be installed below the roof line or be otherwise protected from freezing.

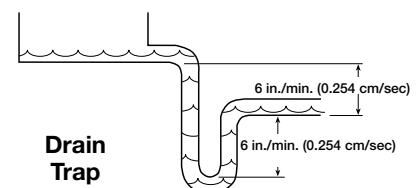

### Optional Chilled Water Coil

Guidelines for the installation of chilled water cooling coils have been provided to ensure proper performance and longevity of the coils. These are general guidelines that may have to be tailored to meet the requirements of a specific installation. Qualified personnel must perform the installation and maintenance of any coil. Proper protective equipment is recommended during the installation and maintenance of the coil.

When installing couplings, do not apply undue stress to the connection. Use a backup pipe wrench to avoid breaking the weld between the coil connection and the header.

All field-piping must be self-supporting. System piping must be flexible enough to allow for the thermal expansion and contraction of the coil and piping.

#### 1. Verify Coil Hand Designation

Check the coil hand designation to ensure that it matches the system. Coils are generally plumbed with the supply connection located on the bottom of the leaving air-side of the coil and the return connection at the top of the entering air-side of the coil. This arrangement provides a counter flow heat exchanger and positive coil drainage.

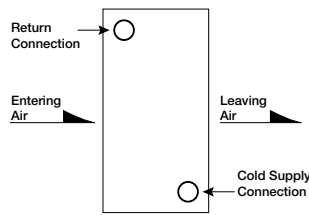

#### 2. Connect the Supply & Return Lines

Connect the supply and return lines as shown.

#### 3. Check the System for Leaks

Pressurize the system to 100 psig. Leave the system pressurized for a minimum of 10 minutes. If the system holds pressure, it can be considered leak free. If the pressure drops by 5 psig or less, re-pressurize the system and wait another 10 minutes. If the pressure drops again, there is likely one or more small leaks which must be located and repaired. Pressure losses greater than 5 psig indicate a large leak that must be isolated and repaired.

#### 4. Install the Drain Line

Connect an unobstructed drain line to the drain pan. A trap must be provided for proper unit drainage.

All traps must be installed below the roof line or be otherwise protected from freezing.

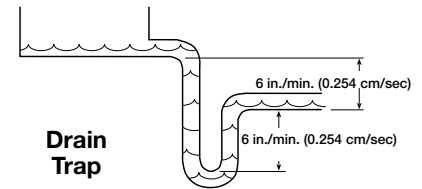

## Optional Components

### Building Pressure Control

#### 1. Mounting Pressure Sensor

Using the factory provided bracket, mount the pressure sensor outside of the building. The pressure sensor mounting location must be out of prevailing winds and away from supply or exhaust fans to assure accurate readings.



#### 2. Running Pressure Tap Lines

Connect and run a pressure tube from the pressure sensor outside of the building to the low pressure tap on the back of the Photohelic® gauge. Run a second pressure tube from the high pressure tap on the back of the Photohelic gauge to the space. If the Photohelic gauge is located in the space to be controlled, the high pressure tube is not required.

Note: Fifty feet of tubing is supplied with the unit. If further tubing is required, this must be supplied by others.

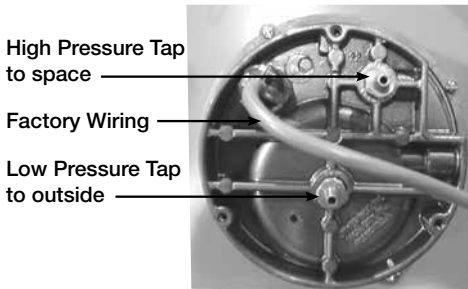

Connections for Photohelic® Gauge

#### 3. Setting the Desired Building Pressure

The Photohelic pressure gauge is used to set the desired building pressure. The pressure is set by adjusting the upper and lower pressure limits. A typical positive pressure setting is: 0.0 in. wg (0.0 kPa) for the lower and 0.10 in. wg (0.02 kPa) for the upper pressure setting.

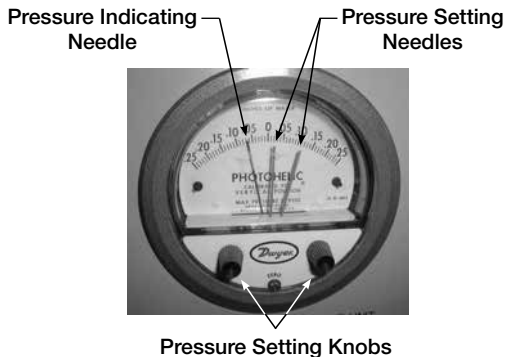

### Building Static Pressure Sensor (with microprocessor)

The controller will modulate the supply fan based upon a comparison of the building static pressure set point to the actual building static pressure level reported from the sensor. Sensor shipped loose.

### Duct Pressure Control

The optional microprocessor controller can be selected to modulate the supply fan based upon a comparison of the duct static pressure set point to the actual duct static pressure level reported from the sensor. The factory-supplied sensor will ship loose for field-mounting and wiring. Further component identification and terminal designation can be found by referencing the unit specific ladder diagrams and supplemental material supplied with the unit.

### Carbon Dioxide (CO<sub>2</sub>) Sensor

This sensor is intended to measure the CO<sub>2</sub> concentration in the ventilated space or return air duct. If the unit has been equipped with a microprocessor controller, the CO<sub>2</sub> sensor will modulate either the VFD or the return and outside air dampers based upon a comparison of the CO<sub>2</sub> set point to the actual CO<sub>2</sub> levels reported from the sensor. The duct mount or room mount sensor is shipped loose for field mounting and wiring.

### Duct-Mounted Smoke Detector

The duct smoke detector provides early detection of smoke present in the HVAC duct system. The smoke detector is designed to prevent the recirculation of smoke by the air handling system. Complete system shut down will occur in the event of smoke detection. The detector will operate on 115 or 24 VAC. Output terminals are provided for remote accessories such as a horn, strobe, remote status indicators and reset switches or push buttons.





# Supply Fan

## Fan Identification

### Mixed Flow Plenum Fans

Mixed flow plenum fans are single width, single inlet fans. The impellers are unshrouded with blades that curve away from the direction of rotation. These fans throw the air radially outward, approximately 45° from the inlet direction, pressurizing the fan cabinet. These fans are direct driven with the impeller mounted directly to the motor shaft. A "P" and "MF" are present in the model number.



Mixed Flow Plenum

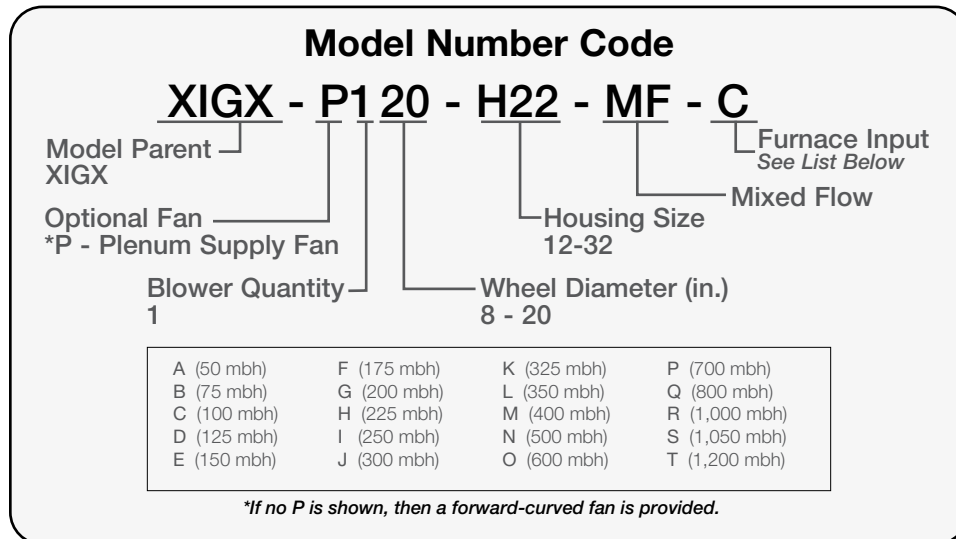

# Supply Fan

## Pre-Start Checks

### TOOLS REQUIRED

- Voltage Meter (with wire probes)
- Amperage Meter
- Pressure Gauges
- Tachometer
- Thermometer
- U-tube manometer or equivalent

### WARNING

Disconnect and lock-out all power and gas before performing any maintenance or service to the unit. Failure to do so could result in serious injury or death and damage to equipment.

Check the housing, fan, and ductwork for any foreign objects before running the fan.

Units with a direct drive backward-curved plenum supply fan must always be supplied with a Variable Frequency Drive (VFD) due to the direct drive arrangement on the supply fan. Before proceeding further, identify if this is a constant volume or Variable Air Volume (VAV) unit. Reference the *Start-Up: Indirect gas-Fired Heating, Optional Features, Variable Air Volume* section in this Installation, Operation, and Maintenance Manual for further information.

### 1. Check Electrical Connections

Tug test all internal electrical connections to ensure no loose connections occurred during shipment.

### 2. Check Fasteners for Tightness

Check fasteners, set screws and locking collars on the fan, bearings, drive, motor base, and accessories for tightness.

### 3. Check Supply Fan Clearance

The rotation of the supply fan wheel is critical. It must be free to rotate without striking or rubbing any stationary objects.

### 4. Check V-Belt Alignment (if applicable)

Check the V-belt drive for proper alignment and tension. Check the tension by measuring the deflection in the belt as shown.

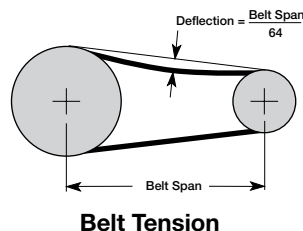

Check the alignment by using a straight edge across both sheaves. Differences in sheave width must be accounted for.

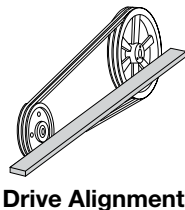

### 5. Check Plenum Fan Radial Overlap, Offset, Gap, and Wheel Alignment (if applicable)

#### Backward-Curved Plenum Fan Radial Overlap

Proper wheel and inlet cone overlap is shown in the chart. The overlap can be adjusted by loosening the setscrews in the wheel and moving the wheel to the correct position.

Fan Size	Overlap in. (cm)
P114	0.14 (0.36)
P115	0.25 (0.64)
P120	0.20 (0.51)
P125	0.26 (0.66)
P128	0.28 (0.71)

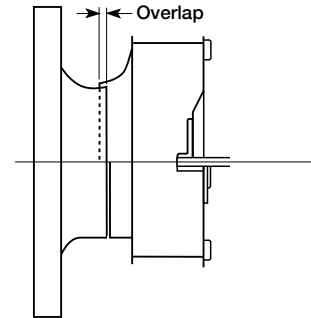

**Backward-Curved Plenum Fan Radial Overlap**

#### Backward-Curved Plenum Fan Radial Offset

Radial offset is adjusted by loosening the wheel hub from the shaft and moving the wheel to the desired position along the shaft. The correct radial offset between the inlet cone and wheel is shown in the chart. There is a smooth feel to the profile when moving from one component to the other.

Fan Size	Offset in. (cm)
P127	0.375 (0.95)
P222	0.250 (0.64)
P227	0.375 (0.95)

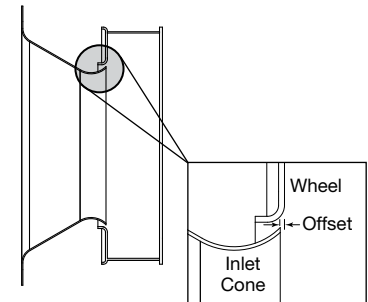

**Backward-Curved Plenum Fan Radial Offset**

#### Mixed Flow Plenum Fan Alignment

If necessary, adjust wheel position by loosening the wheel hub from the motor shaft. Adjust wheel position so that a straight edge held tight to the wheel cone just touches the inlet cone.

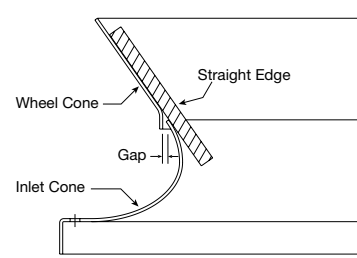

**Mixed Flow Alignment**



# Supply Fan

## Start-Up

### 1. Check Electrical Connections

Tug test all internal electrical connections to ensure no loose connections occurred during shipment.

### 2. Check Voltage

Before starting the unit, compare the supplied voltage, hertz, and phase with the unit and motor(s) nameplate information.

### 3. Check the Fan Rotation

Open the fan access door and run the fan momentarily to determine the rotation. If the fan is rotating in the wrong direction, the unit will move some air, but will not perform as designed. Be sure to perform a visual inspection to guarantee the correct fan rotation. Refer to the arrows to indicate the proper direction. To reverse the rotation of a three phase units, disconnect and lock-out the power, then interchange any two motor leads. To reverse the rotation of a single phase units, disconnect and lock-out the power, then rewire the motor per the manufacturer's instructions.

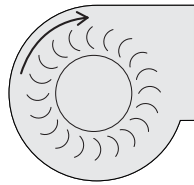

**Forward-Curved Fan Rotation**

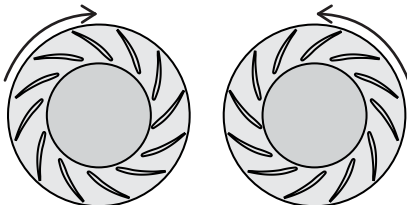

**Backward-Curved Plenum Rotation**

*(May be clockwise or counterclockwise as viewed from inlet)*

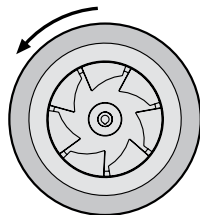

**Mixed Flow Plenum Rotation**

*(Always counterclockwise as viewed from inlet)*

### 4. Check for Vibration

Check for unusual noise, vibration or overheating of the bearings.

Excessive vibration may be experienced during the initial start-up. Left unchecked, it can cause a multitude of problems including structural and/or component failure.

Generally, fan vibration and noise is transmitted to other parts of the building by the ductwork. To minimize this undesirable effect, heavy canvas duct connectors can be used.

### 5. Motor Check

Measure the motor's voltage, amps and RPM. Compare to the specifications. Motor amps can be reduced by lowering the fan RPM or increasing system static pressure.

Additional starters and overloads may be provided in the make-up air control center for optional external exhaust fans. Exhaust fan motor voltage must match unit nameplate voltage. Exhaust fan overloads must be set to exhaust fan motor Full Load Amps (FLA). Reference the exhaust fan manual for additional information.

### 6. Air Volume Measurement

To ensure accuracy, the dampers are to be open when measuring the air volume.

Measure the unit's air volume and compare it with its rated air volume. If the measured air volume is incorrect, adjust the fan's RPM by adjusting the variable pitch sheave, if equipped, or replacing the sheave(s) if necessary. Direct drive fan RPM must be adjusted by changing VFD parameters. Consult factory for more information.

The most accurate way to measure the air volume is by using a pitot traverse method downstream of the fan.

Changing the air volume can significantly increase the motor's amps. If the air volume is changed, the motor amp draw must be checked to prevent overloading the motor.

### 7. Optional VFD

If unit is equipped with VFD, verify if VFD is provided for a soft start/air balance in a constant volume configuration or used as variable volume to vary the supply fan speed. If unit is intended for variable volume, reference **Sequence of Operation, Optional Variable Air Volume** section in this IOM for more information.

# Start-Up: Indirect Gas-Fired Heating

## Optional Features

### Variable Air Volume (VAV)

Complete the *Supply Fan Pre-Start Checks and Start-Up* sections in this IOM before proceeding.

For maintenance issues associated with a variable frequency drive (VFD), consult the drive's manual supplied with the unit. The drives are programmed at the factory and rarely need any adjustment during installation and start-up. For some applications, the drive may be located in the building or in the unit.

The VAV option is recommended when a building's exhaust volume may vary. This option enables the make-up air volume to track the exhaust volume, providing only the amount of make-up air required. Control strategies include 2-speed and modulating options. Before the unit is left in service, test the variable air volume control system.

#### 2-Speed Option

A VFD is used on a single speed motor to control air volumes. The VFD is factory programmed for 2 speed operation and can be switched to low or high speed from a remote control panel. Turn the fan speed switch on the remote control panel to each position and confirm that the fan speed adjusts accordingly.

#### Modulating Options

##### Potentiometer Control

A VFD is controlled by input from a remote speed selector (potentiometer). This option allows easy manual adjustment of make-up air volumes.

To test potentiometer operation, turn the potentiometer to the two extremes. Make sure the fan goes to maximum and minimum speed. When the potentiometer is at minimum, the fan speed will be at its minimum. When the potentiometer is at maximum, the fan will be at its maximum speed.

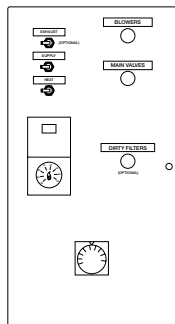

Potentiometer Control

##### Building Pressure Control

A VFD is controlled according to input from a pressure sensing device.

On the Photohelic® gauge, turn both pressure knobs to the upper most setting. The VAV system should go to maximum speed. Set both knobs at the lowest setting and the VAV system should go to minimum speed. Reset the correct pressure limits before starting the unit.

Typical settings are 0.0 in. wg (0 kPa) for the lower pressure setting and

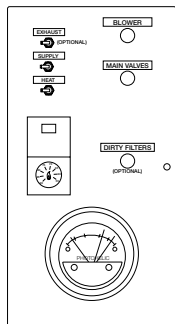

Building Pressure Control

Pressure Indicating Needle

Pressure Setting Needles



Pressure Setting Knobs

Photohelic® Gauge

0.10 in. wg (0.02 kPa) for the upper pressure setting. The needle indicates a negative building pressure. During correct operation, the indicating needle will remain between or near the setting needles.

#### External Signal

A VFD is controlled according to input from an external 2-10 VDC or 4-20 mA signal (by others).

A 2 VDC or 4 mA signal will send the fan to low speed. The fan will go to maximum speed with a 10 VDC or 20 mA signal.

#### Variable Kitchen Control

A VFD is controlled by input from a speed control signal from the kitchen hood. This unit allows automatic adjustment of make-up air volumes based on varying cooking loads.

#### Optional Duct Static Pressure Sensor

The controller will modulate the supply fan based upon a comparison of the duct static pressure set point to the actual duct static pressure level reported from the sensor. Sensor shipped loose.

#### Optional Building Static Pressure Sensor

The controller will modulate the supply fan based upon a comparison of the building static pressure set point to the actual building static pressure level reported from the sensor. Sensor shipped loose.

#### Control Voltage

Manufacturer's standard control voltage is 24 VAC. Control wire resistance must not exceed 0.75 ohms (approximately 285 feet total (86.9 m) length for 14 gauge wire; 455 feet (138.7 m) total length for 12 gauge wire). If the resistance exceeds 0.75 ohms, an industrial-style relay must be wired in place of the remote switch. The relay must be rated for at least 5 amps and have a 24 VAC coil. Failure to comply with these guidelines may cause motor starters to chatter or not pull in, resulting in contactor failures and/or motor failures.



# Start-Up: Indirect Gas-Fired Heating

## Optional Features

### Recirculation Operation

The recirculation operation option is recommended when the ventilation equipment provides the primary source of heating for the space or when exhaust fan tracking is required. Control strategies include 2-position option and modulating options. During commissioning, test the recirculation control system.

#### 2-Position Option

A 2-position spring return actuator is used to control the return air amounts. The damper moves from open to closed. If power is cut to the unit, the outdoor air damper will fail closed.

Turn the recirculating switch on the remote control panel to each position and confirm that the return air damper adjusts accordingly. The damper actuator may take a few minutes to open or close.

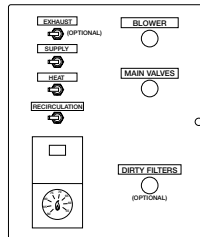

**2-Position Damper Control**

#### Modulating Options

##### Potentiometer Control

A modulating spring return actuator is used to control the return air amounts. The return air damper modulates from fully open to fully closed based on a signal from a remote potentiometer.

To test potentiometer operation, turn the potentiometer to the two extremes. Confirm that the return air damper fully opens and fully closes. When the potentiometer is at minimum, the return air damper will open. When the potentiometer is at maximum, the return air damper will close. The damper actuator may take a few minutes to open or close.

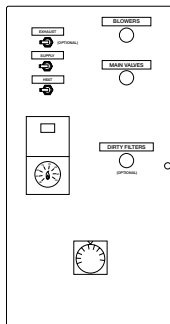

**Potentiometer Control**

##### Building Pressure Control

A floating point spring return actuator is used to control the return air amounts. The return air damper modulates from fully open to fully closed based on a signal from a remote pressure sensing device.

On the Photohelic® gauge, turn both knobs to the upper most pressure setting. You may have to remove the outdoor pressure tap tubing. The return air damper should close.

Set both knobs at the lowest setting and the damper should open. It may take one to two minutes for the damper to reach the desired position.

Reset the correct pressure limits before starting the unit.

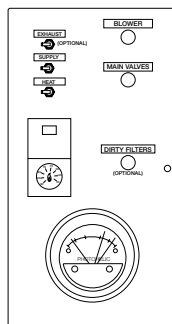

**Building Pressure Control**

Pressure Indicating Needle

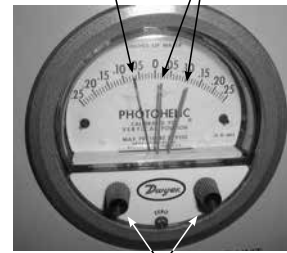

Pressure Setting Needles

Pressure Setting Knobs

**Photohelic® Gauge**

Typical settings are 0.0 in. wg (0 kPa) for the lower and 0.10 in. wg (0.02 kPa) for the upper pressure setting. The needle in this photo indicates a negative building pressure. During correct operation, the indicating needle will remain between or near the setting needles.

#### External Signal

A modulating spring return actuator is used to control the return air amounts. Return air damper modulates from fully open to fully closed based on an external 2-10 VDC or 4-20 mA signal (by others).

The return air damper will close with a 10 VDC or 20 mA signal. The return air damper should open with a 2 VDC or 4mA signal. The damper actuator may take a few minutes to open or close.

#### Optional Duct Static Pressure Sensor

The controller will modulate the supply fan based upon a comparison of the duct static pressure set point to the actual duct static pressure level reported from the sensor. Sensor shipped loose.

#### Optional Building Static Pressure Sensor

The controller will modulate the supply fan based upon a comparison of the building static pressure set point to the actual building static pressure level reported from the sensor. Sensor shipped loose.

#### Control Voltage

Manufacturer's standard control voltage is 24 VAC. Control wire resistance must not exceed 0.75 ohms (approximately 285 feet total (86.9 m) length for 14 gauge wire; 455 feet (138.7 m) total length for 12 gauge wire). If the resistance exceeds 0.75 ohms, an industrial-style relay must be wired in place of the remote switch. The relay must be rated for at least 5 amps and have a 24 VAC coil. Failure to comply with these guidelines may cause motor starters to chatter or not pull in, resulting in contactor failures and/or motor failures.

# Start-Up: Optional Features

## Evaporative Cooling Module

**Note:** For single pass, complete steps 1, 4, 5 and 6 only.

### 1. Check the Installation

The media may have been removed during installation, so its orientation should be checked. The media must be installed with the steeper flute angle sloping down towards the entering air side.

Verify that the stainless steel caps and distribution headers are in place. The headers are located over the media towards the entering air side. The caps must be placed over the headers.

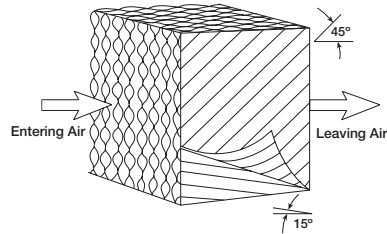

**Media Orientation**

### 2. Check the Pump Filter

Check that the pump filter is around the pump inlet.

### 3. Fill the Sump and Adjust the Float

Turn on the water supply and allow the sump tank to fill. Adjust the float valve to shut-off the water supply when the sump is filled to within 1 inch (2.54 cm) of the bottom of the overflow.

### 4. Break-In the Media

Open the ball valve completely and saturate the media with the fan(s) off for no less than 20 minutes.

A jumper will need to be installed in the control center to power the evaporative pumps or single pass valves with the fan(s) off. Reference the unit's ladder diagram to determine proper terminals.

### 5. Put the Unit into Service

Remove the jumper and energize the fan(s). Verify proper operation.

### 6. Check the Flow Rate

The pumps or water supply should provide enough water to saturate the media in 45 to 60 seconds with the fan running. Consult the factory if adequate flow is not achieved.

If too much water is flowing to the media, the flow can be adjusted using the manual ball valve. If flow adjustments are made, verify that sufficient water is still being supplied to the media to keep the entire pad wet during normal operation. Excessive water flow can result in water carryover problems. Insufficient water flow can result in mineral build-up.



**Manual Ball Valve**

### 7. Adjust the Water Bleed-Off Rate

The water bleed-off rate is dependent on the water's mineral content. After two weeks of service, adjust the bleed-off rate to eliminate mineral deposits on the media.

### 8. Set the Optional Auto Drain and Fill

This system will automatically drain the sump pan and fill it with fresh water at the field-adjustable intervals (factory default is once every 24 hours). The auto drain sequence reduces the mineral concentration within the sump pan to reduce maintenance and increase media pad life.

In addition, this system will protect the evaporative cooling module from freezing by draining the sump tank and supply line when the outside temperatures fall below the set point of the outside air sensor. This is set to 45°F (7.2°C) and is not adjustable.

#### Set the Timer Scale and Settings dials:

- **T1** timer setting set to **10** and timer scale set to **1d** for 1 day of operation
- **T2** timer setting set to **10** and the timer scale set to **10m** for 10 minutes of drain time

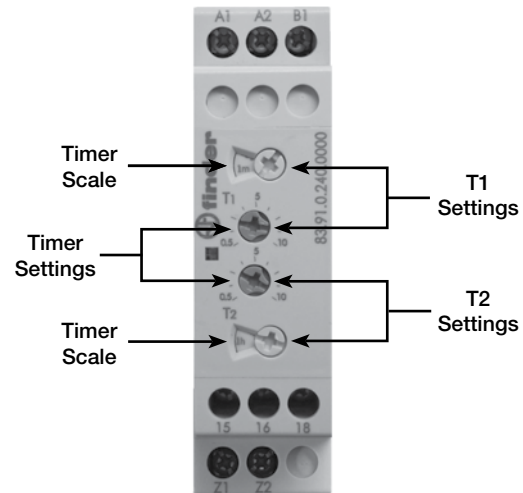

**Auto Drain and Fill Timer**

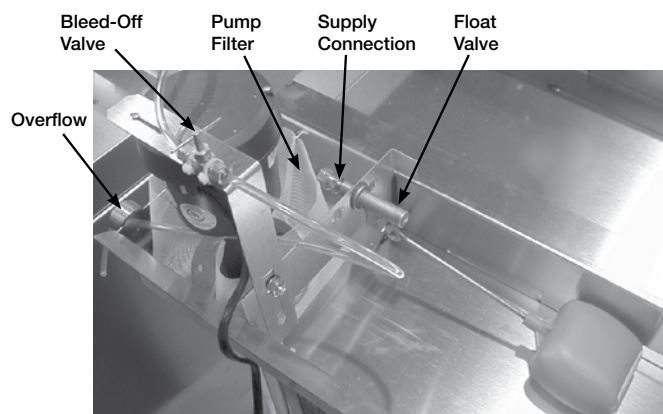

**Evaporative Cooling Module Set-Up**



## Start-Up: Optional Features

### Other

#### Building Freeze Protection

This option is intended to disable the unit supply fan in the event the discharge temperature falls below 35°F for five minutes. This is accomplished through electromechanical controls or a microprocessor. Building freeze protection is selected when the unit may operate while the space it serves is unoccupied.

#### Microprocessor Controls

The controller has been pre-programmed to offer multiple control sequences for providing tempered air. Easy monitoring and adjustment of unit parameters can be accomplished by way of the lighted graphical display and an integral push-button keypad or by way of the Building Management System (BMS) communication with the addition of an optional BMS communication card. This addition allows the user too remotely adjust set points, view unit status points and alarms. The sequence parameters are fully adjustable. For additional information, reference the supplemental Microprocessor Controller for Make-Up Air Reference Guide for more information.

#### Packaged Direct Expansion (PDX) Cooling Module

The PDX module is a complete package that has been designed for outdoor installations. The PDX system in the module is a complete, sealed unit with compressed R-410A refrigerant. It consists of one or two compressors, evaporator and condenser coils, and all other necessary components. Reference the supplemental *Packaged DX Module* IOM for more information.

#### Dirty Filter Switch

To adjust the switch, the unit must be running with all of the access doors in place, except for the compartment where the switch is located. The filters must be clean and in good condition. The adjusting screw is located on the top of the switch.

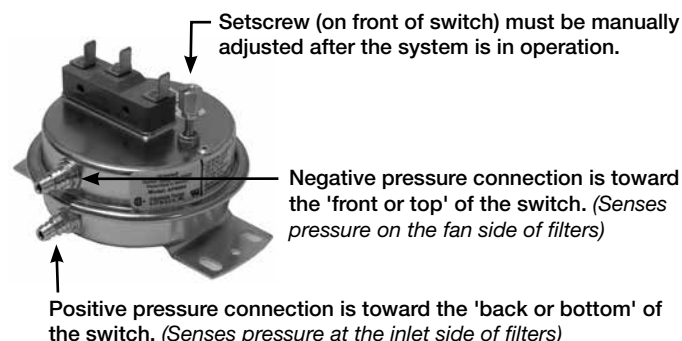

1. Open the filter compartment and place a sheet of plastic or cardboard over 50% of the filter media.

2. Close and secure the filter compartment door.
3. Check to see if there is power at the alert signal leads (refer to electrical diagram).
4. If power is present, turn the adjustment screw counterclockwise until the power goes off. Turn slightly clockwise until power comes back on. If power is not present, turn the adjustment screw clockwise until the power comes on.
5. Open the filter compartment and remove the obstructing material.
6. Close and secure the door and check to make sure there is no power at the alert signal leads. The unit is now ready for operation.

#### Heating and/or Cooling Inlet Air Sensor(s)

The heating inlet air sensor locks out heating operation when the inlet temperature rises above set point (field-adjustable). The cooling inlet air sensor locks out cooling when inlet temperature falls below set point (field-adjustable). These components are located in the unit's control center. Reference the unit's ladder diagram for component identification and terminal designation.

#### Inlet/Outlet Damper End Switch

Provides a damper actuator with an end switch that is wired into the unit's control center. This will prevent the supply fan from starting up until the end switch is proven. Reference the unit's ladder diagram for component identification and terminal designation.

## Sequence of Operation

If the unit has a microprocessor, reference the supplemental *Microprocessor Controller for Make-Up Air Reference Guide* for more information.

### OPTIONAL EXHAUST

#### Exhaust Fan Contact (S1) Closed (optional)

- Power passes to normally closed exhaust overload contact (ST2 OL).
- Power passes to exhaust starter(s) ST2.
- Normally open exhaust starters are energized and closed.
- Power passes to exhaust fans.
- Exhaust fan(s) (M2) start.

### SUPPLY FAN

#### Supply Fan Contact (S2) Closed

- Power passes through normally closed field-supplied fire system contact (FSC).
- Power passes through normally open exhaust fan contact (ST2), which is closed when the exhaust relay (ST2) is activated (optional).
- Power passes to normally closed supply overload contact (ST1 OL or VFD).
- Power passes through normally closed contact on optional freeze protection timer (RT4) which remains closed if the temperature has remained above the set point.
- Power passes to optional inlet damper which opens.
- When damper is fully opened, optional normally open damper limit switch (DL1) closes.
- Power passes to and energizes supply starter relay (RF).
- Power passes to normally open fan contact (RF), which is energized and closed.
- Supply starter (ST1) or variable frequency drive (VFD) is energized.
- Supply starter contact (ST1) closes or VFD is energized and power reaches and energizes supply fan.
- Supply fan (M1) starts.

### HEATING

#### Heat Contact (S4) Closed

- Power passes to normally open fan relay (RF or ST1) which is energized and closed.
- Power passes to optional inlet air sensor contact (TS4) which is closed if the inlet air temperature is below the set point.
- Power passes to and energizes the heat relay (RH).
- Normally open heat relay contact (RH) closes.

### OPTIONAL COOLING

#### Optional Cooling Contact (S4) Closed

- Power passes to normally open fan relay (RF or ST1) which is energized and closed.
- Power passes to optional inlet air sensor contact (TS5) which is closed if the inlet air temperature is below the set point.
- Power passes to and energizes cooling relay (RC).
- Cooling sequence begins.

#### Cooling Sequence - Recirculating Pump Evaporative Cooling

- Whenever the cooling relay (RC) is energized, power passes through the normally open cooling relay to the evaporative cooling pump (P1).
- The evaporative cooling pump(s) are energized and cooling begins.

#### Cooling Sequence - Auto Drain and Fill Evaporative Cooling

- Power passes to the evaporative cooling module freeze sensor (FRZ) which is closed if the incoming air temperature is above the set point.
- Power passes to the auto drain and fill timer (TC) and the supply drain valve (VSD).
- The supply drain valve is energized and closed.

#### Run Time Period

- During the run time period, the auto drain and fill timer (TC) passes power to the auto drain relay (RA) and to the auto drain valves (VS, VD).
- The normally closed supply valve (VS) is energized and opens. The normally open drain valve (VD) is energized and closes. The normally open supply drain valve (VSD) is energized and closes. This allows water to fill the evaporative cooling sump.
- When the cooling relay (RC) and the auto drain relay (RA) are energized, power passes through the normally open cooling relay (RC) contacts and the normally open auto drain relay (RA) contacts to the evaporative cooling pump(s) (P1).
- The evaporative cooling pump(s) are energized and cooling begins.

#### Drain Time Period

- When the run time period expires, the auto drain relay (RA) and the auto drain valves (VS, VD) are de-energized. The drain time period begins.
- When the auto drain relay (RA) is de-energized, the normally open auto drain relay (RA) contacts open and the evaporative cooling pump(s) are de-energized.
- When the normally closed supply valve (VS) is de-energized, the water supply to the evaporative cooling module sump is stopped.
- When the normally open drain valve (VD) is de-energized, the evaporative cooling sump is drained.





## Sequence of Operation

### Freeze Condition

- If the incoming air temperature is below the evaporative cooling module freeze sensor (FRZ) set point, the freeze sensor (FRZ) contacts will open, de-energizing the auto drain and fill timer (TC) and the supply drain valve (VSD).
- When the normally closed supply valve (VS) and the normally open supply drain valve (VSD) are de-energized, the supply line is drained.
- When the normally open drain valve (VD) is de-energized, the evaporative cooling module sump is drained.

### Cooling Sequence - Chilled Water or Split System DX Cooling

- Modulating or staged controls for chilled water and split system DX coils are supplied by others. The sequence of operation will depend on the controls provided.
- The cooling relay (RC) normally open contacts may be used to initiate the cooling sequence for the controls supplied by others.

### OPTIONAL VARIABLE VOLUME

#### Two Speed VFD Control

- When the supply fan relay (RF) is energized, the normally open supply fan relay (RF) contacts are closed. This creates a run command for the VFD.
- The run command allows the VFD to pass power to the supply fan (M1). The supply fan (M1) will operate at maximum speed.
- When the two speed supply fan contact (S2) is switched to the low position, power is passed to the low speed relay (RL) which is energized.
- The normally open low speed relay (RL) contacts are closed commanding the VFD to low speed.
- The VFD controls supply fan M1 to operate at minimum speed.

#### Potentiometer VFD Control

- When the supply fan relay (RF) is energized, the normally open supply fan relay (RF) contacts are closed. This creates a run command for the VFD.
- The run command allows the VFD to pass power to the supply fan (M1). The supply fan (M1) will operate at the speed commanded by the potentiometer.
- The potentiometer will output a 2-10 VDC signal to the VFD analog input terminal. A 2 VDC signal will command the VFD to minimum speed. A 10 VDC signal will command the VFD to maximum speed.
- The VFD controls the supply fan motor (M1) to the speed commanded by the potentiometer.

### External Signal VFD Control

- When the supply fan relay (RF) is energized, the normally open supply fan relay (RF) contacts are closed. This creates a run command for the VFD.
- The run command allows the VFD to pass power to the supply fan (M1). The supply fan (M1) will operate at the speed commanded by the external signal provided by others.
- The external signal provided by others will send a 2-10 VDC or a 4-20 mA signal to the VFD analog input terminal. A 2 VDC or 4mA signal will command the VFD to minimum speed. A 10 VDC or 20 mA signal will command the VFD to maximum speed.
- The VFD controls the supply fan motor (M1) to the speed commanded by the external signal.

### Building Pressure VFD Control

- When the supply fan relay (RF) is energized, the normally open supply fan relay (RF) contacts are closed. This creates a run command for the VFD.
- The run command allows the VFD to pass power to the supply fan (M1). The supply fan (M1) will operate at minimum speed.
- The photohelic building pressure controller will monitor the pressure differential between the pressure in the controlled space and the pressure outside the controlled space.
- If the pressure differential is below the set point range established on the photohelic controller, the VFD will increase the supply fan speed.
- If the pressure differential is above the set point range established on the photohelic controller, the VFD will decrease the supply fan speed.
- If the pressure differential is within the set point range established on the photohelic controller, the VFD will maintain the supply fan at its current speed.

### OPTIONAL RECIRCULATION

#### Two Position Recirculation Control

- Power passes to inlet damper which opens.
- When damper is fully opened, normally open damper limit switch (DL1) closes.
- Power passes to and energizes supply starter relay (RF).
- Power passes to normally open fan contact (RF), which is energized and closed. Power reaches and energizes supply fan. The recirculation damper is closed.
- When the recirculation contact (S3) is closed, the recirculation damper is opened to allow recirculated air to enter the unit and mix with the heated outside air.

## Sequence of Operation

### Potentiometer Recirculation Control

- Power passes to inlet damper which opens.
- When damper is fully opened, normally open damper limit switch (DL1) closes.
- Power passes to and energizes supply starter relay (RF).
- Power passes to normally open fan contact (RF), which is energized and closed. Power reaches and energizes supply fan.
- The potentiometer will output a 2-10 VDC signal to the recirculation damper actuator to control recirculation damper position.

### External Signal Recirculation

- Power passes to inlet damper which opens.
- When damper is fully opened, normally open damper limit switch (DL1) closes.
- Power passes to and energizes supply starter relay (RF).
- Power passes to normally open fan contact (RF), which is energized and closed. Power reaches and energizes supply fan.
- An external source will provide a 2-10 VDC or 4-20 mA signal to the recirculation damper actuator to control recirculation damper position.

### Building Pressure Recirculation Control

- Power passes to inlet damper which opens.
- When damper is fully opened, normally open damper limit switch (DL1) closes.
- Power passes to and energizes supply starter relay (RF).
- Power passes to normally open fan contact (RF), which is energized and closed. Power reaches and energizes supply fan.
- The photohelic building pressure controller will monitor the pressure differential between the pressure in the controlled space and the pressure outside the controlled space.
- If the pressure differential is below the set point range established on the photohelic controller, the recirculation damper will be modulated further closed.
- If the pressure differential is above the set point range established on the photohelic controller, the recirculation damper will be modulated further open.
- If the pressure differential is within the set point range established on the photohelic controller, the recirculation damper will remain in its current position.

### OPTIONAL NIGHT SETBACK

#### Night Setback Schedule

- The night setback schedule is established within the programmable thermostat on the remote panel. The schedule must be set for the occupied and unoccupied hours of the controlled space.

#### Night Setback Fan Control

- During occupied hours, the fan sequence of operation is the same as that described in the "Supply Fan" section.
- During unoccupied hours the fan is turned off.
- If there is a call for heating from the space thermostat, the fan will be turned on to allow for tempering operation.
- When the call for heating from the space thermostat ends, the fan will be turned off.

#### Night Setback Heat Control

- During occupied hours, the heating sequence of operation is the same as that described in the "Heat" sections.
- During unoccupied hours, the unit is off until there is a call for heating from the space thermostat. When the unit is enabled by a call for heat from the space thermostat, the heat is also enabled and the discharge temperature overridden to a maximum value to provide the maximum amount of heat to the space.
- When the call for heating from the space thermostat ends, the unit will be turned off.

#### Night Setback Variable Volume Control

- During occupied hours, the variable volume sequence of operation is the same as that described in the "Optional Variable Volume" section.
- During unoccupied hours, the unit is off until there is a call for heating from the space thermostat. When the unit is enabled by a call for heat from the space thermostat, the supply fan will run at minimum speed.
- When the call for heating from the space thermostat ends, the unit will be turned off.

#### Night Setback Recirculation Control

- During occupied hours, the recirculation sequence of operation is the same as that described in the "Optional Recirculation" section.
- During unoccupied hours, the unit is off until there is a call for heating from the space thermostat. When the unit is enabled by a call for heat from the space thermostat, the recirculation damper will be opened to provide a maximum amount of recirculated air to the unit.
- When the call for heating from the space thermostat ends, the unit will be turned off.



# Maintenance

## General

### CAUTION

Lock-out the gas and the electrical power to the unit before performing any maintenance or service operations to this unit.

### V-Belt Drives (if applicable)

V-belt drives must be checked on a regular basis for wear, tension, alignment, and dirt accumulation.

Check the tension by measuring the deflection in the belt as shown.

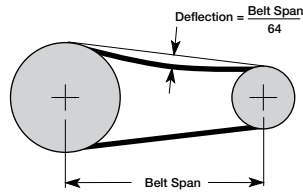

**Belt Tension**

Check the alignment by using a straight edge across both sheaves. Differences in sheave width must be accounted for.

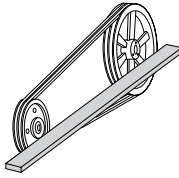

**Drive Alignment**

Premature or frequent belt failures can be caused by improper belt tension, or misaligned sheaves.

- Abnormally high belt tension or drive misalignment will cause excessive bearing loads and may result in failure of the fan and/or motor bearings.
- Abnormally low belt tension will cause excessive squealing on start-up, excessive belt flutter, slippage, and overheated sheaves.

Do not pry belts on or off the sheave. Loosen belt tension until belts can be removed by simply lifting the belts off the sheaves.

When replacing V-belts on multiple groove drives, all belts should be changed to provide uniform drive loading.

Do not install new belts on worn sheaves. If the sheaves have grooves worn in them, they must be replaced before new belts are installed.

### Snow Accumulation

Clear snow away from roof mounted units. Keep the snow clear of the intake and access doors.

### Supply Wheels

Supply wheels require little attention when moving clean air. Occasionally oil and dust may accumulate on the wheel causing imbalance. When this occurs, the wheel and housing should be cleaned to assure proper operation.

### Bearings (if applicable)

Fan bearings are carefully selected to match the maximum load and operating conditions of the specific class, arrangement and fan size. The instructions provided in this manual and those provided by the bearing manufacturer will minimize any bearing problems.

Lubricate bearings prior to periods of extended shutdowns or storage and rotate shaft monthly to aid in corrosion prevention. If the fan is stored more than three months, purge the bearings with new grease prior to start-up.

Recommended Bearing Lubrication Schedule (in months*)					
Fan RPM	Bearing Bore Size (inches)				
	1/2 - 1	1 1/8 - 1 1/2	1 5/8 - 1 7/8	1 15/16 - 2 3/16	2 7/16 - 3
250	6	6	6	6	6
500	6	6	6	5	4
750	6	5	4	3	3
1000	5	3	2	1	1
1250	5	3	2	1	1
1500	5	2	1	1	0.5
2000	5	1	1	0.5	0.25

\*Suggested initial greasing interval is based on 12 hour per day operation and 150°F (65.6°C) maximum housing temperature. For continuous (24 hour) operation, decrease greasing interval by 50%

- If extended grease lines are present, relubricate while in operation, only without endangering personnel.
- For ball bearings (operating) relubricate until clean grease is seen purging at the seals. Be sure not to unseat the seal by over lubricating.
- For ball bearings (idle) add 1-2 shots of grease up to 2 inch bore size, and 4-5 shots above 2 inch bore sizes with a hand grease gun.
- For roller bearings add 4 shots of grease up to 2 inch bore size, and 8 shots for 2-5 inch bore size with a hand grease gun.
- Adjust relubrication frequency based on condition of purged grease.
- A high quality lithium based grease conforming to NLGI Grade 2 consistency, such as those listed here:

Mobil 532	Texaco Multifak #2	B Shell Alavania #2
Mobilux #2	Texaco Premium #2	Exxon Unirex #2

# Maintenance

## General

### Motors

Motor maintenance is generally limited to cleaning and lubrication (where applicable).

Limit cleaning to exterior surfaces only. Removing dust and grease build-up on the motor assures proper motor cooling.

Grease motors supplied with grease fittings in accordance with the manufacturer's recommendations.

Do not allow water or solvents to enter the motor or bearings. Never spray motors and bearings with steam, water or solvents.

Greasing motors is only intended when fittings are provided. Many motors are permanently lubricated, requiring no additional lubrication.

### Filters

Filter maintenance is generally limited to cleaning and replacement.

If aluminum mesh filters are installed, they can be washed in warm soapy water.

An adhesive spray can be added to aluminum mesh filters to increase their efficiency.

If disposable filters are installed, they can be checked by holding up to a light source. If light cannot pass through the filter, it must be replaced.

When reinstalling filters, be sure to install them with the airflow in the correct direction. An airflow direction arrow is located on the side of the filters.

Replacement filters must be from the same manufacturer and the same size as the original filters provided with the unit.

### Chilled Water Coils

Test the circulating fluid for sediment, corrosive products and biological contaminants. Take the necessary corrective measures.

Maintain adequate fluid velocities and proper filtering of the fluid.

If automatic air vents are not utilized, periodic venting of the coil is recommended to remove accumulated air.

### Evaporative Cooling Module

The media must periodically be brushed lightly with a soft bristle brush in an up and down motion while flushing with water. This aids in reducing the amount of mineral build-up.

For large amounts of mineral build-up, clean or replace the media and increase the water bleed-off or drain and fill rate.

The cooling media has a useful life of 3 to 5 years depending on the water quality and the bleed-off or drain and fill rate.

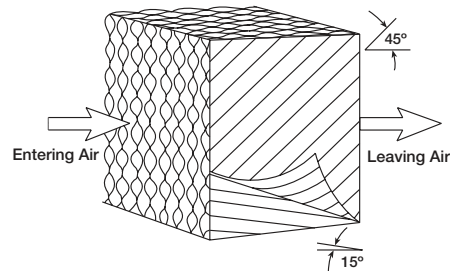

**Media Orientation**

When reinstalling the evaporative media, make sure that it is installed correctly.

Replacement media must be from the same manufacturer and be the same size as the original media provided with the unit.

### Cooling Coils

Repair and replacement of the coil and the connecting piping, valves, etc., must be performed by a qualified individual.

Inspect the coil for signs of corrosion and/or leaks. Repair any leaks as required.

Inspect the coil's surface for foreign material. If the coil surface needs cleaning, clean the coil from the leaving air-side so that foreign material will be washed out of the coil rather than pushed farther in.

Inspect and clean the drain pan to prevent the growth of algae and other organisms.

Be sure to read and follow the coil manufacturer's recommendations before using any cleaning fluid.

Caution must be used to avoid injury when venting the coil. High pressure and/or high temperature fluids can cause serious injuries.



# Maintenance

## Seasonal: Heating/Cooling

### Start-Up

Repeat *Supply Fan, Pre-Start Checks and Start-Up; Pre-Start: Indirect gas-Fired Heating; and Start-Up: Indirect gas-Fired Heating* sections in this IOM. This will ensure that the gas and air are set properly before the heating season begins and should lead to trouble free operation all winter.

### Gas Train

Check the gas connections, joints and valves annually for tightness. Apply a soap and water solution to all piping; watch for bubbling which indicates a leak.

### Evaporative Cooling Module

Shut off the water and drain all exposed lines when the outside temperature drops below 45°F (7.2°C).

Clean all interior parts of any mineral deposits or foreign materials that may have built-up during the cooling season.

Replace any worn or non-functioning parts.

### Winterizing Chilled Water Coils

During the winter, chilled water coils need to be protected against freezing. Manufacturer recommends protecting the coils by either blowing-out the coils or by flushing the coils.

### Blowing-Out Coils

1. Close valves on the supply and return lines.
2. Open drain valves and/or drain plug. Remove vent plug to allow coil to drain faster.
3. After coil is fully drained, connect a blower to the caps. Do not connect the blower to the air vent or drain plug.
4. Close the vent plug on the header that the blower is connected to. Open the drain valve or cap on the other header.
5. Turn on blower for 30 minutes. Place mirror at discharge. If the mirror fogs up, repeat procedure until no fog appears on the mirror.
6. After drying the coil, wait a few minutes then repeat Step #5.
7. Leave drains open and do not install plugs until beginning of cooling season.

### Flushing Coils

Manufacturer recommends the use of inhibited glycol (such as propylene or ethylene) to flush water coils to protect against freezing. Additionally, the use of inhibited glycol provides corrosion protection.

The table below indicates the percentage of glycol required to prevent freezing in a coil at a given outdoor air freeze point. Completely fill coil with solution. Drain coil. Residual glycol fluid per these concentrations can be left in the coil without concern of freezing. Recovered fluid can be used to flush other coils.

Percent of Ethylene Glycol by Volume	Freeze Point		Percent of Propylene Glycol by Volume	Freeze Point	
	°F	°C		°F	°C
0	32	0	0	32	0
10	25	-4	10	26	-3
20	16	-9	20	19	-7
30	3	-16	30	8	-13
40	-13	-25	40	-7	-22
50	-34	-37	50	-28	-33
60	-55	-48	60	-60	-51

### Combustion Blower Motor

Motor maintenance is generally limited to cleaning. Cleaning should be limited to exterior surfaces only. Removing dust and grease build-up on the motor housing assures proper motor cooling. Use caution and do not allow water or solvents to enter the motor or bearings. Under no circumstances should motors or bearings be sprayed with water, steam or solvents. The motor bearings are pre-lubricated and sealed, requiring no further lubrication.

### Burners and Orifices

---

Before each heating season, examine the burners and gas orifices to make sure they are clear of any debris such as spider webs, etc. Clean burner as follows:

- Turn off both electrical and gas supplies to the unit.
- Disconnect the union between manifold and gas valve.
- Remove burner manifold and burner assembly.
- Inspect and clean orifices and burners as necessary. Avoid using any hard or sharp instruments which could cause damage to the orifices or burners.
  - a. Remove any soot deposits from the burner with a wire brush.
  - b. Clean the ports with an aerosol degreaser or compressed air.
  - c. Wipe the inside of the burner clean. Cleaning the burner with a degreaser will slow the future buildup of dirt.
- Before reinstalling the burner assembly, look down the heat exchanger tubes to make sure they are clear of any debris.
- Reinstall manifold and burner assembly, reconnect wire leads and gas supply piping.
- Turn on the electrical power and gas supply.
- Follow the start-up procedure to light the burners and verify proper operation.

### Heat Exchanger

---

The heat exchanger should be checked annually for cracks and discoloration of the tubes. If a crack is detected, the heat exchanger should be replaced before the unit is put back into operation. If the tubes are dark gray, airflow across the heat exchanger should be checked to make sure the blower is operating properly.

### Flue Collector Box

---

The flue passageway and flue collector box should be inspected prior to each heating season and cleared of any debris.

### Electrical Wiring

---

The electrical wiring should be inspected annually for loose connections or wiring deterioration.

### Gas Train

---

The gas train connections, joints and valves should be checked annually for tightness.

### Replacement Parts

---

When ordering replacement parts, include the complete unit model number and serial number as shown on the unit labels.



# Troubleshooting

## Supply Fan

### Problem: Fan does not operate.

Line voltage across L1 & L2, L2 & L3, and L1 & L3 on main disconnect (DS1)?	Yes ↓	No →	<b>Main incoming power not connected.</b> Connect proper supply power to unit.
Line voltage across T1 & T2, T2 & T3, and T1 & T3 on main disconnect (DS1)	Yes ↓	No →	<b>Main disconnect (DS1) open or defective.</b> Close, repair, or replace.
24 VAC across R and C?	Yes ↓	No →	<b>Main transformer (TR1) circuit breaker tripped.</b> Reset transformer circuit breaker. If circuit breaker continues to trip, inspect circuit for improper wiring or grounding. <b>Main transformer (TR1) failed.</b> Replace main transformer. <b>Phase monitor (PM) contact open.</b> Correct incoming phase order at disconnect. <b>Fuse (FU6) blown.</b> Test and replace blown fuse(s).
24 VAC across G and C?	Yes ↓	No →	<b>Fan switch (S2) open or not wired.</b> Close or wire fan switch. <b>Fire system contact (FSC) tripped/not installed.</b> Correct or replace. <i>If fan switch and fire system contact is not required, place jumper from R to G to make the fan run continuously.</i>
24 VAC across A2 and A1 on the RF relay?	Yes ↓	No →	<b>Freeze protection tripped.</b> Cycle disconnect to reset. <b>Supply fan overload tripped.</b> Push reset button on overload or VFD to reset. Check motor amp draw and correct as necessary. <b>Damper limit switch (D1L) not closed.</b> <b>Damper stuck closed or actuator failed.</b> Repair damper interference or replace actuator. <b>Exhaust fan contactor not powered.</b> Close or wire exhaust switch, reset exhaust overload, or replace faulty exhaust contactor.
24 VAC across A2 and A1 on the supply contactor (ST1)?	Yes ↓	No →	<b>RF relay failure.</b> Check for loose connection or bent relay pins, repair or replace relay.
Line voltage across L1 & L2, L2 & L3, and L1 & L3 on supply starter (ST1)?	Yes ↓	No →	<b>Supply motor fuse (FU1) blown.</b> Test and replace blown fuse(s).
Line voltage across T1 & T2, T2 & T3, and T1 & T3 on supply starter (ST1)?	Yes ↓	No →	<b>Supply starter contact (ST1) not closed.</b> Replace contactor.
Line voltage across T1 & T2, T2 & T3, and T1 & T3 on supply starter overload (ST1OL)?	Yes ↓	No →	<b>Supply overload (ST1OL) faulty.</b> Replace overload.
Is motor operating?	Yes ↓	No →	<b>Motor wired incorrectly.</b> Check and correct motor wiring. <b>Defective motor/capacitor.</b> Repair or replace.
Is the fan operating?	Yes ↓	No →	<b>Broken fan belt.</b> Replace. Reference Maintenance, General, V-Belt Drives.

Everything is working properly, consult factory.

### Problem: Too much airflow.

Fan speed too high?	No ↓	Yes →	<b>Adjust drives or VFD as needed.</b> Reference Supply Fan, Start-Up.
Filters in place?	Yes ↓	No →	<b>Install filters.</b>
Insufficient external static pressure?		Yes →	<b>Increase external static pressure.</b>

Everything is working properly, consult factory.

# Troubleshooting

## Supply Fan

### Problem: Motor overamps.

Motor voltage correct?	Yes ↓	No →	<b>Provide proper power supply.</b> Reference Supply Fan, Start-Up.
Fan rotation correct?	Yes ↓	No →	<b>Reverse fan rotation.</b> Reference Supply Fan, Start-Up.
Air volume too high?	No ↓	Yes →	<b>Adjust drives or increase external static pressure as needed.</b> Reference Supply Fan, Start-Up.
Actual static pressure lower than design?	No ↓	Yes →	<b>Adjust drives to reduce fan RPM.</b> Reference Supply Fan, Start-Up.
All three phases supplied to motor?	Yes ↓	No →	<b>Supply motor fuse (FU1) blown.</b> Test and replace blown fuse(s).
Motor horsepower too low?	No ↓	Yes →	<b>Resize motor.</b>
Shorted windings in motor?		Yes →	<b>Replace motor.</b>
Everything is working properly, consult factory.			

### Problem: Insufficient airflow.

Damper(s) not fully opened?	No ↓	Yes →	<b>Adjust damper linkage(s), or replace faulty actuator(s).</b> Damper actuators may take a few minutes to open.
Fan rotation correct?	Yes ↓	No →	<b>Reverse fan rotation.</b> Reference Supply Fan, Start-Up.
Filters dirty or clogged?	No ↓	Yes →	<b>Clean or replace filters.</b> Reference Maintenance, General, Filters.
Belt slipping or broken?	No ↓	Yes →	<b>Replace or tighten belt.</b> Reference Maintenance, General, V-Belt Drives.
Fan speed too low?	No ↓	Yes →	<b>Adjust drives as needed.</b> Reference Supply Fan, Start-Up section.
System static losses too high?	No ↓	Yes →	<b>Reduce losses by improving ductwork.</b>
Leaks in ductwork?		Yes →	<b>Repair leaks.</b>
Everything is working properly, consult factory.			

### Problem: Excessive noise or vibration.

Belts worn or loose?	No ↓	Yes →	<b>Replace worn belts or tighten loose belts.</b> Reference Maintenance, General, V-Belt.
Sheaves aligned?	Yes ↓	No →	<b>Align sheaves.</b> Reference Maintenance, General, V-Belt Drives.
Wheel(s) unbalanced?	No ↓	Yes →	<b>Clean and/or balance wheel(s).</b>
Bearings worn or need lubrication?	No ↓	Yes →	<b>Replace worn bearings or lubricate bearings as needed.</b> Reference Maintenance, General, Bearings.
Wheel(s) rubbing on inlet?	No ↓	Yes →	<b>Adjust wheel(s) or inlet.</b>
Fan rotation correct?	Yes ↓	No →	<b>Reverse fan rotation.</b> Reference Supply Fan, Start-Up.
Everything is working properly, consult factory.			





# Troubleshooting

## Furnace

For complete furnace information reference the Indirect Gas-Fired Heat Modules IOM. Available turndown control options include:

Electronic Modulation	
Single Furnace Unit	4:1- uses modulating valve and furnace controller
	*High turndown uses a 4:1 modulating valve with a proprietary manifold and furnace controller
Two Furnace Unit	8:1- uses one 4:1 modulating furnace with furnace controller and one 2-stage furnace
	4:1 - uses two 4:1 modulating furnaces controlled in parallel
	*High turndown furnaces in a series configuration use one high turndown furnace and one 2-stage furnace
	*High turndown furnaces in a parallel configuration use two high turndown furnaces, controlled in parallel
Three Furnace Unit	12:1 - uses one 4:1 modulating furnace, one 2 stage furnace and one 1-stage furnace
	*High turndown uses one high turndown furnace, one 2-stage furnace, and one 1-stage furnace

\* High turndown furnace patent pending.

Staged	
Single Furnace Unit	8 stage

# Troubleshooting

## Evaporative Cooling

### Problem: Evaporative Cooling Module Does Not Operate - Recirculating Pump Control

Is fan operating correctly?	Yes ↓	No →	<b>Refer to Troubleshooting, Supply Fan.</b>
24 VAC between terminals Y1 and C	Yes ↓	No →	<b>Cool switch (S4) off.</b> Turn cool switch (S4) on. <b>Cool switch not wired.</b> Wire cool switch (S4). <i>If a cool switch is not required and a cooling inlet air sensor is provided, place jumper from R to Y1 to allow the cooling to enable based on the cooling inlet air sensor.</i>
24 VAC between terminal A2 and A1 on cooling relay (RC)?	Yes ↓	No →	<b>Optional inlet air sensor (TS4) holding.</b> Adjust TS4 setting. Reference Blower, Start-Up. <b>Fan Interlock (ST1 or RF) open.</b> Refer to Troubleshooting, Supply Fan.
Line voltage at primary side of TR3?	Yes ↓	No →	<b>Transformer fuses (FU7) blown.</b> Check and replace blown fuse(s).
115 VAC between terminals 102 and 101?	Yes ↓	No →	<b>Transformer secondary fuses (FU8) blown.</b> Check and replace blown fuse(s). <b>Transformer TR3 wired incorrectly.</b> Refer to wiring diagram on transformer and correct wiring. <b>Transformer TR3 faulty.</b> Replace transformer.
115 VAC between terminals 116 and 101?	Yes ↓	No →	<b>Cooling relay (RC) failure.</b> Check for loose connections or bent relay pins, repair or replace relay.
Evaporative cooling pump(s) (P1) running?	Yes ↓	No →	<b>Evaporative cooling pump(s) (P1) wired incorrectly or not wired.</b> Correct any wiring issues. <b>Evaporative cooling pump(s) (P1) faulty.</b> Replace evaporative cooling pump(s).

Everything is working properly, consult factory.



# Troubleshooting

## Evaporative Cooling

### Problem: Evaporative Cooling Module Does Not Operate - Auto Drain and Fill Control

Is fan operating correctly?	Yes ↓	No →	<b>Refer to the Troubleshooting, Supply Fan.</b>
24 VAC between terminals Y1 and C	Yes ↓	No →	<b>Cool switch (S4) off.</b> Turn cool switch (S4) on. <b>Cool switch not wired.</b> Wire cool switch (S4). <i>If a cool switch is not required and a cooling inlet air sensor is provided, place jumper from R to Y1 to allow the cooling to enable based on the cooling inlet air sensor.</i>
24 VAC between terminal A2 and A1 on cooling relay (RC)?	Yes ↓	No →	<b>Optional inlet air sensor (TS4) holding.</b> Adjust TS4 setting. Reference Supply Fan, Start-Up. <b>Fan Interlock (ST1 or RF) open.</b> Refer to Troubleshooting, Supply Fan.
24 VAC between terminals 62 and 61?	Yes ↓	No →	<b>Auto drain transformer TR2 circuit breaker tripped.</b> Reset transformer circuit breaker. If circuit breaker continues to trip, inspect circuit for improper wiring or grounding. <b>Auto drain transformer TR2 failed.</b> Replace auto drain transformer.
24 VAC between terminals 7 and 61?	Yes ↓	No →	<b>Inlet air temperature below evap freeze protection sensor (FRZ) set point.</b> Allow inlet air temperature to rise above 55°F. <b>Evap freeze protection sensor (FRZ) not wired.</b> Wire evap freeze protection sensor. <b>Evap freeze protection sensor (FRZ) failed.</b> Replace evap freeze protection sensor.
Time ranges on auto drain timer set correctly?	Yes ↓	No →	<b>Set time ranges to the values shown on the ladder diagram.</b>
Auto drain timer in drain mode?	No ↓	Yes →	<b>Wait for the drain mode timer to expire (usually 10 minutes).</b>
24 VAC between terminals 8 and 61?	Yes ↓	No →	<b>Auto drain timer (TC) wiring issue.</b> Inspect and correct wiring issue. <b>Auto drain timer (TC) faulty.</b> Replace auto drain timer.
Evaporative cooling module sump filled?	Yes ↓	No →	<b>Auto drain valves (VS,VD,VSD) not wired.</b> Wire auto drain valves. <b>Auto drain valve(s) failed.</b> Replace failed valve(s).
24 VAC between terminals A2 and A1 on RA relay?	Yes ↓	No →	<b>Wiring issue to RA relay.</b> Inspect and correct wiring.
Line voltage at primary side of TR3?	Yes ↓	No →	<b>Transformer fuses (FU7) blown.</b> Check and replace blown fuse(s).
115 VAC between terminals 102 and 101?	Yes ↓	No →	<b>Transformer secondary fuses (FU8) blown.</b> Check and replace blown fuse(s). <b>Transformer TR3 wired incorrectly.</b> Refer to wiring diagram on transformer and correct wiring. <b>Transformer TR3 faulty.</b> Replace transformer.
115 VAC between terminal 14 on RC relay and 101?	Yes ↓	No →	<b>Auto drain relay (RA) failure.</b> Check for loose connections or bent relay pins, repair or replace relay.
115 VAC between terminals 116 and 101?	Yes ↓	No →	<b>Cooling relay (RC) failure.</b> Check for loose connections or bent relay pins, repair or replace relay.
Evaporative cooling pump(s) (P1) running?	Yes ↓	No →	<b>Evaporative cooling pump(s) (P1) wired incorrectly or not wired.</b> Correct any wiring Issues. <b>Evaporative cooling pump(s) (P1) faulty.</b> Replace evaporative cooling pump(s).

Everything is working properly, consult factory.

# Troubleshooting

## Evaporative Cooling

### Problem: Evaporative Cooling Module Does Not Operate - Single Pass Control

Is fan operating correctly?	Yes ↓	No →	<b>Refer to the Troubleshooting, Supply Fan.</b>
24 VAC between terminals Y1 and C	Yes ↓	No →	<b>Cool switch (S4) off.</b> Turn cool switch (S4) on. <b>Cool switch not wired.</b> Wire cool switch (S4). <i>(If a cool switch is not required and a cooling inlet air sensor is provided, place jumper from R to Y1 to allow the cooling to enable based on the cooling inlet air sensor).</i>
24 VAC between terminal A2 and A1 on cooling relay (RC)?	Yes ↓	No →	<b>Optional inlet air sensor (TS4) holding.</b> Adjust TS4 setting. Reference Supply Fan, Start-Up. <b>Fan Interlock (ST1 or RF) open.</b> Refer to Troubleshooting, Supply Fan.
24 VAC between terminals 62 and 61?	Yes ↓	No →	<b>Single pass transformer TR2 circuit breaker tripped.</b> Reset transformer circuit breaker. If circuit breaker continues to trip, inspect circuit for improper wiring or grounding. <b>Single pass transformer TR2 failed.</b> Replace cooling transformer.
24 VAC between terminals 8 and 61?	Yes ↓	No →	<b>Cooling relay (RC) failure.</b> Check for loose connections or bent relay pins, repair or replace relay.
Water flowing to media?	Yes ↓	No →	<b>Manual ball valve closed.</b> Open and adjust ball valve. <b>Single pass valves (VS, VSD) not wired.</b> Wire single pass valves. <b>Single pass valve(s) failed.</b> Replace failed valve(s).

Everything is working properly, consult factory.

### Problem: Water Blows through Evaporative Cooling Module

Are the headers in place and located near the entering air side of the media?	Yes ↓	No →	<b>Replace headers and/or move the headers.</b> Reference Start-Up: Optional Features, Evaporative Cooling Module.
Water supply to header too high?	No ↓	Yes →	<b>Use the header control valve to reduce the supply of water.</b>
Air velocity greater than specified?		Yes →	<b>Reduce the air velocity through the media.</b> Reference Supply Fan, Start-Up.

Everything is working properly, consult factory.



## Typical Control Center Layout

### Blower Control Center

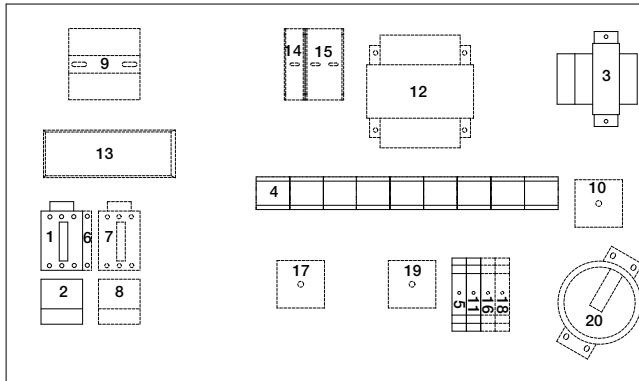

#### Note

This is a typical blower control center, the control center in your unit may be different. Reference the ladder diagram on the inside of the control center door for a unit specific wiring diagram.

1. **Supply Motor Starter/VFD** - 24 volt magnetic contacts for starting supply motor.
2. **Supply Overload/VFD** - Provides electronic overload protection to supply motor.
3. **Low Voltage Transformer** - Provides low voltage to fan/heat/cooling enable controls.
4. **Control Terminal Block** - Provides wiring access to controls.
5. **Fan Relay** - Allows power to pass to energize motor starter.
6. **Auxiliary Contact (Optional)** - Provides one normally closed and one normally open contact for other equipment.
7. **Exhaust Motor Starter (Optional)** - 24 volt magnetic contacts for starting exhaust motor.
8. **Exhaust Overload (Optional)** - Provides electronic overload protection to exhaust motor.
9. **Exhaust Fuses (Optional)** - Provides proper fusing for exhaust fan motor(s).
10. **Building Freeze Protection Timer (Optional)** - Prevents the discharge of cold air into the building.
11. **Heat Relay** - Allows power to pass to heating controls.
12. **Low Voltage Transformer** - Provides low voltage to the optional evaporative cooling controls.
13. **Microprocessor (Optional)**
14. **Evaporative Cooling Fuses (Optional)** - Provides proper fusing to evaporative cooling pump and controls.
15. **Transformer Fuse (Optional)** - Provides proper fusing for evaporative cooling transformer.
16. **Cooling Relay (Optional)** - Allows power to pass to cooling controls.
17. **Reset Timer (Optional)** - Resets cooling system to run a time interval.
18. **Auto Drain Relay (Optional)** - Assures supply pump does not operate during drain interval. Allows pump to operate in cooling mode.
19. **Cooling Timer (Optional)** - Allows for automatic draining of the evaporative cooling system based on time schedule.
20. **Dirty Filter Switch (Optional)** - Monitors filter pressure drop. Turns on indicating light when pressure drop is above field adjustable set point.

# Reference

## Start-Up Checklist

Unit Model Number \_\_\_\_\_  
(e.g. XIGX-120-H32)

Unit Serial Number \_\_\_\_\_  
(e.g. 10111000)

Start-Up Date \_\_\_\_\_

Start-Up Personnel Name \_\_\_\_\_

Start-Up Company \_\_\_\_\_

Phone Number \_\_\_\_\_

### Pre Start-Up Checklist

*Check boxes as items are completed.*

- Check tightness of all factory wiring connections
- Verify control wiring wire gauge
- Hand-rotate fan to verify free rotation
- Verify supply voltage to the main disconnect
- Verify the supply gas pressure
- Verify remote controls wiring

### Start-Up Fan Checklist

- Check line voltage L1-L2 \_\_\_\_\_  
L2-L3 \_\_\_\_\_  
L1-L3 \_\_\_\_\_
- Check fan rotation
- Check for vibration
- Supply fan RPM \_\_\_\_\_ RPM
- Motor nameplate amps \_\_\_\_\_ Amps
- Actual motor L1 \_\_\_\_\_ Amps  
L2 \_\_\_\_\_ Amps  
L3 \_\_\_\_\_ Amps
- Actual CFM/kPA delivered \_\_\_\_\_ CFM/kPA

### Optional Accessories

- Heating Inlet Air Sensor  
\_\_\_\_\_ Actual Setting  
• *Typical setting 60°-70°F (15.6° - 21.1°C)*
- Cooling Inlet Air Sensor  
\_\_\_\_\_ Actual Setting  
• *Typical setting 75°F (23.9°C)*
- Building Freeze Protection  
• *Typical setting 5 minutes; 35°F (1.7°C)*
- Dirty Filter Gauge  
\_\_\_\_\_ Actual Setting  
• *Typical setting varies*

### Start-Up Indirect Gas Furnace 1

- Determine furnace control type:  
High Turndown - 8 Stage - 4:1 Modulation
- Check supply gas pressure  
\_\_\_\_\_ Maximum  
\_\_\_\_\_ Minimum  
\_\_\_\_\_ Actual
- Set the High Manifold pressure  
\_\_\_\_\_ in. wg
- Set the Low Manifold pressure  
\_\_\_\_\_ in. wg
- Set the unit's desired discharge temperature  
\_\_\_\_\_ °F (°C)

### Furnace 2 (Optional)

- Determine furnace control type:  
High Turndown - 8 Stage - 4:1 Modulation
- Check supply gas pressure  
\_\_\_\_\_ Maximum  
\_\_\_\_\_ Minimum  
\_\_\_\_\_ Actual
- Set the High Manifold pressure  
\_\_\_\_\_ in. wg
- Set the Low Manifold pressure  
\_\_\_\_\_ in. wg

### Furnace 3 (Optional)

- Determine furnace control type:  
High Turndown - 8 Stage - 4:1 Modulation
- Check supply gas pressure  
\_\_\_\_\_ Maximum  
\_\_\_\_\_ Minimum  
\_\_\_\_\_ Actual
- Set the High Manifold pressure  
\_\_\_\_\_ in. wg
- Set the Low Manifold pressure  
\_\_\_\_\_ in. wg

### Start-Up Evaporative Cooling (optional)

*Refer to Evaporative Cooling Start-Up section for further detail.*

- Check media orientation
- Check for proper water flow to distribution headers
- Check for distribution header orientation to prevent water spillage



# Reference

## Maintenance Log

Date \_\_\_\_\_ Time \_\_\_\_\_ AM/PM

Notes: \_\_\_\_\_

---

---

---

---

Date \_\_\_\_\_ Time \_\_\_\_\_ AM/PM

Notes: \_\_\_\_\_

---

---

---

---

Date \_\_\_\_\_ Time \_\_\_\_\_ AM/PM

Notes: \_\_\_\_\_

---

---

---

---

Date \_\_\_\_\_ Time \_\_\_\_\_ AM/PM

Notes: \_\_\_\_\_

---

---

---

---

Date \_\_\_\_\_ Time \_\_\_\_\_ AM/PM

Notes: \_\_\_\_\_

---

---

---

---

Date \_\_\_\_\_ Time \_\_\_\_\_ AM/PM

Notes: \_\_\_\_\_

---

---

---

---

Date \_\_\_\_\_ Time \_\_\_\_\_ AM/PM

Notes: \_\_\_\_\_

---

---

---

---

Date \_\_\_\_\_ Time \_\_\_\_\_ AM/PM

Notes: \_\_\_\_\_

---

---

---

---

Date \_\_\_\_\_ Time \_\_\_\_\_ AM/PM

Notes: \_\_\_\_\_

---

---

---

---

Date \_\_\_\_\_ Time \_\_\_\_\_ AM/PM

Notes: \_\_\_\_\_

---

---

---

---

Date \_\_\_\_\_ Time \_\_\_\_\_ AM/PM

Notes: \_\_\_\_\_

---

---

---

---

Date \_\_\_\_\_ Time \_\_\_\_\_ AM/PM

Notes: \_\_\_\_\_

---

---

---

---



## Our Commitment

---

*As a result of our commitment to continuous improvement, Accurex reserves the right to change specifications without notice.*

Product warranties can be found online at [accurex.com](https://accurex.com), either on the specific product page or in the Warranty section of the website at [Accurex.com/Resources/Warranty](https://accurex.com/Resources/Warranty).



P.O. Box 410 Schofield, WI 54476  
Phone: 800.333.1400 • Fax: 715.241.6191  
Parts: 800.355.5354 • [accurex.com](https://accurex.com)