

## Installation, Operation and Maintenance Manual

Please read and save these instructions for future reference. Read carefully before attempting to assemble, install, operate or maintain the product described. Protect yourself and others by observing all safety information. Failure to comply with instructions could result in personal injury and/or property damage!

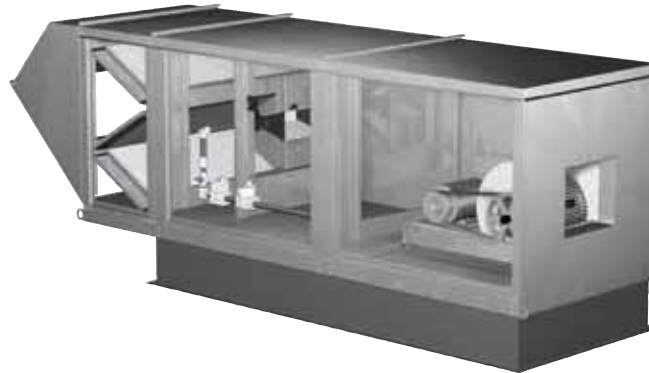

### General Safety Information

Only qualified personnel should install this unit. Personnel should have a clear understanding of these instructions and should be aware of general safety precautions. Improper installation can result in electric shock, possible injury due to coming in contact with moving parts, as well as other potential hazards. Other considerations may be required if high winds or seismic activity are present. If more information is needed, contact a licensed professional engineer before moving forward.

1. Follow all local electrical and safety codes, as well as the National Electrical Code (NEC), the National Fire Protection Agency (NFPA), where applicable. Follow the Canadian Electrical Code (CEC) in Canada.
2. The rotation of the wheel is critical. It must be free to rotate without striking or rubbing any stationary objects.
3. Motor must be securely and adequately grounded.
4. Do not spin fan wheel faster than the maximum cataloged fan rpm. Adjustments to fan speed significantly affects motor load. If the fan RPM is changed, the motor current should be checked to make sure it is not exceeding the motor nameplate amps.
5. Do not allow the power cable to kink or come in contact with oil, grease, hot surfaces, or chemicals. Replace cord immediately if damaged.
6. Verify that the power source is compatible with the equipment.
7. Never open blower access doors while the fan is running.

#### DANGER

Always disconnect power before working on or near a unit. Lock and tag the disconnect switch or breaker to prevent accidental power up.

#### CAUTION

When servicing the unit, motor may be hot enough to cause pain or injury. Allow motor to cool before servicing.

#### FOR YOUR SAFETY

If you smell gas:

1. Open windows.
2. Do not touch electrical switches.
3. Extinguish any open flame.
4. Immediately call your gas supplier.

#### FOR YOUR SAFETY

The use and storage of gasoline or other flammable vapors and liquids in open containers in the vicinity of this appliance is hazardous.

#### WARNING

Improper installation, adjustment, alteration, service or maintenance can cause property damage, injury or death. Read the installation, operating and maintenance instructions thoroughly before installing or servicing this equipment.

## Receiving

Upon receiving the product, check to ensure all items are accounted for by referencing the delivery receipt or packing list. Inspect each crate or carton for shipping damage before accepting delivery. Alert the carrier if any damage detected. The customer will make notation of damage (or shortage of items) on the delivery receipt and all copies of the bill of lading with is countersigned by the delivering carrier. If damaged, immediately contact your Accurex Representative. Any physical damage to the unit after acceptance is not the responsibility of the manufacturer.

## Unpacking

Verify that all required parts and the correct quantity of each item have been received. If any items are missing, report shortages to your local representative to arrange for obtaining missing parts. Sometimes it is not possible that all items for the unit be shipped together due to availability of transportation and truck space. Confirmation of shipment(s) must be limited to only items on the bill of lading.

## Handling

Units are to be rigged and moved by the lifting brackets provided or by the skid when a forklift is used. Location of brackets varies by model and size. Handle in such a manner as to keep from scratching or chipping the coating. Damaged finish may reduce ability of unit to resist corrosion.

## Storage

Units are protected against damage during shipment. If the unit cannot be installed and operated immediately, precautions need to be taken to prevent deterioration of the unit during storage. The user assumes responsibility of the unit and accessories while in storage. The manufacturer will not be responsible for damage during storage. These suggestions are provided solely as a convenience to the user.

**INDOOR** — The ideal environment for the storage of units and accessories is indoors, above grade, in a low humidity atmosphere which is sealed to prevent the entry of blowing dust, rain, or snow. Temperatures should be evenly maintained between 30°F (-1°C) and 110°F (43°C) (wide temperature swings may cause condensation and “sweating” of metal parts). All accessories must be stored indoors in a clean, dry atmosphere.

Remove any accumulations of dirt, water, ice, or snow and wipe dry before moving to indoor storage. To avoid “sweating” of metal parts allow cold parts to reach room temperature. To dry parts and packages use a portable electric heater to get rid of any moisture build up. Leave coverings loose to permit air circulation and to allow for periodic inspection.

The unit should be stored at least 3½ in. (89 mm) off the floor on wooden blocks covered with moisture proof paper or polyethylene sheathing. Aisles between parts and along all walls should be provided to permit air circulation and space for inspection.

**OUTDOOR** — Units designed for outdoor applications may be stored outdoors, if absolutely necessary. Roads or aisles for portable cranes and hauling equipment are needed.

The fan should be placed on a level surface to prevent water from leaking into the unit. The unit should be elevated on an adequate number of wooden blocks so that it is above water and snow levels and has enough blocking to prevent it from settling into soft ground. Locate parts far enough apart to permit air circulation, sunlight, and space for periodic inspection. To minimize water accumulation, place all unit parts on blocking supports so that rain water will run off.

Do not cover parts with plastic film or tarps as these cause condensation of moisture from the air passing through heating and cooling cycles.

## Inspection and Maintenance during Storage

While in storage, inspect fans once per month. Keep a record of inspection and maintenance performed.

If moisture or dirt accumulations are found on parts, the source should be located and eliminated. At each inspection, rotate the fan wheel by hand ten to fifteen revolutions to distribute lubricant on motor. Every three months, the fan motor should be energized. If paint deterioration begins, consideration should be given to touch-up or repainting. Fans with special coatings may require special techniques for touch-up or repair.

Machined parts coated with rust preventive should be restored to good condition promptly if signs of rust occur. Immediately remove the original rust preventive coating with petroleum solvent and clean with lint-free cloths. Polish any remaining rust from surface with crocus cloth or fine emery paper and oil. Do not destroy the continuity of the surfaces. Wipe thoroughly clean with Tectyl® 506 (Ashland Inc.) or the equivalent. For hard to reach internal surfaces or for occasional use, consider using Tectyl® 511M Rust Preventive or WD-40® or the equivalent.

**REMOVING FROM STORAGE** — As units are removed from storage to be installed in their final location, they should be protected and maintained in a similar fashion, until the equipment goes into operation.

Prior to installing the unit and system components, inspect the unit assembly to make sure it is in working order.

1. Check all fasteners, set screws on the fan, wheel, bearings, drive, motor base, and accessories for tightness.
2. Rotate the fan wheel(s) by hand and assure no parts are rubbing.



# Table of Contents

## Installation

Clearance to Combustibles/Service Clearances . . . 3  
 Indoor Unit . . . . . 3  
 Unit Arrangement DB / HZ / UB . . . . . 4  
 Roof Mounted Unit — Arrangement DBC . . . . . 5-6  
 Optional Evaporative Cooler Module . . . . . 6  
 Electrical Wiring . . . . . 7  
 Direct Gas Piping . . . . . 8-9  
 Optional Evaporative Cooler Piping . . . . . 9-10  
 Optional Water Wizard™ . . . . . 11  
 Optional Direct Expansion (DX) Coil Piping . . . . 12-13  
 Optional Chilled Water Coil Piping . . . . . 13  
 Optional Building Pressure Control . . . . . 14  
 Optional Dirty Filter Switch . . . . . 14

## Start-Up

Blower . . . . . 15  
 Direct Gas . . . . . 16-18  
 Optional Evaporative Cooling Recirculating . . . . 19  
 Optional Water Wizard™ . . . . . 20-21

## Operation

Optional Water Wizard™ . . . . . 21  
 Optional VAV Units . . . . . 22  
 Optional Recirculating Units . . . . . 23  
 Electrical . . . . . 24

## Troubleshooting

Blower . . . . . 25  
 Motor Overamps . . . . . 26  
 Insufficient / Too Much Airflow . . . . . 27  
 Excessive Noise or Vibration . . . . . 28  
 Direct Gas Heater Does Not Operate . . . . . 29-30  
 Optional Evaporative Cooling . . . . . 31  
 Optional Water Wizard™ . . . . . 32

## Maintenance

Routine . . . . . 33-34  
 Fall . . . . . 35

## Reference

Gas Train Layout . . . . . 36  
 Control Center Layout . . . . . 37  
 Start-Up Check List . . . . . 38  
 Maintenance Log . . . . . 39

# Clearance to Combustibles / Service Clearances

	Floor	Top	Sides	Ends
Insulated/ Units	0 inches (0 mm)	0 inches (0 mm)	0 inches (0 mm)	0 inches (0 mm)
Non Insulated Units	0 inches (0 mm)	6 inches (152.4 mm)	6 inches (152.4 mm)	6 inches (152.4 mm)

Clearance to combustibles is defined as the minimum distance required between the heater and adjacent combustible surfaces to ensure the adjacent surface's temperature does not exceed 90 degrees above the ambient temperature.

Recommended Minimum Service Clearances	
Housing 32 and less	42 inches (1066.8 mm) on the controls side of the unit
Housing 35 and higher	48 inches (1219.2 mm) on the controls side of the unit

Clearances for component removal (such as evaporative cooler media) may be greater than the service clearances listed.

# Installation of Indoor Unit

## 1. Install Hangers

Install threaded hangers from ceiling supports. When locating hangers, allow enough room to open access panel(s). Two nuts must be used on the end of each threaded hanger. Ceiling supports are supplied by others.

## 2. Install Unit

Using sheet metal screws, attach the weatherhood/thru-wall/filter section to the blower/burner section. The flange on the weatherhood/thru-wall/filter section should overlap the flange on the blower/burner section.

Raise the assembled unit into place.

Using two nuts per hanger, fasten the unit supports to the hangers under the unit. Appropriate unit supports, such as the optional hanging bracket kit or c-channel and angle iron (supplied by others) should be used.

Using self-tapping screws, attach ductwork to unit.

In order to prevent the unit from swinging and to provide a safe environment for service and maintenance, additional measures must be taken to secure the unit in all directions.

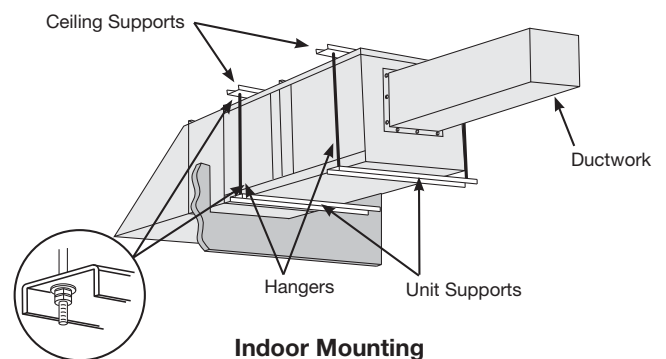

**Indoor Mounting**

### NOTE

Two nuts must be used on each end of each threaded hanging rod for proper support.

### NOTE

Good duct practices should be followed for all ductwork. Ductwork should be installed in accordance with SMACNA and AMCA guidelines, NFPA 96 and any local codes. Reference the CAPS submittal for duct sizes.

## 3. Seal Wall Opening

Apply sealant around the perimeter of the weatherhood to prevent water penetration and drafts into the building.

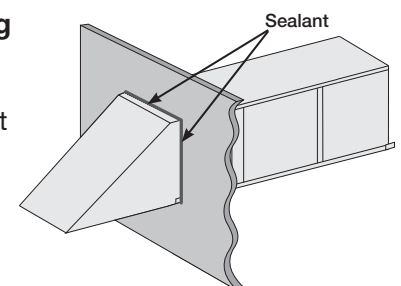

**Seal Wall Opening**



# Installation of Arrg. DB/HZ/UB

## 1. Install Curb and/or Equipment/Leg Support(s)

Position curb and/or equipment/leg support(s) on the roof (reference the CAPS submittal for placement in relation to the unit). Verify that unit supports are level, shim if necessary. Attach curb to roof and flash into place. Attach the equipment/leg support(s) to the roof, remove metal cover, flash to wooden nailer and reinstall cover.

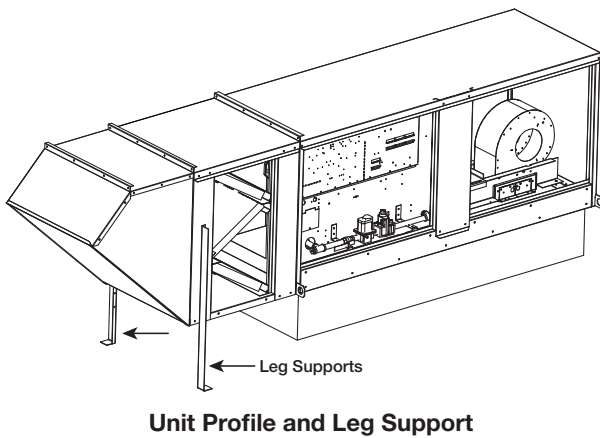
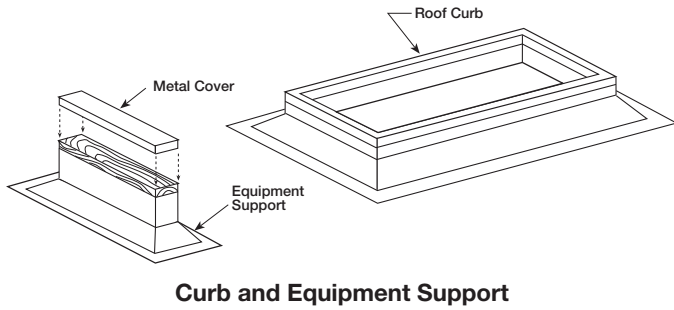

## 2. Install Ductwork

Good duct practices should be followed for all ductwork. All ductwork should be installed in accordance with SMACNA and AMCA guidelines, NFPA 96 and all local codes. Reference the CAPS submittal for ductwork sizes.

**NOTE**

The use of a duct adapter is recommended on a downblast (DB) arrangement to align the ductwork with the supply unit. The duct adapter is only a guide and is not to be used as a support for the ductwork.

## 3. Apply Sealant

Apply an appropriate sealant around the perimeter of the curb and duct adapter(s) to isolate fan vibration and prevent water penetration.

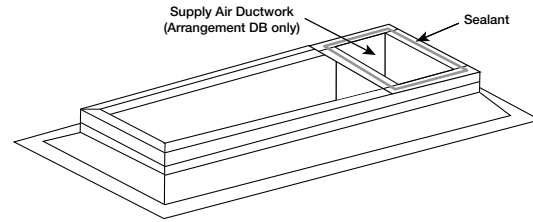

**Ductwork**

## 4. Install Unit

Use a crane and a set of spreader bars hooked to the factory lifting lugs to lift and center the unit on the curb/equipment support(s).

Use self-tapping sheet metal screws to fasten the unit to the curb/equipment support(s).

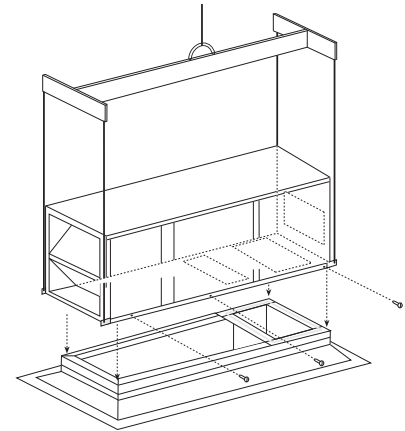

**Setting Unit**

**NOTE**

The use of all lifting lugs and a set of spreader bars is mandatory when lifting the unit.

**NOTE**

Some units come with the weatherhood attached and Step 5 may not apply.

## 5. Assemble and Attach Weatherhood

The weatherhood can now be assembled and attached to the unit. Detailed assembly instructions can be found with the weatherhood. If the optional evaporative cooling module was selected, this step does not apply, refer to the Installation of the Optional Evaporative Cooling Module section, page 6.

## 6. Seal Weatherhood Seam

Using an appropriate sealant, seal the seam between the weatherhood and the unit.

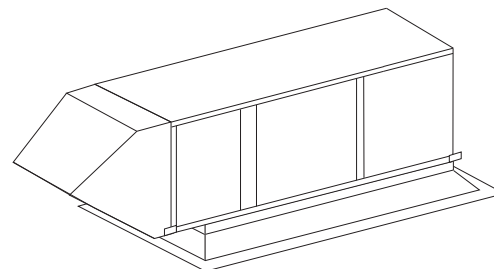

**Complete Rooftop Installation**





# Installation of Roof Mounted Unit Arrangement DBC

## 1. Install Curb/Equipment Support(s)

Position curb/equipment support(s) on the roof (reference the CAPS submittal for placement of curb/equipment support(s) in relation to the unit). Verify that all unit supports are level, shim if necessary. Attach curb to roof and flash into place. Attach the equipment support(s) to the roof, remove metal cover, flash to wooden nailer and reinstall cover.

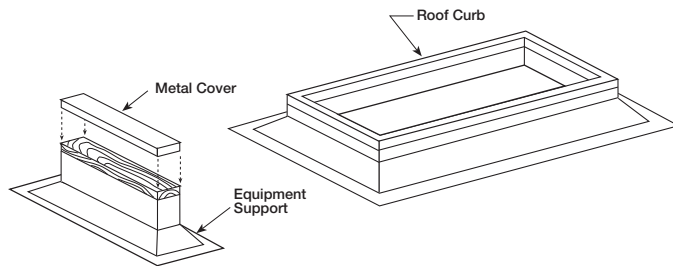

Curb and Equipment Support

## 2. Install Combination Curb Adaptor

Install combination curb adaptor over curb, use wood screws to lag in place. Locate extension so the tall louvered side is over the exhaust opening, as shown in illustration. Caulk extension to combination curb adaptor. Fasten extension to curb adaptor with #12 sheet metal screws (field-provided).

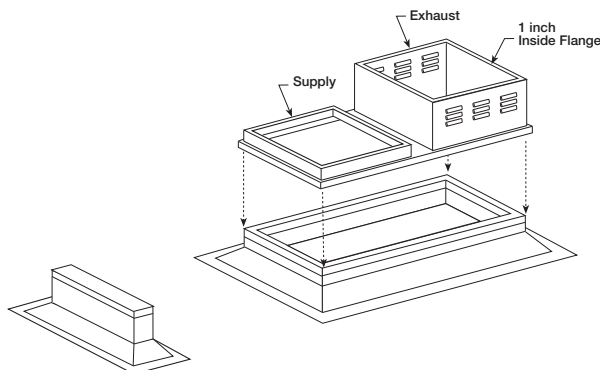

Combination Extension

## 3. Install Ductwork

Good duct practices should be followed for all ductwork. All ductwork should be installed in accordance with SMACNA and AMCA guidelines, NFPA 96 and any local codes. Reference the CAPS submittal for ductwork size and location.

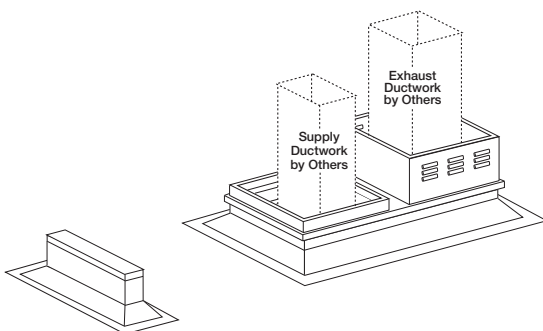

Ductwork

### NOTE

The use of a duct adapter is recommended on a downblast (DBC) arrangement to align the ductwork with the supply unit. The duct adapter is only a guide and is not to be used as a support for the ductwork.

## 4. Apply Sealant

Apply an appropriate sealant around the perimeter of the curb and duct adapter(s) to isolate fan vibration and prevent water penetration.

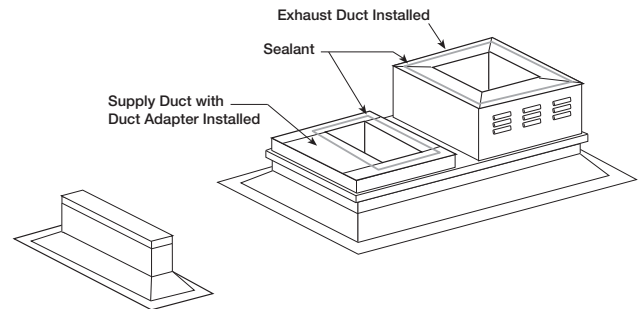

Sealing Ductwork

## 5. Install Exhaust Fan

Fasten exhaust fan to curb extension with self-tapping sheet metal screws. Installing the exhaust fan prior to the supply unit will allow for easier installation of options.

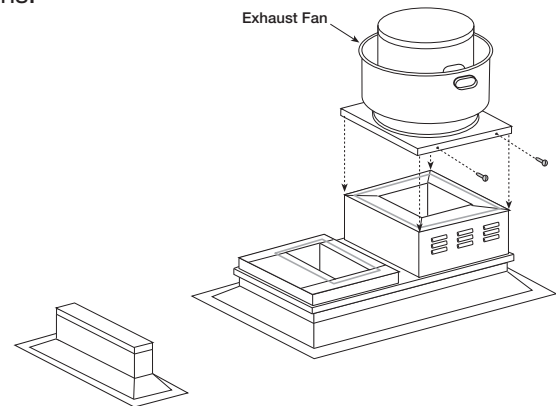

Installing Exhaust Fan

### NOTE

NFPA 96 requires the exhaust fan to be hinged.

## 6. Install Exhaust Options

Install optional hinge kit with restraining cables and grease trap with drain connection.



## 7. Install Supply Unit

Use a crane and a set of spreader bars hooked to the factory lifting lugs to lift and center the unit on the extension/equipment support(s).

Use self-tapping sheet metal screws to fasten the unit to the extension/equipment support(s).

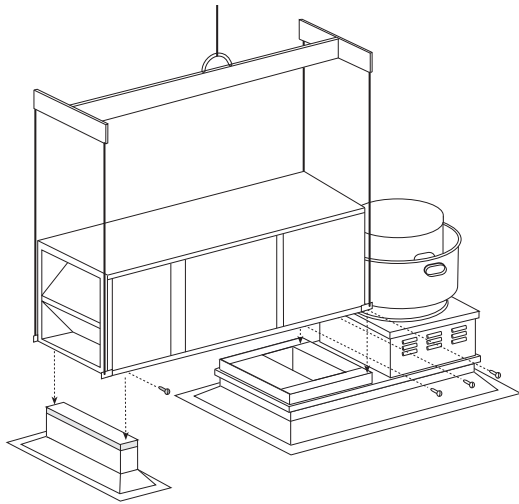

Installing Supply Unit

### NOTE

The use of all lifting lugs and a set of spreader bars is mandatory when lifting unit.

### NOTE

Some units come with the weatherhood attached and Step 8 may not apply.

## 8. Assemble and Attach Weatherhood

The weatherhood can now be assembled and/or attached to the unit. Detailed assembly instructions can be found with the weatherhood. If the optional evaporative cooling module was selected, this step does not apply, refer to the next section, Installation of the Optional Evaporative Cooling Module.

## 9. Seal Weatherhood Seam

Using an appropriate sealant, seal the seam between the weatherhood and the unit.

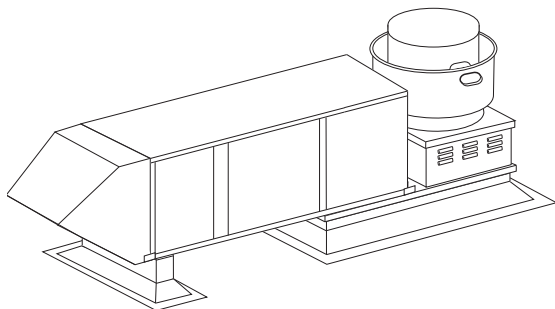

Complete Combination Installation

## Installation of Evaporative Cooling Module (optional)

### NOTE

Small evaporative coolers ship attached to the base unit and require no additional mounting.

### 1. Locate Equipment Support(s)

Position equipment support(s) on the roof (reference the CAPS submittal for placement of equipment support(s) in relation to the unit). Verify that all unit supports are level, shim if necessary. Attach equipment support to the roof, remove metal cover, flash to wooden nailer and reinstall cover.

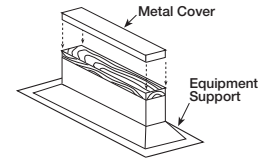

Equipment Support

### 2. Apply Sealant

Apply an appropriate sealant around the airstream opening to create an airtight seal.

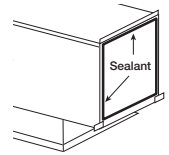

Sealant

### 3. Set Evaporative Cooling Module

Use a crane and a set of spreader bars hooked to the factory lifting lugs to lift and center the module on the equipment support(s). The

flange on the evaporative cooler should overlap the flange on the unit.

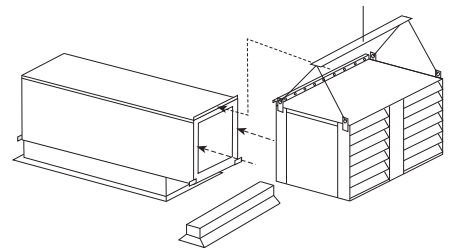

Placing Evaporative Module

### NOTE

The use of all lifting lugs and a set of spreader bars is mandatory when lifting the evaporative cooling module.

### 4. Secure Cooling Module to Unit

Use self-tapping screws to fasten the cooling module to the base unit along the top and down both sides. Fasten at the top through the flanges. To fasten the sides, the media must be removed. To remove the media, first remove the access panel on the evaporative module and disconnect the evaporative pump(s). The media will now slide out. With the media removed, you can access the side fastening points inside the evaporative module. With all the screws in place, reinstall the media, reconnect the pumps and reinstall the access panel.

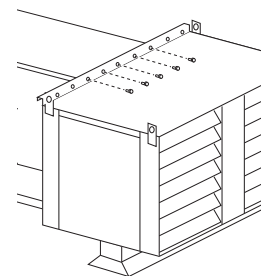

Securing Evaporative Module

### NOTE

When mounting the evaporative cooler, it is important that it is level to ensure proper operation and water drainage.



# Installation of Electrical Wiring

## IMPORTANT

Before connecting power to the unit, read and understand the following instructions and wiring diagrams. Complete wiring diagrams are attached on the inside of the control center door(s).

## IMPORTANT

All wiring should be done in accordance with the latest edition of the National Electric Code ANSI/NFPA 70 and any local codes that may apply. In Canada, wiring should be done in accordance with the Canadian Electrical Code.

## IMPORTANT

The equipment must be properly grounded. Any wiring running through the unit in the airstream must be protected by metal conduit, metal clad cable or raceways.

## CAUTION

If replacement wire is required, it must have a temperature rating of at least 105°C, except for an energy cut-off or sensor lead wire which must be rated to 150°C.

## DANGER

High voltage electrical input is needed for this equipment. This work should be performed by a qualified electrician.

## CAUTION

Any wiring deviations may result in personal injury or property damage. Manufacturer is not responsible for any damage to, or failure of the unit caused by incorrect final wiring.

## IMPORTANT

Manufacturer's standard control voltage is 24 VAC. Control wire resistance should not exceed 0.75 ohms (approximately 285 feet total length for 14 gauge wire; 455 feet total length for 12 gauge wire). If the resistance exceeds 0.75 ohms, an industrial-style plug-in relay should be wired in place of the remote switch. The relay must be rated for at least 5 amps and have a 24 VAC coil. Failure to comply with these guidelines may cause motor starters to chatter or not pull in, resulting in contactor failures and/or motor failures.

## 1. Determine the Size of the Main Power Lines

The unit's nameplate states the voltage and the unit's MCA. The main power lines to the unit should be sized accordingly. The nameplate is located on the outside of the unit on the control panel side.

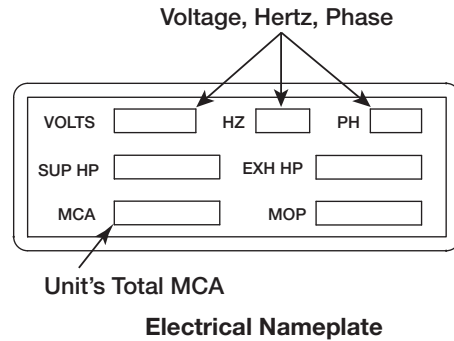

## 2. Provide the Opening(s) for the Electrical Connections

Electrical openings vary by unit size and arrangement and are field-supplied.

## 3. Connect the Main Power

Connect the main power lines to the disconnect switch and main grounding lug(s). Torque field connections to 20 in.-lbs.

## 4. Wire the Optional Convenience Outlet

The convenience outlet requires a separate 115V power supply circuit. The circuit must include short circuit protection which may need to be supplied by others.

## 5. Wire the Optional Accessories

Reference the Ladder Diagram on the inside of the control center door for correct wiring of the following accessories:

- Selectra Stat
- Room Override
- Blower Switch
- Heat Switch
- Indicating Lights
- Dirty Filter Indicator
- TSCP
- KSCP

## NOTE

Wiring to the Selectra Stat should be in separate conduit or run with shielded cable.

## NOTE

TSCP has number-to-number wiring.

## NOTE

Large evaporative coolers may require a separate power supply.

## 6. Wire the Optional Evaporative Cooler

Reference the Ladder Diagram on the inside of the control center door for correct wiring of the pump and the optional auto-drain and flush.



# Installation of Direct Gas Piping

## IMPORTANT

All gas piping must be installed in accordance with the latest edition of the National Fuel Gas Code ANSI/Z223.1 and any local codes that may apply. In Canada, the equipment shall be installed in accordance with the Installation Code for Gas Burning Appliances and Equipment (CGA B149) and Provincial Regulations for the class. Authorities having jurisdiction should be consulted before installations are made.

## WARNING

All components of this or any other gas-fired heating unit must be leak tested prior to placing the unit into operation. A soap and water solution should be used to perform this test. NEVER test for gas leaks with an open flame.

## WARNING

When leak testing pressures that are equal to 14 in. wc (3.5 kPa), first close the field-installed shutoff valve to isolate the unit from the gas supply line.

## WARNING

When leak testing pressures that are above 14 in. wc (3.5 kPa), close the field-installed shutoff valve, disconnect the furnace and gas train from the gas supply line and plug the supply line before testing.

## IMPORTANT

All piping should be clean and free of any foreign matter. Foreign material entering the gas train can damage the valves, regulators and burner.

## IMPORTANT

Do NOT connect the unit to gas types other than what is specified and do NOT connect the unit to gas pressures that are outside of the pressure range shown on the label.

## NOTE

When connecting the gas supply, the length of the run must be considered in determining the pipe size to avoid excessive pressure drop. Refer to a Gas Engineer's Handbook for gas pipe capacities.

## 1. Determine the Supply Gas Requirements

The unit's direct gas nameplate states the requirements for the gas being supplied to the unit. The direct gas nameplate is located on the outside of the unit on the control center side.

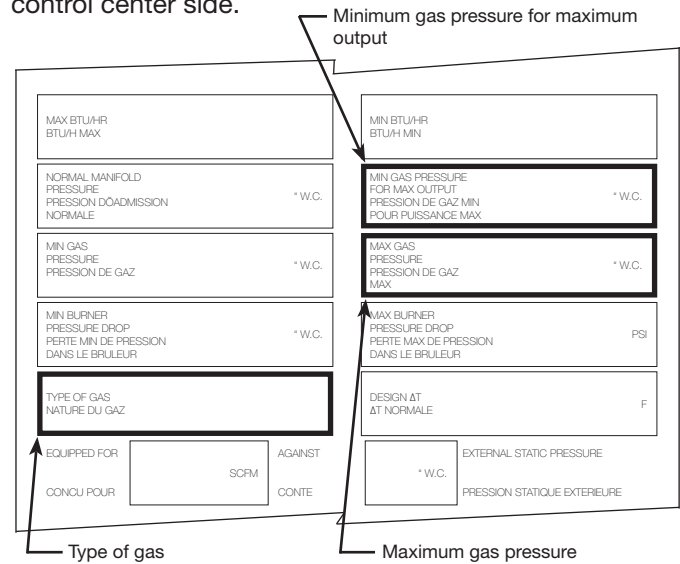

Direct Gas Nameplate

## 2. Install Additional Regulator if Required

When the supply gas pressure exceeds the maximum gas pressure shown on the direct gas nameplate, an additional regulator (by others) is required to reduce the pressure. The regulator must have a listed leak limiting device or it must be vented to the outdoors.

## NOTE

The regulator located inside the unit is used to adjust the unit's maximum output temperature.

## 3. Connect the Supply Gas Line

A manual shut off valve (gas cock), 1/8 in. plugged test port and 6 in. drip leg must be installed prior to the gas train. The valve and the test port must be accessible for the connection of a test gauge. Supply gas connections must be made by a qualified installer and are not furnished by manufacturer.

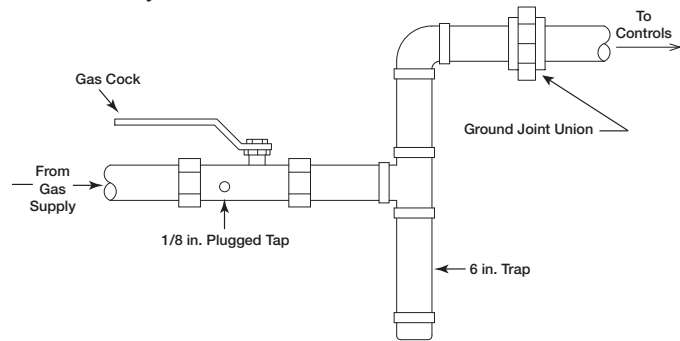

Supply Gas Line





#### 4. Pipe the Optional Vent Line

If an optional vent line is located between the safety shutoff valves, it must be piped to the outdoors.

#### WARNING

Reference the National Fuel Gas Code for additional vent line requirements.

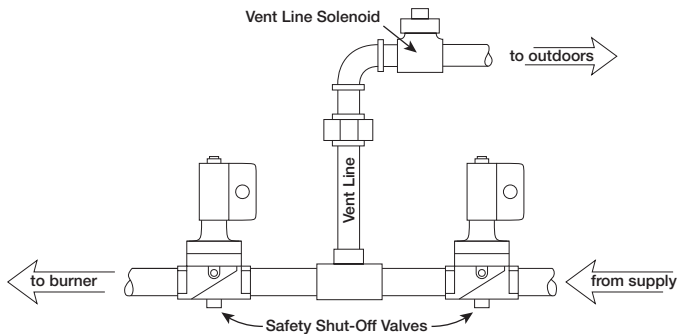

Optional Vent Line

#### 5. Test the System for Leaks

Check both the supply lines and the factory piping for leaks. Apply a soap and water solution to all piping and watch for bubbling which indicates a leak.

#### WARNING

NEVER test for a gas leak with an open flame.

#### NOTE

The factory piping has been checked for leaks, but should be rechecked due to shipping and installation.

## Installation Evaporative Cooler Piping (optional)

### Evaporative Cooling with Recirculating Pump

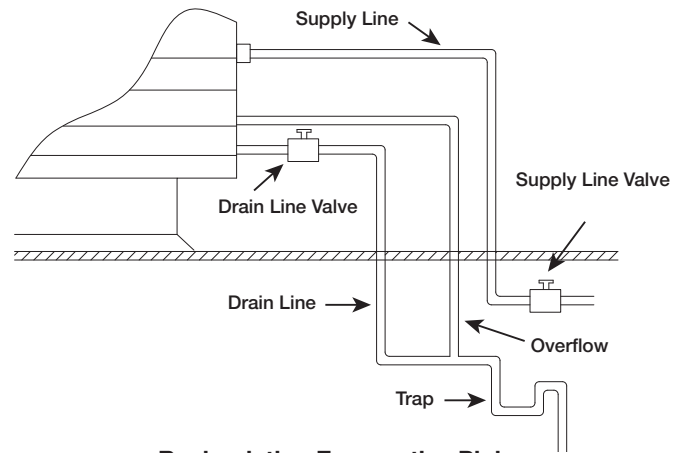

Recirculating Evaporative Piping

#### IMPORTANT

All supply solenoids, valves and all traps must be below the roof line or be otherwise protected from freezing.

#### IMPORTANT

The supply line should be of adequate size and pressure to resupply the amount of water lost due to bleed-off and evaporation. The drain line should be the same size or larger than the supply line.

#### CAUTION

Provisions must be taken to prevent damage to the evaporative cooling section during freezing conditions. The sump, drain lines and supply lines must be drained prior to freezing conditions or an alternate method must be used to protect the lines and media.

#### 1. Install the Water Supply Line

Supply line opening requirements vary by unit size and arrangement and are field-supplied. Connect the water supply line to the float valve through the supply line opening in the evaporative cooling unit. Install a manual shutoff valve in the supply line as shown above.

#### 2. Install the Drain Line

Connect an unobstructed drain line to the drain and overflow connections on the evaporative cooler. A manual shut off valve (by others) is required for the evaporative cooler drain line.

A trap should be used to prevent sewer gas from being drawn into the unit. Refer to drain trap diagram.

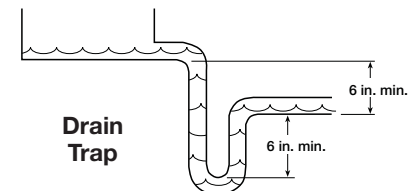

#### 3. Check/Adjust Water Level

Check the water level in the sump tank. The water level should be above the pump intake and below the overflow. Adjust the float as needed to achieve the proper water level.



# Installation Evaporative Cooler Piping (optional) continued

## Evaporative Cooling with Auto Drain and Fill

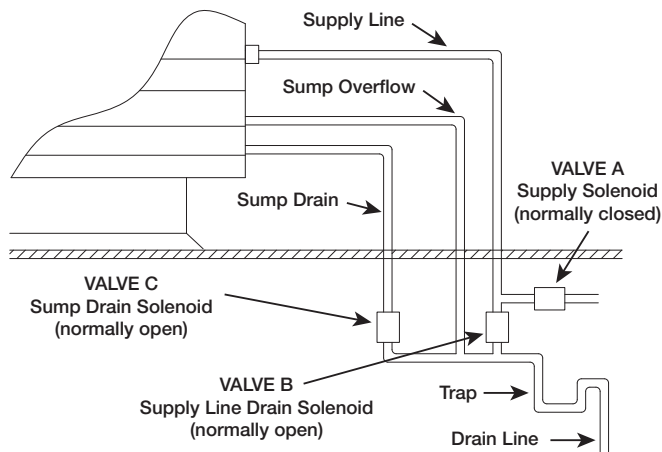

Auto Drain and Fill Evaporative Piping

### IMPORTANT

The supply line should be of adequate size and pressure to resupply the amount of water lost due to bleed-off and evaporation. The drain line should be the same size or larger than the supply line.

### CAUTION

All solenoid valves and traps must be installed below the roof to protect the supply water line from freezing. If they cannot be installed below the roof, an alternative method must be used to protect the lines from freezing.

### IMPORTANT

The supply solenoid (Valve A) is NOT the same as the drain solenoids (Valve B and Valve C). Make sure to use the proper solenoid for each location. Check your local code requirements for proper installation of this type of system.

Auto Drain & Flush Valves  
(when provided by manufacturer)

Assm. Number	Mfg. Part Number	ASCO Part Number	Solenoid Type	De-Energized Position	Diameter	Qty.
852178	461262	8210G2	Supply	Closed	1/2 inch (12.7 mm)	1
	461263	8262G262	Supply Line Drain	Open	1/4 inch (6.35 mm)	1
	461264	8210G35	Sump Drain	Open	3/4 inch (19.05 mm)	1

Part numbers subject to change.

### 1. Install the Water Supply Line

Supply line opening requirements vary by unit size and arrangement and are field-supplied. Connect the water supply line to the float valve through the supply line opening in the evaporative cooling unit. Install the 1/2 in. normally closed solenoid (Valve A) in the supply line. Install the 1/4 in. normally open solenoid (Valve B) between the supply line and the drain line. Refer to Auto Drain and Fill Evaporative Piping drawing shown on this page.

### 2. Install the Drain Line

Connect an unobstructed drain line to the sump drain overflow connection. Install the 3/4 in. normally open solenoid (Valve C) between the sump drain connection and the drain line.

A trap should be used to prevent sewer gas from being drawn into the unit. Refer to drain trap drawing.

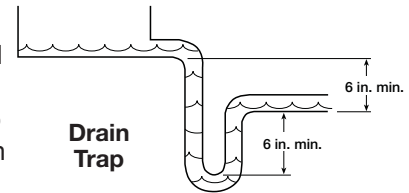

### 3. Check/Adjust Water Level

Check the water level in the sump tank. The water level should be above the pump intake and below the overflow. Adjust the float as needed to achieve the proper water level.



# Installation of Water Wizard™ (optional)

## Evaporative Cooling with the Water Wizard™

### NOTE

The following instructions are provided for evaporative coolers equipped with the Water Wizard™ only. Additional instructions are provided for evaporative coolers equipped with the auto-drain and fill or bleed-off.

### WARNING

Disconnect and lock-out all power and gas before performing any maintenance or service to the unit. Failure to do so could result in serious injury or death and damage to equipment.

### Water Wizard™ Valves (when provided by manufacturer)

Unit Model	Assm. Number	Mfg. Part Number	ASCO Part Number	Solenoid Type	De-Energized Position	Diameter	Qty.
XDG-H10/H20	852370	461262	8210G2	Supply	Closed	1/2 inch (12.7 mm)	1
XDGX-H12/H22		383086	8210G34	Supply Line Drain	Open	1/2 inch (12.7 mm)	1
XDGX-H32 (<9000 cfm)	852371	383088	8210G9	Supply	Closed	3/4 inch (19.05 mm)	1
XDGX-H30		383086	8210G34	Supply Line Drain	Open	1/2 inch (12.7 mm)	1
XDGX-H32 (≥9000 cfm)							
XDGX-H35, H38, H42							

Part numbers subject to change.

### 1. Install Normally Closed Supply Line/Solenoid

Connect the water supply line to the manual supply valve in the unit. Install the supply solenoid in the supply line, upstream of the manual supply valve and below the roof line.

### 2. Install Normally Open Drain Line/Solenoid

Connect the drain line to the supply line between the manual supply valve and the supply solenoid. Install a drain solenoid in the drain line, below the roof line. A trap should be installed in the drain line.

### NOTE

Solenoid(s) may be provided by manufacturer (if ordered) or by others.

### CAUTION

Any wiring deviations may result in personal injury or property damage. Manufacturer is not responsible for any damage to, or failure of the unit caused by incorrect final wiring.

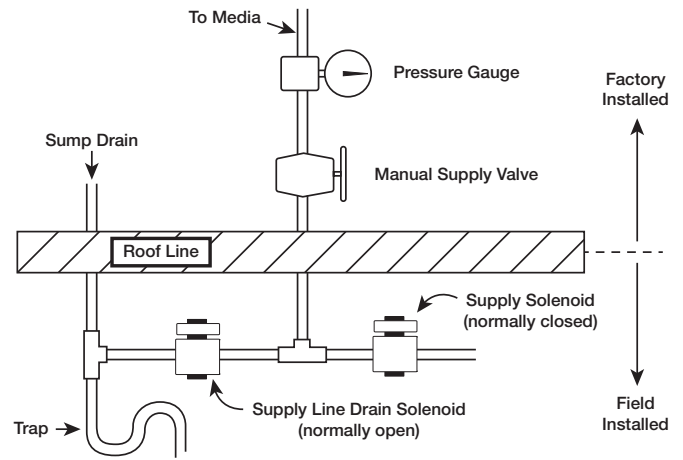

Water Wizard™ Installation

### 3. Wire the Solenoid(s)

Wire the supply line solenoid and drain solenoid as shown on the unit's wiring diagram in the control center.

### 4. Wire the Temperature Sensor

If the evaporative cooler shipped separate from the unit, the temperature sensor must be wired. The sensor wire is bundled inside the discharge end of the evaporative cooler. Wire the sensor wire to terminals AI2 and AIC on the terminal strip in the unit's control center.

### NOTE

The Water Wizard™ start-up must be completed for proper performance.



# Installation of Direct Expansion (DX) Coil Piping (optional)

## IMPORTANT

Guidelines for the installation of direct expansion cooling coils have been provided to ensure proper performance and longevity of the coils. These are general guidelines that may have to be tailored to meet the specific requirements of any one job. As always, a qualified party or individual should perform the installation and maintenance of any coil. Protective equipment such as safety glasses, steel toe boots and gloves are recommended during the installation and maintenance of the coil.

## IMPORTANT

All field-brazing and welding should be performed using high quality materials and an inert gas purge (such as nitrogen) to reduce oxidation of the internal surface of the coil.

## IMPORTANT

All field-piping must be self-supporting and flexible enough to allow for the thermal expansion of the coil.

### 1. Locate the Distributor(s) by Removing the Distributor Access Panel



Distributor Access Panel

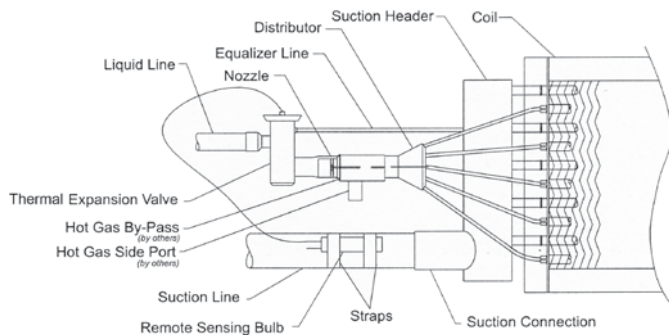

Installation with Hot Gas Bypass

### 2. Verify Nozzle Placement

Inspect the refrigerant distributor and verify that the nozzle is in place. The nozzle is generally held in place by a retaining ring or is an integral part of the distributor itself.

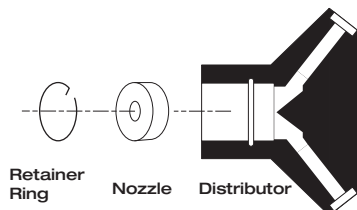

## NOTE

If a hot gas bypass kit was provided by others, refer to the manufacturer's instructions.

### 3. Install Suction Line

Install suction line(s) from the compressor to the suction connection(s) which are stubbed through the side of the cabinet.

### 4. Install the Liquid Line and Thermal Expansion Valve (TEV) (by others)

Liquid line openings vary by coil size and circuiting and are field-supplied. Follow the TEV recommendations for installation to avoid damaging the valve. If the valve is externally equalized, use a tubing cutter to cut off the plugged end of the factory installed equalizer line. Use a de-burring tool to remove any loose metal from the equalizer line and attach it to the TEV. If the valve is internally equalized, the factory-installed equalizer line can be left as is.

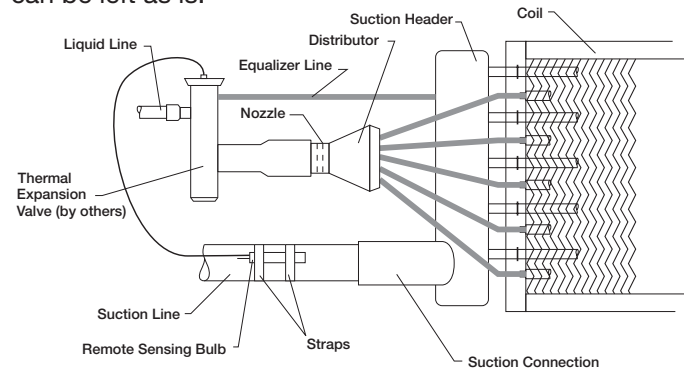

General Installation

### 5. Mount the Remote Sensing Bulb (by others)

The expansion valve's remote sensing bulb should be securely strapped to the horizontal run of the suction line at the 3 or 9 o'clock position and insulated.

### 6. Check Coil Piping for Leaks

Pressurize the coil to 100 psig with dry nitrogen or other suitable gas. The coil should be left pressurized for a minimum of 10 minutes. If the coil holds the pressure, the hook-up can be considered leak free. If the pressure drops by 5 psig or less, re-pressurize the coil and wait another 10 minutes. If the pressure drops again, there is likely one or more small leaks which should be located and repaired. Pressure losses greater than 5 psig indicate a large leak that should be isolated and repaired.



## 7. Evacuate and Charge the Coil

Use a vacuum pump to evacuate the coil and any interconnecting piping that has been open to the atmosphere. Measure the vacuum in the piping using a micron gauge located as far from the pump as possible. Evacuate the coil to 500 microns or less, and then close the valve between the pump and the system. If the vacuum holds to 500 microns or less for one minute, the system is ready to be charged or refrigerant in another portion of the system can be opened to the coil.

A steady rise in microns would indicate that moisture is still present and that the coil should be further vacuumed until the moisture has been removed.

### NOTE

Failure to obtain a high vacuum indicates a great deal of moisture or a small leak. Break the vacuum with a charge of dry nitrogen or other suitable gas and recheck for leaks. If no leaks are found, continue vacuuming the coil until the desired vacuum is reached.

## 8. Install the Drain Line

Connect an unobstructed drain line to the drain pan. A trap should be used to prevent sewer gas from being drawn into the unit.

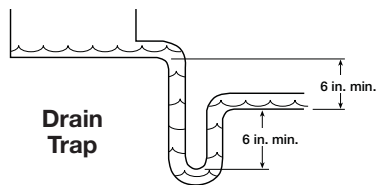

### IMPORTANT

All traps must be installed below the roof line or be otherwise protected from freezing.

## Installation of Chilled Water Coil Piping (optional)

### IMPORTANT

Guidelines for the installation of the cooling coil have been provided to ensure proper performance of the coils and their longevity. These are general guidelines that may have to be tailored to meet the specific requirements of any one job. As always, a qualified party or individual should perform the installation and maintenance of the coil. Protective equipment such as safety glasses, steel toe boots and gloves are recommended during the installation and maintenance of the coil.

When installing couplings, do not apply undue stress to the connection. Use a backup pipe wrench to avoid breaking the weld between the coil connection and the header.

All field-piping must be self-supporting. System piping should be flexible enough to allow for the thermal expansion and contraction of the coil.

### 1. Verify Coil Hand Designation

Check the coil hand designation to ensure that it matches the system. Coils are generally plumbed with the supply connection located on the bottom of the leaving air-side of the coil and the return connection at the top of the entering air-side of the coil. This arrangement provides a counter flow heat exchanger and positive coil drainage.

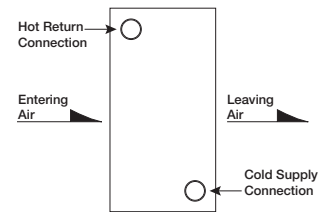

### 2. Check the Coil for Leaks

Pressurize the coil to 100 psig with dry nitrogen or other suitable gas. The coil should be left pressurized for a minimum of 10 minutes. If the coil holds the pressure, the hook-up can be considered leak free. If the pressure drops by 5 psig or less, re-pressurize the coil and wait another 10 minutes. If the pressure drops again, there is likely one or more small leaks which should be located and repaired. Pressure losses greater than 5 psig indicate a large leak that should be isolated and repaired.

### 3. Connect the Supply & Return Lines

Connect the supply and return lines as shown above.

### 4. Install the Drain Line

Connect an unobstructed drain line to the drain pan. A trap should be installed to prevent sewer gas from being drawn into the unit.

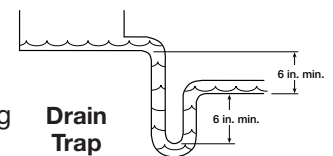

### IMPORTANT

All traps must be installed below the roof line or be otherwise protected from freezing.





## Installation of Building Pressure Control *(optional)*

### 1. Mount Pressure Tap

Using the factory provided bracket, mount the pressure tap to the outside of the unit. Choose a location out of the prevailing winds and away from supply or exhaust fans to assure accurate readings.



### 2. Run Pressure Tap Lines

Run a pressure tap line from the pressure tap on the outside of the unit to the low pressure tap on the back of the photohelic gauge. Run a second pressure tap line from the high pressure tap on the back of the photohelic gauge to the space. Fifty feet of tubing is supplied with the unit.

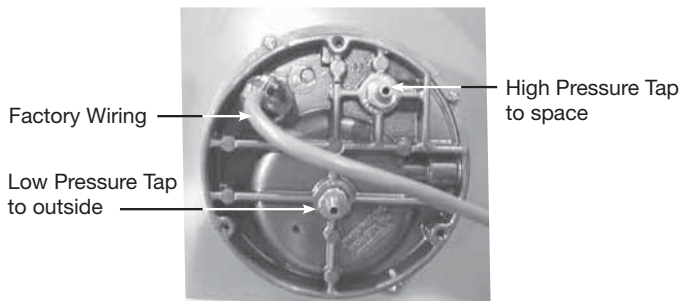

Connections for Photohelic Gauge

### 3. Set the Building Pressure

The pressure gauge is used to set the desired building pressure.

The pressure is set by adjusting the knobs for the upper and lower pressure limits. Typical settings are 0.0 inch wc for the lower and 0.10 inch wc for the upper pressure setting.

Pressure Indicating Needle      Pressure Setting Needles

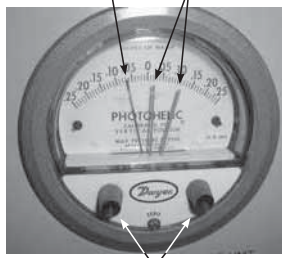

Pressure Setting Knobs

Typical Photohelic Gauge

## Installation of Dirty Filter Switch *(optional)*

To adjust the switch, the unit must be running with all of the access doors in place, except for the compartment where the switch is located (exhaust intake compartment). The adjusting screw is located on the top of the switch.

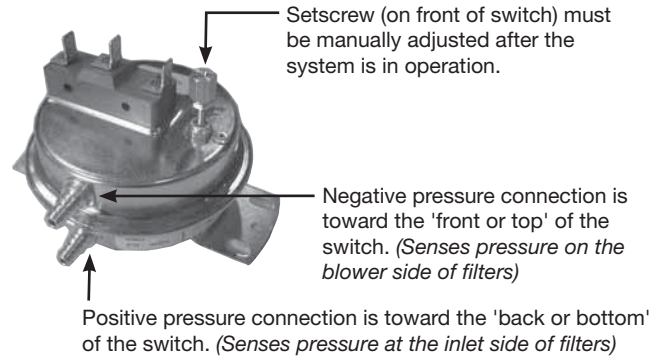

1. Open the filter compartment and place a sheet of plastic or cardboard over 50% of the filter media.
2. Replace the filter compartment door.
3. Check to see if there is power at the alert signal leads (refer to electrical diagram).
4. Whether there is power or not, turn the adjustment screw on the dirty filter gauge - clockwise if you did not have power, counterclockwise if you did have power - until the power comes on or just before the power goes off.
5. Open the filter compartment and remove the obstructing material.
6. Replace the door and check to make sure that you do not have power at the alert signal leads. The unit is now ready for operation.



## Start-Up - Blower

**Refer to the Start-Up Checklist in the Reference section before proceeding further!**

### Pre Start-Up Check

Rotate the fan wheel by hand and make sure no parts are rubbing. Check the V-belt drive for proper alignment and tension (a guide for proper belt tension and alignment is provided in the Belt Maintenance section). Check fasteners, set screws and locking collars on the fan, bearings, drive, motor base, and accessories for tightness.

#### WARNING

Disconnect and lock-out all power and gas before performing any maintenance or service to the unit. Failure to do so could result in serious injury or death and damage to equipment.

#### SPECIAL TOOLS REQUIRED

- Voltage Meter (with wire probes)
- Amperage Meter
- Pressure Gauges – (refrigerant)
- Tachometer
- Thermometer
- U-tube manometer or equivalent

#### WARNING

Check the housing, blower, and ductwork for any foreign objects before running the blower.

### 1. Check the Voltage

Before starting the unit, compare the supplied voltage, hertz, and phase with the unit and motor's nameplate information.

### 2. Check the Blower Rotation

Open the blower access door and run the blower momentarily to determine the rotation.

Arrows are placed on the blower scroll to indicate the proper direction or reference the example shown to the right.

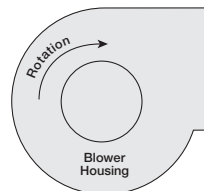

Blower Rotation

#### NOTE

To reverse the rotation on three phase units, disconnect and lock-out the power, then interchange any two power leads.

#### NOTE

To reverse the rotation on single phase units, disconnect and lock-out the power, then rewire the motor per the manufacturer's instructions.

#### IMPORTANT

If the blower is rotating in the wrong direction, the unit will move some air, but will not perform as designed. Be sure to perform a visual inspection to guarantee the correct blower rotation.

### 3. Check for Vibration

Check for unusual noise, vibration or overheating of the bearings. Reference the Troubleshooting section for corrective actions.

#### IMPORTANT

Excessive vibration may be experienced during the initial start-up. Left unchecked, it can cause a multitude of problems including structural and/or component failure.

#### IMPORTANT

Generally, fan vibration and noise is transmitted to other parts of the building by the ductwork. To minimize this undesirable effect, the use of heavy canvas duct connectors is recommended.

### 4. Motor Check

Measure the motor's voltage, amps and RPM. Compare to the specifications. Motor amps can be reduced by lowering the motor RPM or increasing system static pressure.

#### IMPORTANT

Additional starters and overloads may be provided in the make-up air control center for optional exhaust blowers. Any additional overloads must be checked for proper voltage, amps and RPMs.

### 5. Air Volume Measurement and Check

Measure the unit's air volume (cfm) and compare it with it's rated air volume. If the measured air volume is off, adjust the fan's RPM by changing/adjusting the drive.

#### NOTE

The most accurate way to measure the air volume is by using a pitot traverse method downstream of the blower. Other methods can be used but should be proven and accurate.

#### IMPORTANT

Changing the air volume can significantly increase the motor's amps. If the air volume is changed, the motor's amps must be checked to prevent overloading the motor.

#### NOTE

To ensure accuracy, the dampers are to be open when measuring the air volume.

### 6. Set-Up Optional Components

Adjust the settings on the optional components. See the Control Center Layout in the Reference section for location of optional components.

- Heating Inlet Air Sensor  
Typical setting: 60-70°F
- Cooling Inlet Air Sensor  
Typical setting: 75°F
- Building Freeze Protection  
Typical setting: 5 minutes; 45°F
- Dirty Filter Gauge  
Typical setting: Settings vary greatly for each unit.



# Start-Up - Direct Gas

## IMPORTANT

For proper unit function and safety, follow the start-up procedure in the exact order that it is presented.

## IMPORTANT

This start-up should begin after all of the installation procedures and the blower start-up have been completed.

### 1. Check the Supply Gas Pressure

Check the supply gas pressure and compare it with the unit's nameplate pressure requirements. Adjust the supply regulator as needed until the supply gas pressure is within the specified range (see below). The nameplate is located on the outside of the unit on the control panel side.

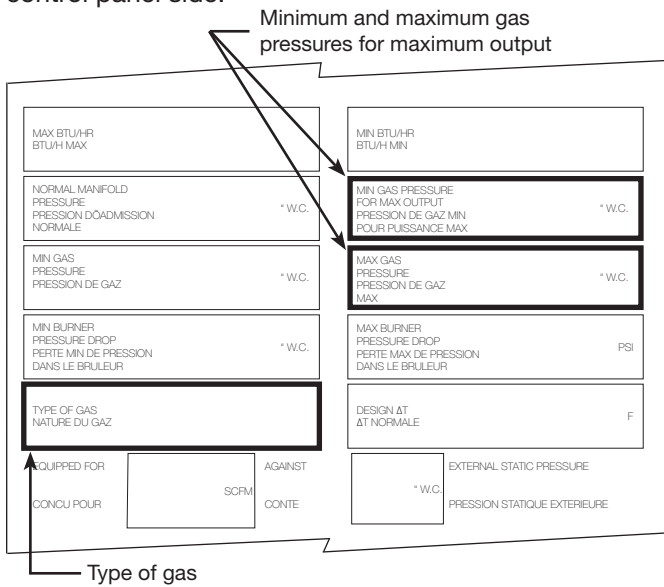

Direct Gas Nameplate

### 2. Check the Optional High and Low Gas Pressure Switches

The high pressure setting is typically 8 in. wg (2 kPa) and the low pressure is setting is typically 3 in. wg (0.7 kPa). The switches are set at the factory and should not need adjustment. Adjust the setting only if needed. See the Gas Train Layout diagram in the Reference section for the high and low pressure switch location.

## IMPORTANT

The purpose of the high and low gas pressure switches is to automatically shut down the burner if the inlet gas pressure is too low for the burner to safely light, or if the manifold pressure is too high for the burner to operate properly.

## IMPORTANT

Proper air velocity over the burner is critical on direct fired gas units. If the air velocity is not within the unit specifications, the unit will not operate efficiently, may have sporadic shutdowns, and may produce excessive carbon monoxide (CO) or other gases.

### 3. Set the Burner Air Pressure Differential

With all access panels in place, the fan running and discharging 70°F (21°C) air, connect a U-Tube manometer to the outer sensing probes (see below) and measure the static pressure across the burner.

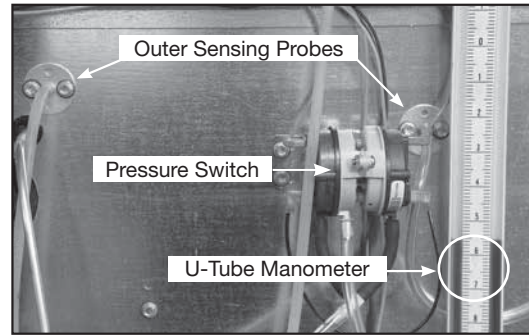

Measuring the Pressure Drop

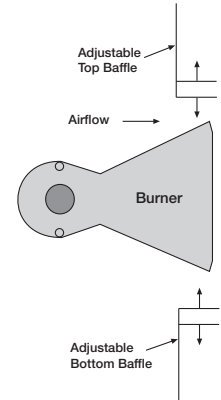
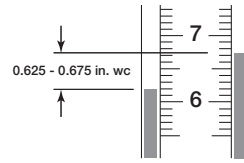

The proper static pressure should be between 0.625 and 0.675 inches wg (155.68 and 168.64 Pa). If needed, evenly adjust the baffles above and below the burner, keeping the burner centered in the opening until the required pressure is obtained.

Burner and Baffles

## NOTE

The pressure drop was set at the factory and may not need adjustment.

## NOTE

When required pressure is obtained, be sure to reconnect the outer sensing probes.

## IMPORTANT

This process may need to be repeated until the proper pressure is achieved. This adjustment will change the air quantity delivered by the unit and therefore the air quantity delivered should be rechecked. Refer to the Blower Start-Up section.

## NOTE

To increase the static pressure decrease the opening. To decrease the static pressure increase the opening.



#### 4. Set the Low Fire Time Delay

Set the low fire time delay to 75% of its maximum setting. See below for the location of the time delay setting.

#### NOTE

The low fire time delay must be set high enough to provide at least 10 seconds of low fire while the unit tries to light.

#### 5. Set the Maximum Firing Rate

Monitor the unit's actual temperature rise by placing a thermocouple in the unit's inlet and a second in the discharge, three duct diameters downstream of the burner.

Send the unit to maximum fire by disconnecting and isolating the wire connected to Terminal 3 on the Maxitrol 14 or the Maxitrol 44. See images on next page.

While monitoring the unit's temperature rise, set the maximum firing rate by adjusting the regulator until the designed temperature rise is achieved. After setting the maximum firing rate, reconnect the wire to the amplifier.

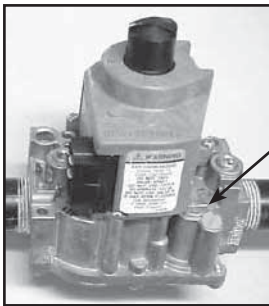

Maximum firing rate adjustment

Combined Regulator Valve

#### NOTE

Do not set the burner maximum firing rate based on gas pressure. It should be set based on the unit's designed temperature rise shown on the direct gas label.

MAX BTU/HR BTU/H MAX	MIN BTU/HR BTU/H MIN
NORMAL MANIFOLD PRESSURE PRESSION D'ADMISSION NORMALE * W.C.	MIN GAS PRESSURE FOR MAX OUTPUT PRESSION DE GAZ MIN POUR PUISSANCE MAX * W.C.
MIN GAS PRESSURE PRESSION DE GAZ * W.C.	MAX GAS PRESSURE PRESSION DE GAZ MAX * W.C.
MIN BURNER PRESSURE DROP PERTE MIN DE PRESSION DANS LE BRULEUR * W.C.	MAX BURNER PRESSURE DROP PERTE MAX DE PRESSION DANS LE BRULEUR PSI
TYPE OF GAS NATURE DU GAZ	DESIGN AT &T NORMALE F
EQUIPPED FOR CONQU POUR	AGAINST CONTE
SCFM	* W.C. EXTERNAL STATIC PRESSURE PRESSION STATIQUE EXTERIEURE

Direct Gas Nameplate

#### IMPORTANT

Setting the maximum firing rate during mild weather conditions may cause the high limit to trip out during extreme conditions requiring manual resetting.

#### NOTE

Gas trains are equipped with a combined regulator valve.

#### NOTE

Clockwise rotation increases the temperature rise, counterclockwise rotation decreases the temperature rise.

#### NOTE

The minimum setting for the maximum firing rate may be higher than required. This is acceptable, the burner will modulate as needed.

#### 6. Set the Minimum Firing Rate

Disconnect and isolate one of the wires running to the modulating valve to send the unit to its minimum firing rate. Set the minimum firing rate by adjusting the needle valve.

Remove one wire to send the unit to the minimum firing rate.



Minimum firing rate adjustment

Modulating Valve

After setting the minimum firing rate, reconnect the wire to the modulating valve.

#### IMPORTANT

The proper minimum firing rate setting results in a small ribbon of continuous flame which covers the flame rod and runs across the entire burner.

#### IMPORTANT

The minimum firing rate setting is critical. If the settings is too high, the unit may not light, too low and the flame rod may not detect the flame.

#### IMPORTANT

Do not allow the disconnected wire to come in contact with a potential ground. Damage to the amplifier or transformer could result.

#### NOTE

Adjusting the maximum and minimum fire may require the inlet air sensor to be initially set higher than desired in order to start the burner(s). Once high and low fire have been set, the inlet air sensor should be turned down to the desired temperature.

#### NOTE

Counterclockwise rotation increases the minimum fire rate setting, clockwise rotation decreases the setting.





## 7. Set the Unit's Operating Temperature

Set the operating temperature. The operating temperature setting depends on which Maxitrol controller is used.

**Maxitrol Series 14** - The Maxitrol Series 14 should be set to the desired discharge temperature mode. Place dipswitch in the "UP" position for local control and in the "DOWN" position for remote control. Keep LFST dipswitch in the "UP" position at all times for 10 second delay. **Fig. A** is required for remote control.

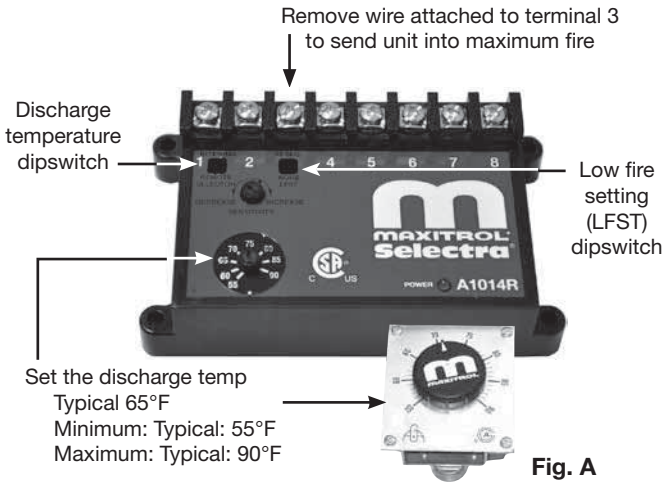

**Maxitrol Series 14 — 8 terminals**

**Maxitrol Series 44** - The Maxitrol Series 44 should be set to the desired space temperature. The temperature selector is a stand-alone dial. The stand-alone dial may be mounted remotely.

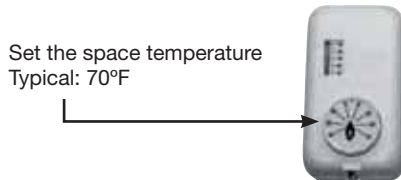

**Series 44 Temperature Setting  
(shown as Space Temperature Control)**

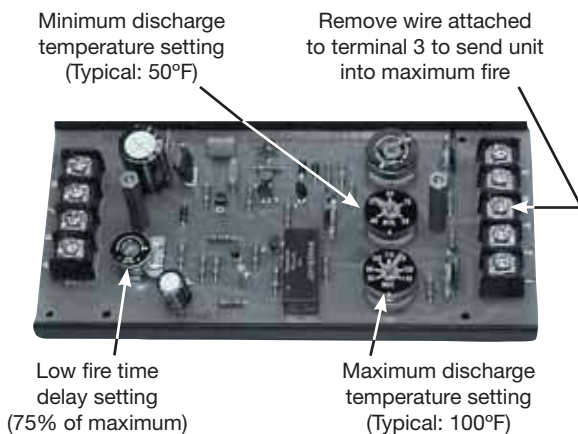

**Maxitrol Series 44 — 9 terminals**

**Maxitrol SC25S** - The SC25S is an analog signal converter that will change a 0-10 VDC or a 4-20 mA control signal provided by an owner-supplied Building Management System into an output level capable of driving one or more modulating gas valves.

The SC25S also limits the minimum and maximum discharge air temperatures. Reference the unit-specific wiring diagram and Maxitrol data sheets included in the IOM packet.

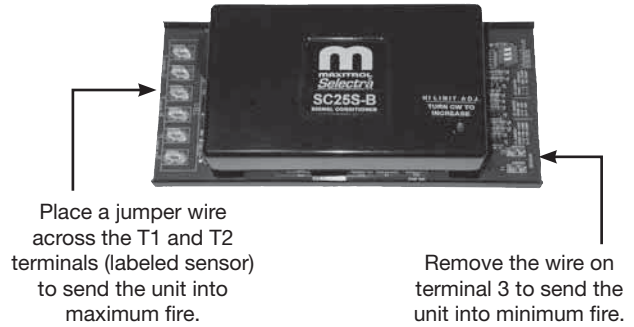

## 8. Flame Signal Check

To measure the flame signal, disconnect the flame sensor wire from Sense terminal on ignition controller. Connect one multimeter lead to the flame sensor wire and one to the Sense terminal (series). Set multimeter range to micro amps. The flame signal should be between .15 to .3 micro amps.

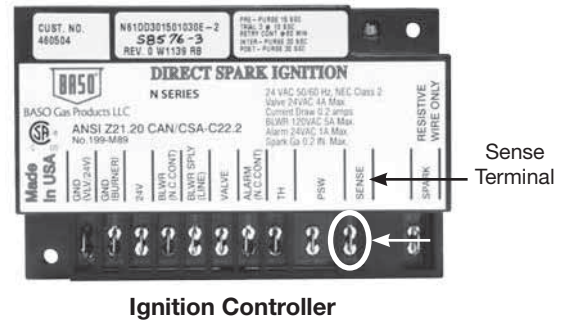



# Start-Up - Evaporative Cooling Recirculating (optional)

## 1. Check the Installation

The media may have been removed during installation, so its orientation should be double checked. The media should be installed with the steeper flute angle sloping down towards the entering air side.

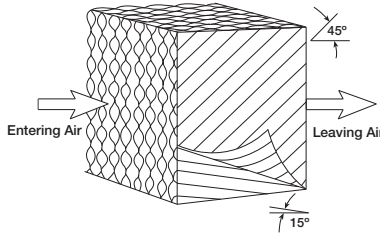

Media Orientation

Verify that the stainless steel caps and distribution headers are in place. The headers should be located over the media towards the entering air side. The caps should be placed over the headers.

## 2. Check the Pump Filter

Check that the pump filter is around the pump inlet.

## 3. Fill the Sump and Adjust the Float

Turn on the water supply and allow the sump tank to fill. Adjust the float valve to shut-off the water supply when the sump is filled to within 1 inch of the bottom of the overflow.

## 4. Break-In the Media

Open the bleed-off valve completely and saturate the media with the blower(s) off for no less than 20 minutes.

### NOTE

A jumper will need to be installed in the control center to power the evaporative pumps with the blower(s) off. Reference the unit's ladder diagram to determine proper terminals.

## 5. Check the Flow Rate

The pumps should provide enough water to saturate the media in 45 to 60 seconds. Consult the factory, if adequate flow is not achieved.



Manual Ball Valve

### NOTE

If too much water is flowing to the media, the flow can be adjusted using the manual ball valve. If flow adjustments are made, verify that sufficient water is still being supplied to the media to keep the entire pad wet during normal operation. Too high of a water flow can cause water carryover problems.

## 6. Adjust the Water Bleed-Off Rate

The water bleed-off rate is dependent on the water's mineral content. The bleed-off should be adjusted based on the media's mineral deposits after two weeks of service.

## 7. Set the Optional Auto Drain and Fill

This system will automatically drain the sump tank and fill it with fresh water at the field-adjustable intervals, typically once every 24 hours. This flushes mineral build-up and debris from the tank to promote low maintenance and increase media pad life.

In addition, the system will protect the evaporative cooler from freezing by draining the sump tank and supply line when the outside temperatures fall below the set point of the outside air sensor. This is set to 45°F and is not adjustable. The auto drain and fill outdoor air sensor should be installed in an area that is shaded from direct sunlight so the outside air sensor probe will detect an accurate air temperature.

### Set the Timer Scale and Settings dials:

- **T1** timer setting set to **10** and timer scale set to **1d** for 1 day of operation
- **T2** timer setting set to **10** and the timer scale set to **10m** for 10 minutes of drain time

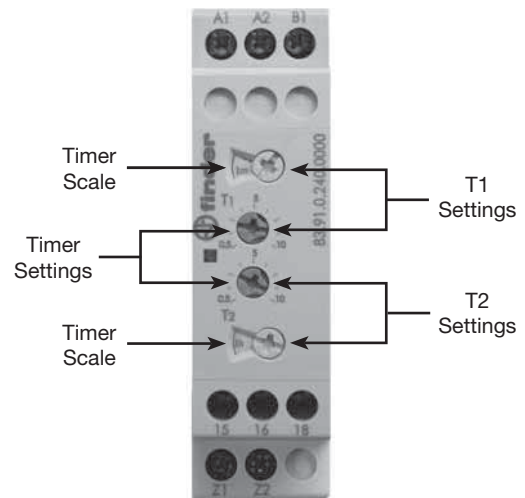

Auto Drain and Flush Timer

## 8. Put the Unit into Service

Remove the jumper and energize the blower(s). Verify proper operation.

### IMPORTANT

Check the media for minerals after two weeks of service and adjust the bleed-off rate accordingly.

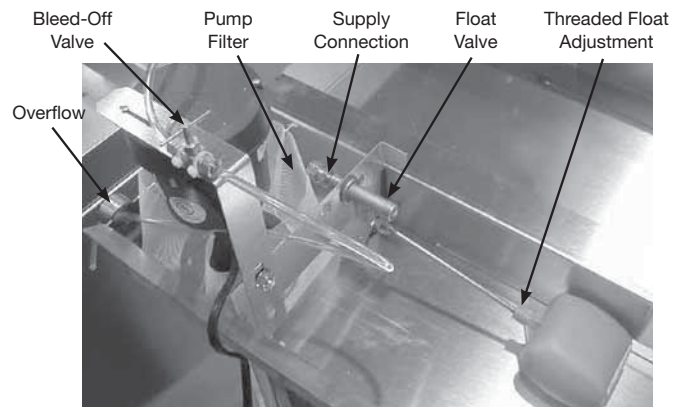

Evaporative Cooler Set-Up



## Start-Up - Water Wizard™ (optional)

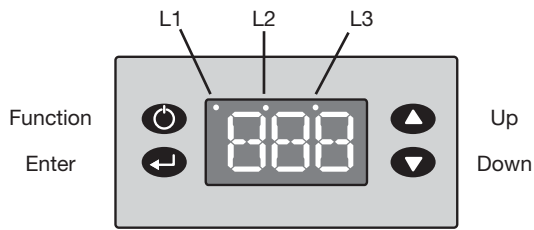

Water Wizard™ User Interface  
Key Function Description

### 1. Open the Solenoid

Confirm that the manual water supply valve is closed. Press and hold the Function key for one second. L3 will begin blinking (short on, long off), indicating that Flow Test Mode is active and the supply solenoid is open.

### 2. Set the Water Pressure

With the solenoid open, set the supply water pressure to the correct setting from the following tables. Use the manual supply valve to adjust the supply pressure. A pressure gauge is provided between the manual supply valve and the media.

#### WARNING

Opening the manual supply valve will allow water to pass to the media. Be sure the sump is safely draining before opening the manual supply valve.

#### NOTE

The manual supply valve ships closed and must be adjusted for proper performance.

Recommended Water Pressure Chart

Housing Size	Media Width (inches)	Water Pressure (in. wg)
XDG-10	26 <sup>3</sup> / <sub>4</sub>	19
XDG-20	66	74
XDG-30	84*	35
XDGX-12	30	20
XDGX-22	43 <sup>3</sup> / <sub>4</sub>	36
	60	61
XDGX-32	66	72
	96*	42
XDGX-35	120*	61
XDGX-38	180*	37
XDGX-42	216*	51

\*Multiple media sections. Values represent total media width.

#### NOTE

The recommended water pressure is based on media width. Refer to the table provided for proper water pressure settings.

### 3. Break-In Media

Leave the supply solenoid open to saturate and break-in media for 20 minutes with the blower off.

### 4. Close Solenoid

With the pressure set, press the Function key for one second to deactivate Flow Test Mode and allow the supply solenoid to close.

### 5. Check Media

Start the cooling cycle and check the media after one hour of operation. If the media is continuously dry or if too much water is draining from the sump tank, refer to Troubleshooting, Water Wizard™.

#### NOTE

Steps 6 through 8 are provided to adjust the minimum cooling temperature. The minimum cooling is preset to the factory recommended 75°F (24°C). Only adjust if needed.

#### NOTE

The inlet air sensor function overrides and shuts down the evaporative cooler if the outside temperature falls below the minimum cooling temperature.

### 6. Enter Program Mode

Press and hold the Enter key for three seconds. The display will read "Pro" when Program Mode is active.



Program Display

### 7. Adjust the Minimum Cooling Temperature

While in the Program Menu, use the Up and Down keys to navigate the Menu Options until "toF" is displayed. Press the Enter key to access the selected Menu Option setting.



Minimum Cooling Temperature Display

Use the Up and Down keys to adjust the Minimum Cooling Temperature as needed. Press the Enter key to save the Minimum Cooling Temperature setting and return to the Program Menu.

#### NOTE

The enter key must be pressed to save the new minimum cooling temperature.

### 8. Exit Program Mode

After ten seconds of idle time the controller will exit Program Mode.



### NOTE

The Freeze Temperature is preset to the factory recommended 45°F. Steps 9-11 should only be completed if the Freeze Temperature needs adjustment.

### NOTE

The Freeze Temperature is the temperature at which the supply solenoid closes and the drain solenoid opens to drain the supply line, preventing possible freeze damage. A drain solenoid is required for this option.

### 9. Enter Program Mode

Press and hold the Enter key for three seconds. The display will read "Pro" when Program Mode is active.



Program Display

### 10. Adjust the Freeze Temperature

While in Program Mode, use the Up and Down keys to navigate through the Menu Options until "Frt" is displayed. Press the Enter key to access the selected Menu Option setting.



Freeze Temperature Display

Use the Up and Down keys to adjust the Freeze Temperature setting as needed. Press the Enter key to set the Freeze Temperature and return to the Program Menu.

### NOTE

The enter key must be pressed to save the new freeze temperature.

### 11. Exit Program Mode

After ten seconds of idle time the controller will exit Program Mode.

## Operation - Water Wizard™ (optional)

**Drain Mode** locks open the drain solenoid and drains the supply line between the supply solenoid and the media. To activate Drain Mode simultaneously, press the Function and Enter keys (L2 will light). To deactivate Drain Mode and unlock the drain solenoid, simultaneously press the Function and Enter keys again.

**Flow Test Mode** - Activating Flow Test Mode opens the supply solenoid and allows water to pass to the manual supply valve. To activate Flow Test Mode, press and hold the Function key for one second (L3 will flash). To deactivate Flow Test Mode and allow the supply solenoid to close, press and hold the Function key again for one second.

### CAUTION

The sump drain line must be clear and draining to a safe location before using Flow Test Mode.

### CAUTION

Be aware of the water level in the sump tank at all times when using the Flow Test Mode.

**Program Mode** allows the user to view the Program Menu and edit the factory default settings. To access Program Mode and view the Program Menu, press and hold the Enter key for three seconds. While viewing the Program Menu, press the Up and Down keys to scroll through the Menu Options. To view the setting of the selected Menu Option, press the Enter key. To edit the setting, press the Up or Down key while viewing the setting. To save the setting and return to the Program Menu, press the Enter key. To return to the Program Menu without saving the change, wait 10 seconds. To exit Program Mode from the Program Menu, wait 10 seconds.

### WARNING

Changing the default settings will significantly affect performance. Only change a setting after reading and understanding this entire manual.

### WARNING

The Enter key must be pressed to save any changes made to a setting.

## Dry Bulb Temperature

The dry bulb temperature is visible on the home screen. If a number is not visible, wait 15 seconds and use the Up and Down keys until a number is displayed.

## Wet Bulb Temperature

To view the Wet Bulb Temperature, simultaneously press and hold the Up and Down keys.

## Indicating Lights

Three indicating lights are located across the top of the display to indicate the status of the Water Wizard™.

Light Status				
Indicating Light	On	Off	Blinking Long on, short off	Blinking Short on, long off
L1	Call for cooling	No call for cooling	Call for cooling. Outdoor temperature lockout.	N/A
L2	Drain solenoid open	Drain solenoid closed	N/A	Supply solenoid open. (Drain solenoid closed).
L3	Cooling on	Cooling off	Supply solenoid locked closed	Flow test mode active



## Check Operation - VAV Units (optional)

### NOTE

Blower Start-Up, Steps 1-5 should be performed before the blower is run.

### NOTE

For maintenance issues associated with variable frequency drives, consult the drive's manual supplied with the unit. The drives are programmed at the factory and should not need any adjustment during installation and start-up. For kitchen applications, the drive may be located in the kitchen or in the unit.

## Variable Volume Operation

The variable volume option is recommended when a building's exhaust volume may vary. This option enables the make-up air volume to track with the exhaust volume, providing only the amount of make-up air required. Control strategies include 2-speed VFD motors and modulating blowers. Before the unit is left in service, the variable volume control system should be tested.

### 2-Speed VFD Motor

A variable frequency drive (VFD) is used on a single speed motor to control air volumes. The VFD is factory programmed for 2 speed operation. It can be switched to low or high speed from a remote control panel. Turn the fan speed switch on the remote control panel to each position and confirm that the fan speed adjusts accordingly.

## Modulating

**Potentiometer Control** - a variable frequency drive is controlled by input from a remote speed selector (potentiometer). This unit allows easy manual adjustment of make-up air volumes. To test potentiometer operation, turn the potentiometer to the two extremes. With variable volume, make sure the fan goes to maximum and minimum speed.

When the potentiometer is at 0, the fan speed will be at its minimum. When the potentiometer is at 100, the fan will be at its maximum speed.

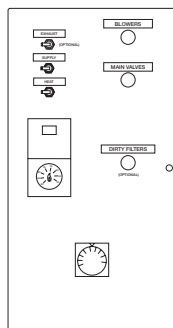

Potentiometer Control

## Building Pressure Control

- a variable frequency drive is controlled according to input from a pressure sensing device.

Turn both knobs to the upper most pressure setting. You may have to remove the outdoor pressure tap tubing. VAV systems should go to maximum speed. Set both knobs at the lowest setting and the VAV systems should go to minimum speed.

Reset the correct pressure limits before starting the unit.

This picture depicts a typical photohelic setting. Typical settings are 0.0 inch wc for the lower pressure setting and 0.10 inch wc for the upper pressure setting. The needle indicates a negative building pressure. During correct operation, the indicating needle will remain between or near the setting needles.

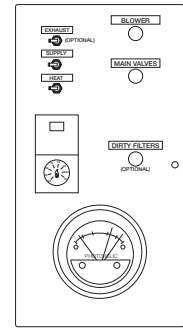

Building Pressure Control

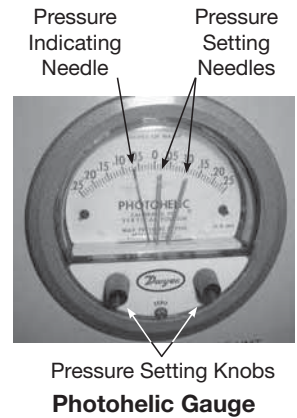

Pressure Setting Knobs  
Photohelic Gauge

**External Signal** - a variable frequency drive is controlled according to input from an external 2-10 VDC or 4-20 mA signal (by others).

A 2 VDC or 4 mA signal will send the blower to low speed. The blower will go to maximum speed with a 10 VDC or 20 mA signal.

**Variable Kitchen Control** - a variable frequency drive is controlled by input from a remote speed control. This unit allows automatic adjustment of make-up air volumes based on varying cooking loads.

## Burner Bypass Damper (optional)

The self-adjusting burner bypass damper is a device used in variable volume units. Its function is to maintain proper combustion by providing a constant airflow over the burner when outside air volumes are changed.

It is located underneath the burner as shown.

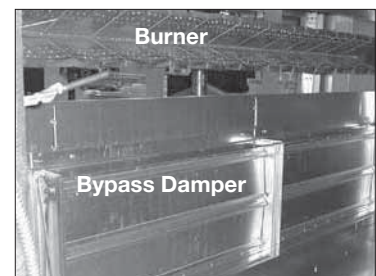

Burner Bypass Damper

## WARNING

The burner bypass damper is set-up at the factory. The weights should not be adjusted in the field. The damper may not fully close during minimum outside air mode.





## Check Operation - Recirculating Units (optional)

### NOTE

Blower Start-Up, steps 1-5 should be performed before the blower is run.

## Recirculation Operation

The recirculation operation option is recommended when the ventilation equipment provides the primary source of heating for the space. A minimum of 20% outdoor air is mixed with up to 80% filtered recirculated air. Control strategies include 2-position and modulating dampers.

Before the unit is left in service, the recirculation control system should be tested.

## 2-Position Damper

A 2-position spring return actuator is used to control the return air amounts. The damper moves from open to closed. If power is cut to the unit, the outdoor air damper will fail to close.

Turn the recirculating switch on the remote control panel to each position and confirm that the return air damper adjusts accordingly. The damper actuator may take a few minutes to open or close.

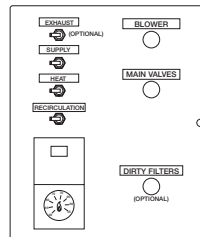

2-Position Damper Control

## Modulating

**Potentiometer Control** - a modulating spring return actuator is used to control the return air amounts. The return air damper modulates from fully open to fully closed based on a signal from a remote potentiometer.

To test potentiometer operation, turn the potentiometer to the two extremes. With 80/20 recirculation, confirm that the return air damper fully opens and fully closes. When the potentiometer is at 0, the return air damper will open. When the potentiometer is at 100, the return air damper will close. The damper actuator may take a few minutes to open or close.

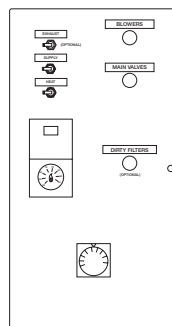

Potentiometer Control

**Building Pressure Control** - a modulating spring return actuator is used to control the return air amounts. The return air damper modulates from fully open to fully closed based on a signal from a remote pressure sensing device.

Turn both knobs to the upper most pressure setting. You may have to remove the outdoor pressure tap tubing. The return air damper should close.

Set both knobs at the lowest setting and the damper should open. It may take one to two minutes for the damper to reach the desired position.

Reset the correct pressure limits before starting the unit.

This picture shows a typical photohelic setting. Typical settings are 0.0 inch wc for the lower and 0.10 inch wc for the upper pressure setting. The needle in this photo indicates a negative building pressure. During correct operation, the indicating needle will remain between or near the setting needles.

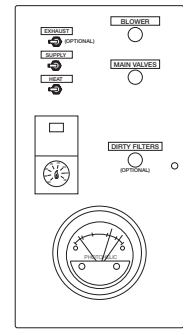

Building Pressure Control

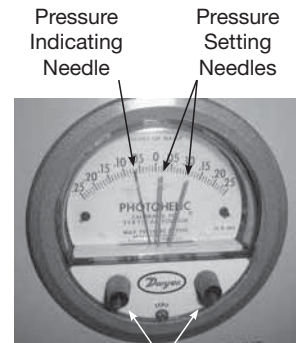

Pressure Setting Knobs

Photohelic Gauge

**External Signal** - a modulating spring return actuator is used to control the return air amounts. Return air damper modulates from fully open to fully closed based on an external 2-10 VDC or 4-20 mA signal (by others).

The return air damper will close with a 10 VDC or 20 mA signal. The return air damper should open with a 2 VDC or 4mA signal. The damper actuator may take a few minutes to open or close.



## Operation - Electrical

### Electrical Sequence

#### 1. Exhaust Fan Contact (S1) Closed (optional)

- Power passes to N.C. exhaust overload contact (ST2 OL) (optional)
- Power passes to exhaust starter(s) ST2
- N.O. exhaust starter switches are energized and closed
- Power passes to exhaust fans
- Exhaust fan(s) (M2) start

#### 2. Supply Fan Contact (S2) Closed

- Power passes through N.C. field-supplied fire contact (FSC)
- Power passes through N.O. exhaust fan contact (ST2), which is closed when the exhaust relay (ST2) is activated (optional)
- Power passes to N.C. supply overload contact (ST1 OL)
- Power passes through N.C. contact on optional freeze protection timer (RT4) which remains closed if the temperature has remained above the set point
- Power passes to optional inlet damper which opens
- When damper is fully opened, damper relay (D1) is energized and optional N.O. damper limit switch (DL1) closes
- Power passes to and energizes supply starter relay (RF)
- Power passes to N.O. fan contact (RF), which is energized and closed
- Supply starter (ST1) is energized
- Supply starter contact (ST1) closes and power reaches and energizes supply fan
- Supply fan (M1) starts

#### 3. Heat Contact (S4) Closed

- Power passes to N.O. fan relay (RF) which is energized and closed
- Power passes to optional inlet air sensor contact (TS4) which is energized and closed if the inlet air temperature is below the set point
- Power passes to and energizes the heat relay (RH)
- N.O. heat relay contact (RH) closes
- Power passes to N.C. high limit control contact (HLC1) which is closed if temperature has remained below set point
- Power passes to optional N.O. and N.C. high and low gas pressure contacts (PS4 and PS3), which are both closed if gas pressure is within the set range
- Power passes to N.O. and N.C. airflow switches (PS2) which are closed if there is proper airflow across the burner

- Power passes to terminal TH on the Flame Safeguard (FSG) which begins it's sequence (see Direct Gas Burner Sequence)

#### 4. Optional Evaporative Cooling Contact (S4) Closed\*

- N.O. contact on fan relay (RF) is energized and closed
- Power passes to optional inlet air sensor contact (TS4) which is energized and closed if the inlet air temperature is above the set point
- Power passes to and energizes cool relay (RC)
- N.O. contact on cool relay (RC) is energized and closed
- Power passes to optional evaporative cooling pump (P1)

\*If DX or chilled water coils are used rather than an evaporative cooler, the cooling sequence of operation will depend on the coil controls. Cooling coil controls are supplied by others.

### Direct Gas Burner Sequence

#### 1. Supply Fan Contact Closed

- Power passes to the supply fan and heat switch

#### 2. Heat Contact Closed

- Power passes to the heat relay then to the Flame Safeguard

#### 3. Flame Safeguard (FSG) Sequence

- Checks for proper airflow
- Verifies no flame present at burner
- Initiates 15 second prepurge
- Sends power to open gas valve (V2) and energizes the spark generator
- Tries for up to 10 seconds to light and confirm flame
- Shuts down spark generator
- Continuously monitors the flame and airflow



# Troubleshooting

## Blower Does Not Operate

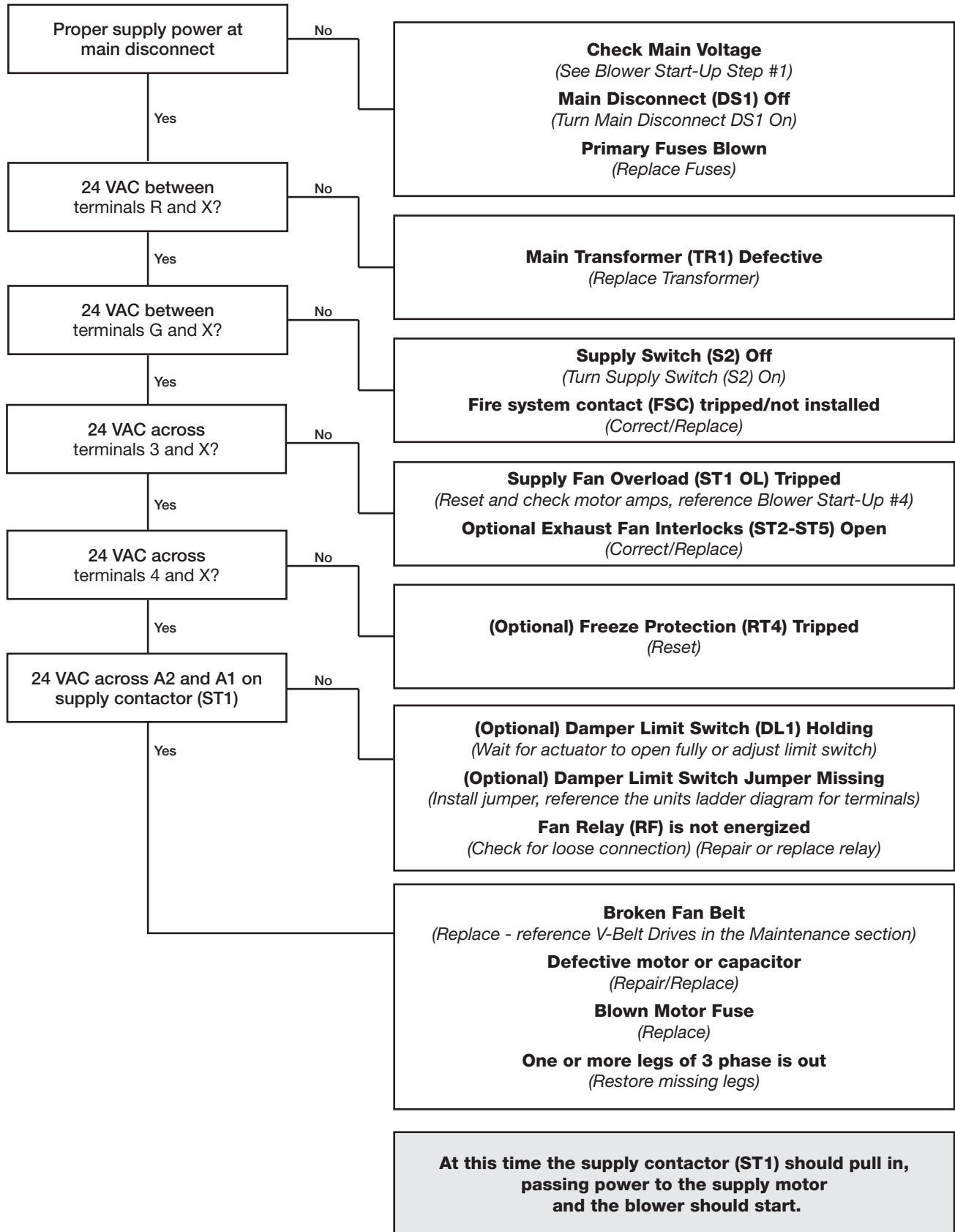

# Troubleshooting

## Motor Overamps

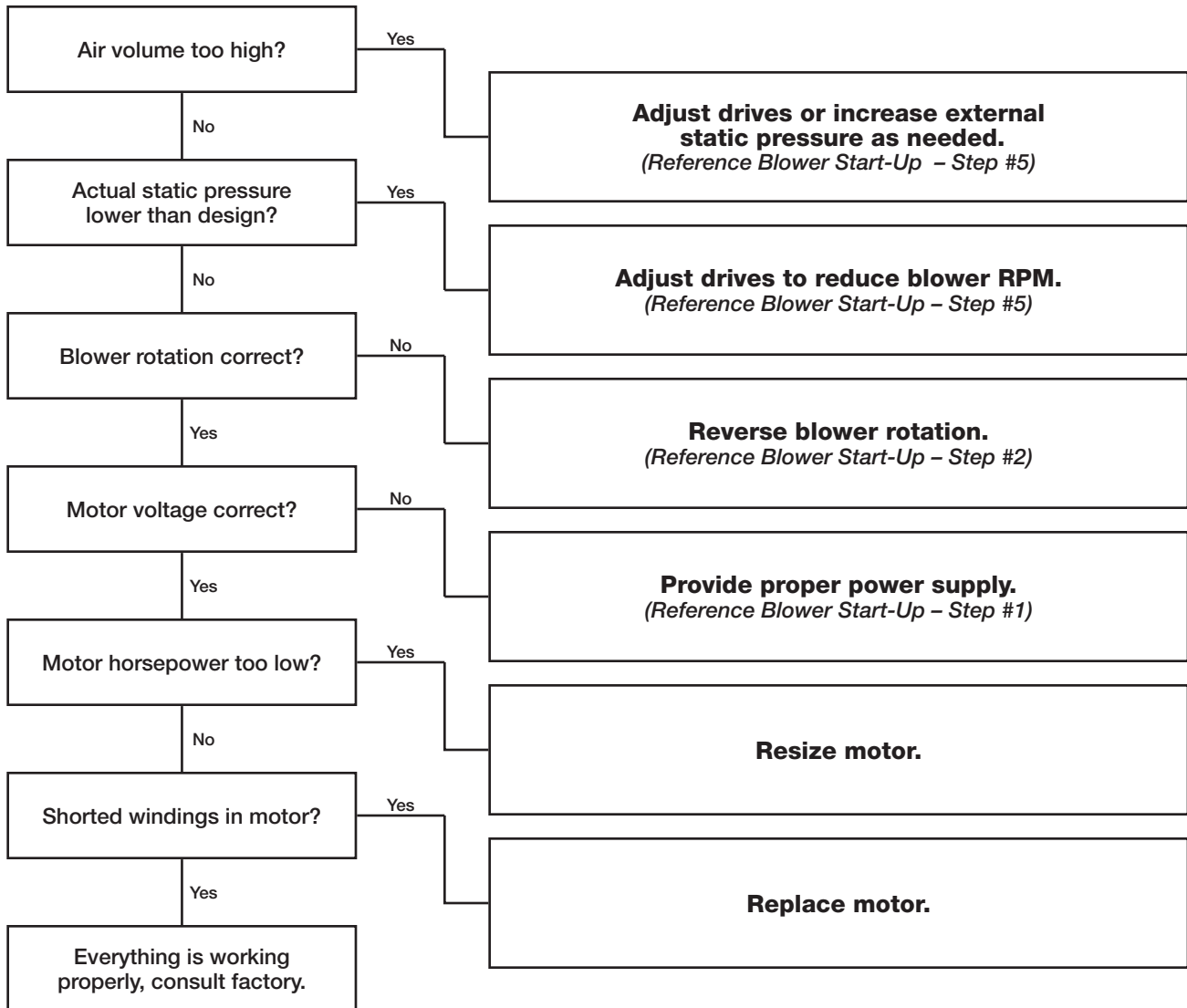

# Troubleshooting

## Insufficient Airflow

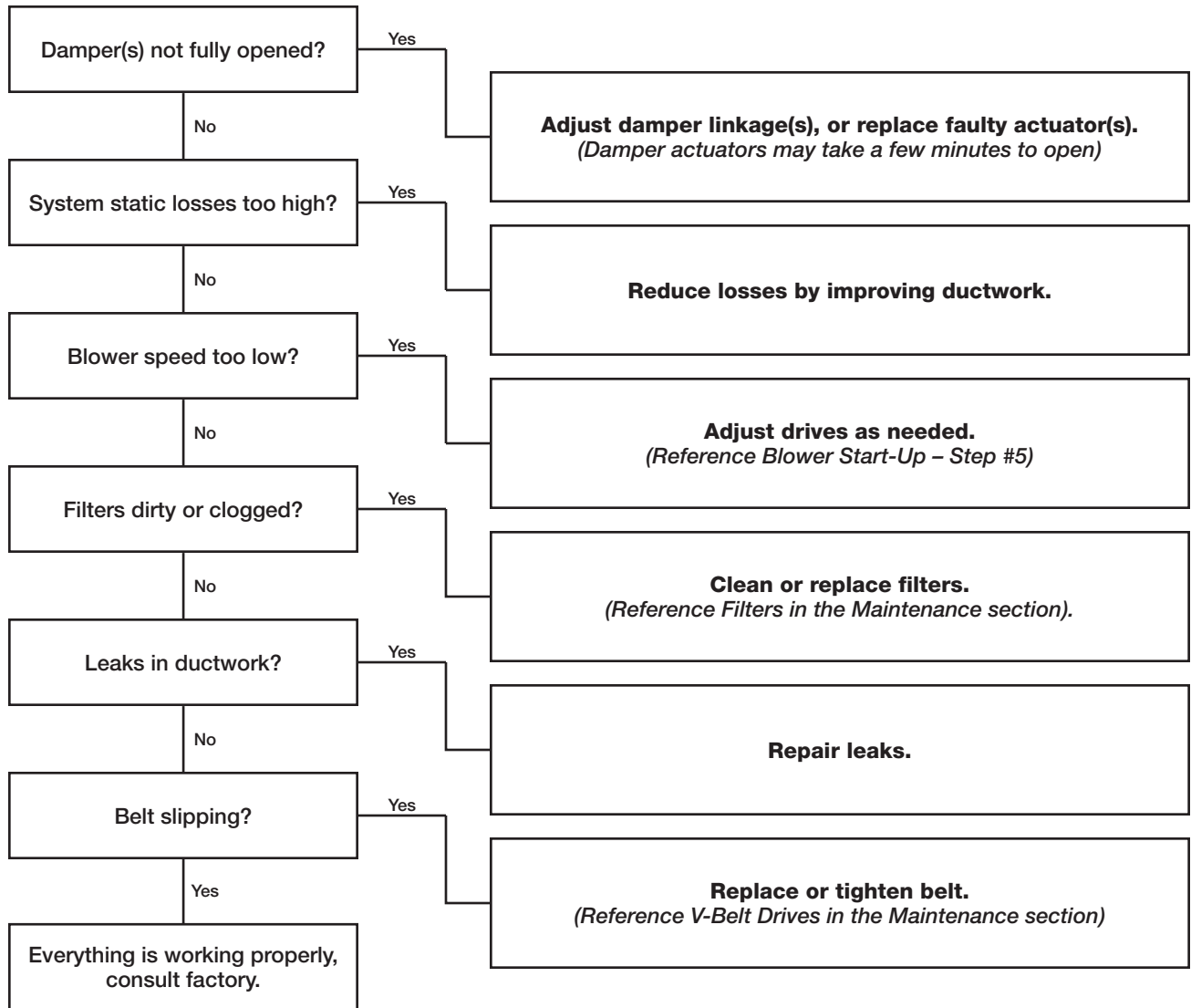

## Too Much Airflow

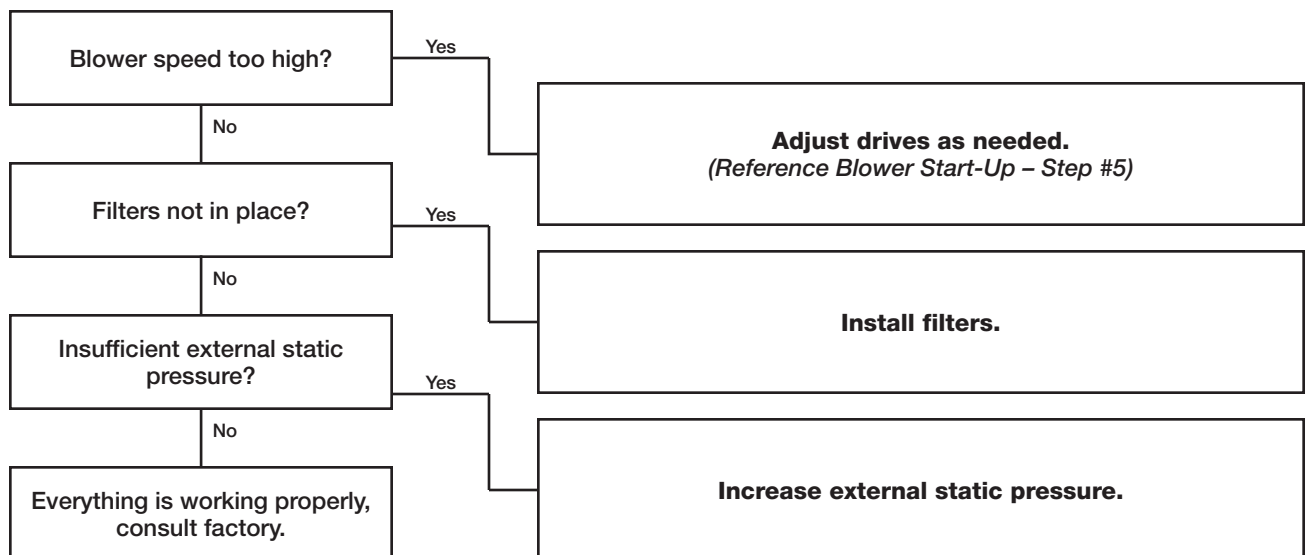

# Troubleshooting

## Excessive Noise or Vibration

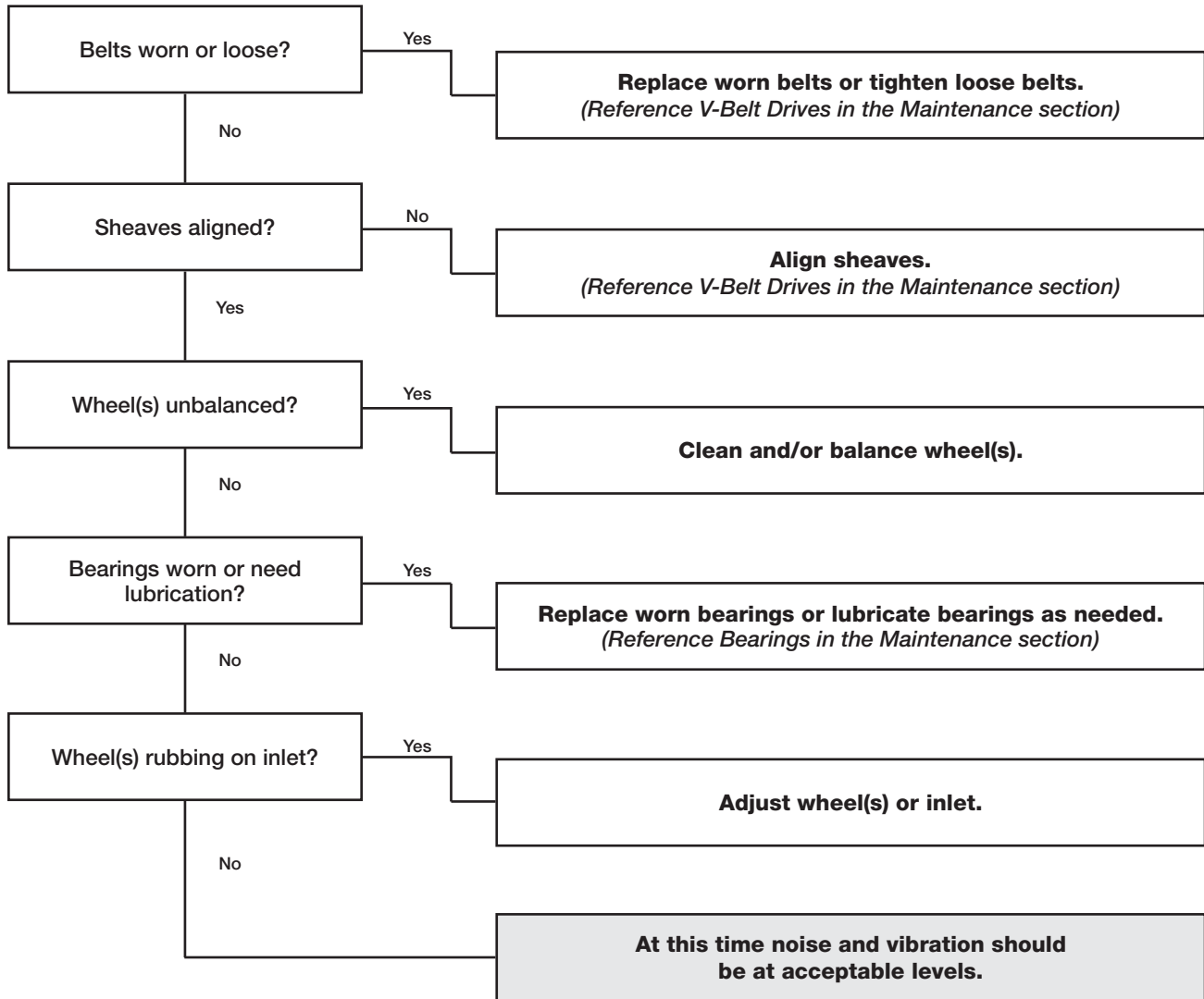



# Troubleshooting

## Heater Does Not Operate

Does not attempt to light (No visible spark)

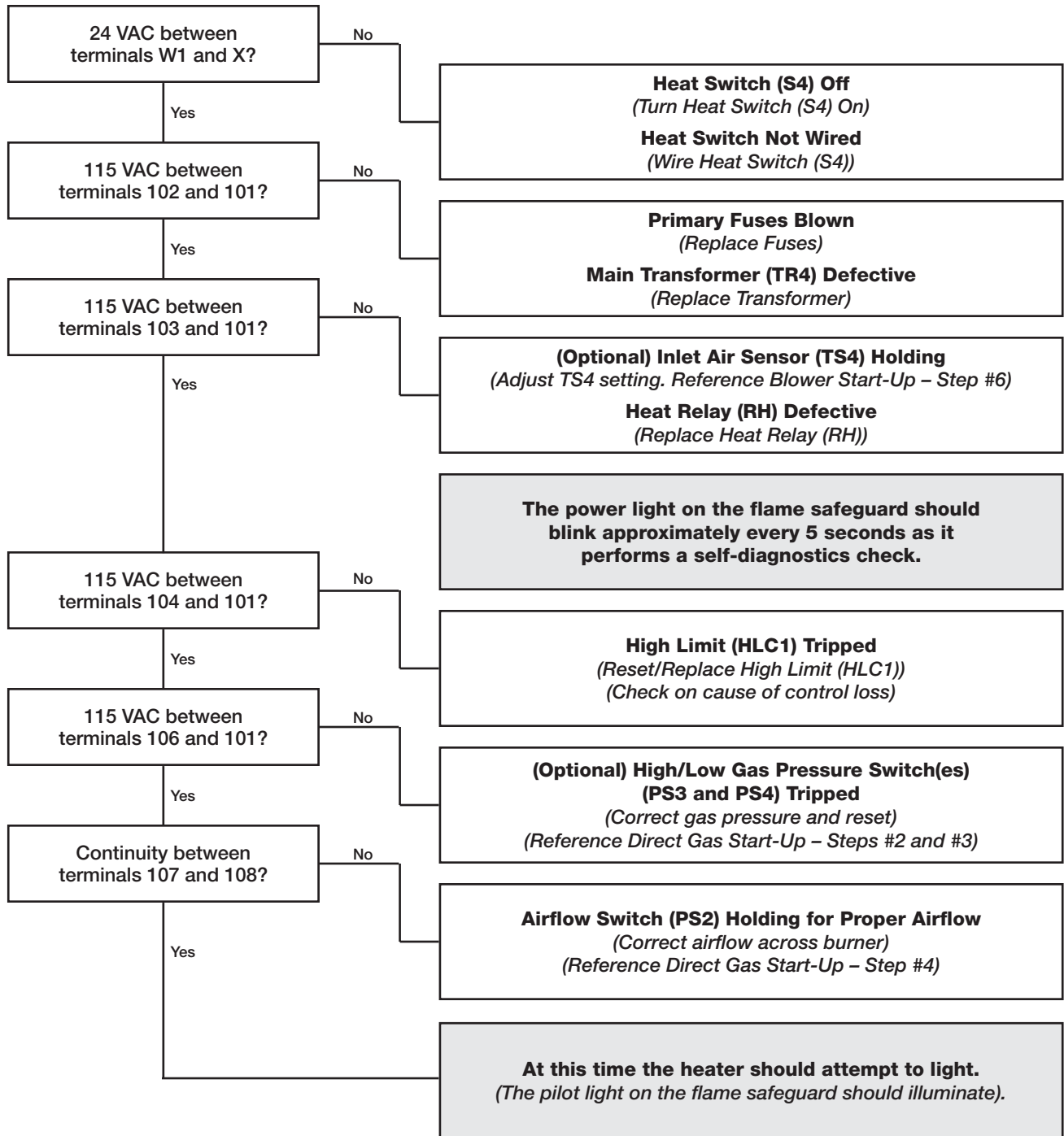

# Troubleshooting

## Heater Does Not Operate

Attempts to light, but no flame (Visible spark)

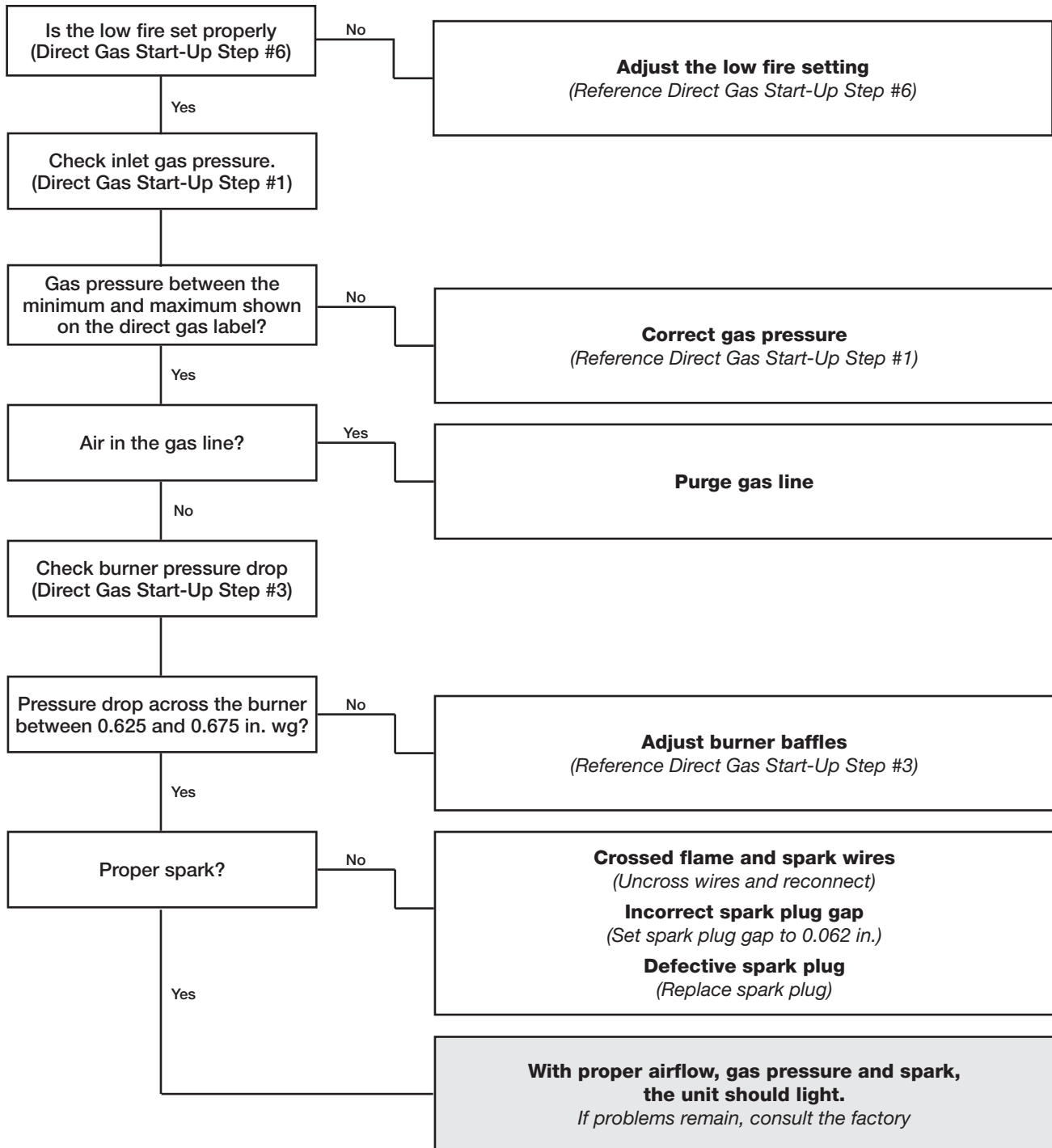

# Troubleshooting

## Evaporative Cooler does not Operate (Recirculating pump)

Supply fan must be on for cooler to operate

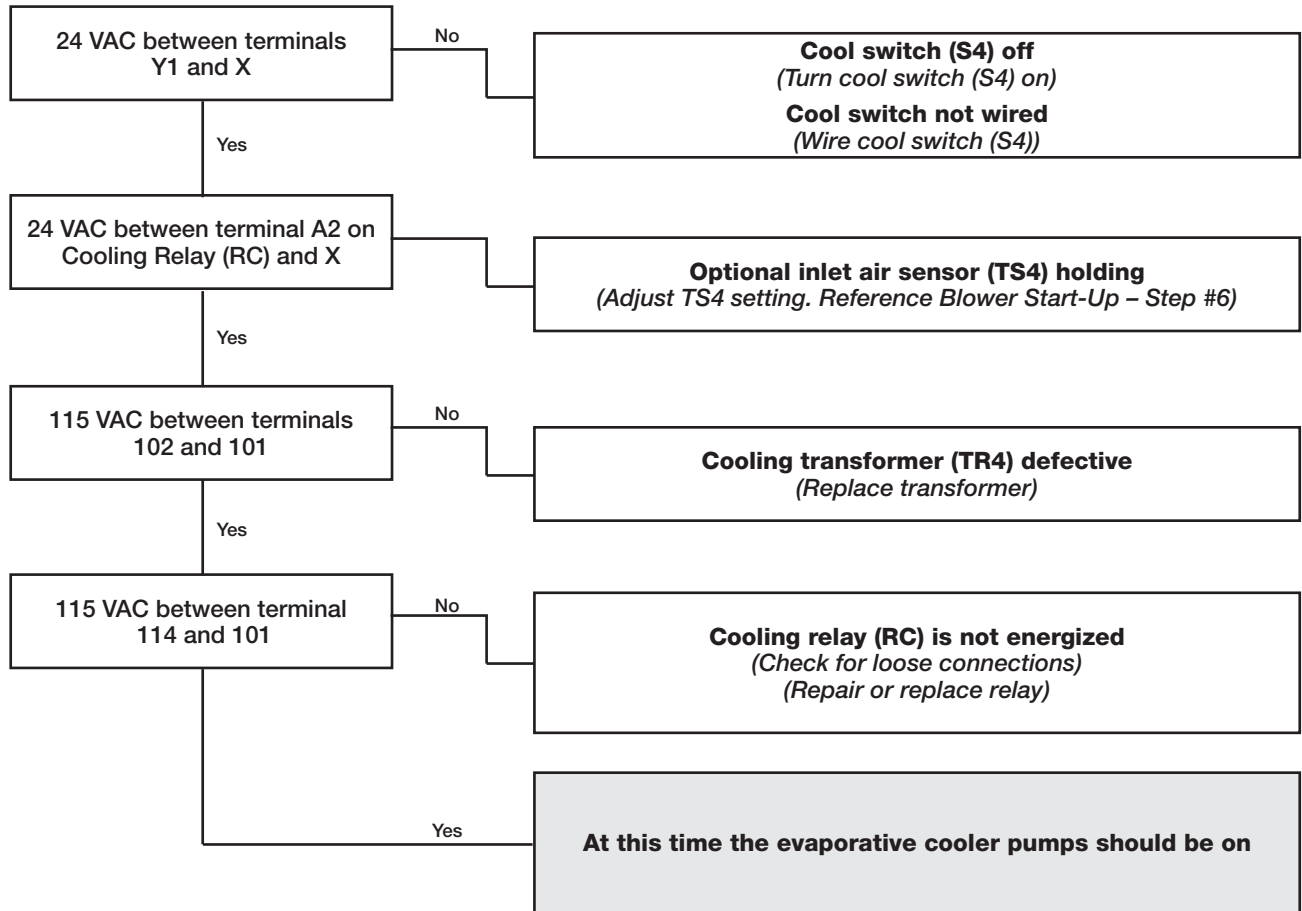

## Water Blows through Evaporative Cooler

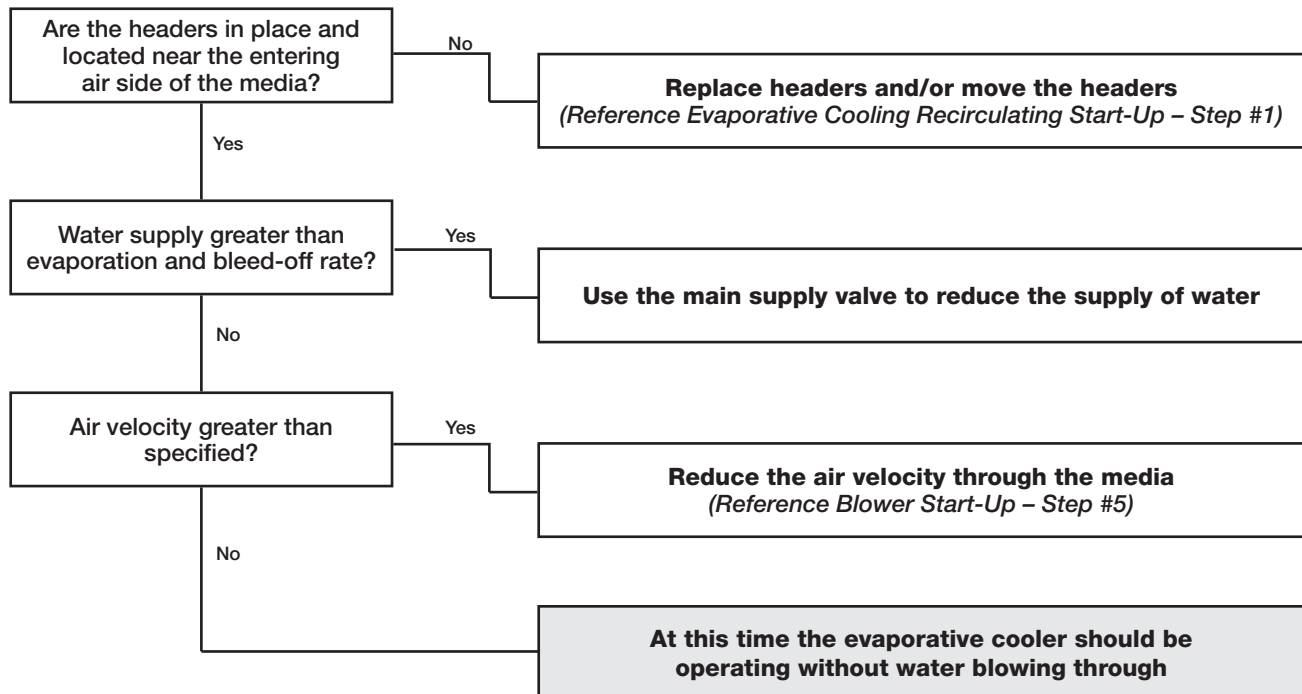

# Troubleshooting

## Water Wizard™ – Improper Water Supply

### NOTE

If the water supply is too low, the media will continuously appear dry.

### NOTE

If the water supply is too high, the media will be saturated and excessive water will be draining from the sump tank.

### NOTE

Some water drainage is desired to keep the media flushed, but it should be minimized to utilize the Water Wizard.

### 1. Adjust the Manual Supply Valve

Adjust the manual supply valve (refer to Start-Up, Water Wizard™). If the recommended water pressure does not provide enough water, increase the pressure until the desired water supply is achieved. If the recommended water pressure provides too much water, decrease the water pressure until the desired water supply is achieved.

### CAUTION

Only proceed to Steps 2 and 3 if Step 1 does not correct the problem.

### 2. Enter Program Mode

Press and hold the Enter key for three seconds to enter Program Mode. The display will read “Pro” when Program Mode is active.



Program Display

### 3. Adjust the On Time Factor

While in the Program Menu, use the Up and Down keys to navigate through the menu options until “ont” is displayed.



On Time Factor Display

With “ont” displayed, press the Enter key to access the setting.

With the setting displayed, use the Up and Down keys to adjust the setting as needed.

Increase the factor to increase the water supply or decrease the factor to decrease the water supply.

Press the Enter key to save the new On Time Factor and return to the Program Menu.

### NOTE

Changing the On Time Factor by (1) will change the water supply by approximately 3%.

### IMPORTANT

The Enter key must be pressed to save the new On Time Factor.

### 4. Exit Program Mode

After 15 seconds of idle time the controller will automatically exit Program Mode



## Maintenance - Routine

### CAUTION

Lock-out the gas and the electrical power to the unit before performing any maintenance or service operations to this unit.

### V-Belt Drives

V-belt drives must be checked on a regular basis for wear, tension, alignment, and dirt accumulation.

Check the tension by measuring the deflection in the belt as shown below.

Check the alignment by using a straight edge across both sheaves as shown below.

### IMPORTANT

Premature or frequent belt failures can be caused by improper belt tension, or misaligned sheaves.

- Abnormally high belt tension or drive misalignment will cause excessive bearing loads and may result in failure of the fan and/or motor bearings.
- Abnormally low belt tension will cause squealing on start-up, excessive belt flutter, slippage, and overheated sheaves.

### IMPORTANT

Do not pry belts on or off the sheave. Loosen belt tension until belts can be removed by simply lifting the belts off the sheaves.

### IMPORTANT

When replacing V-belts on multiple groove drives, all belts should be changed to provide uniform drive loading.

### IMPORTANT

Do not install new belts on worn sheaves. If the sheaves have grooves worn in them, they must be replaced before new belts are installed.

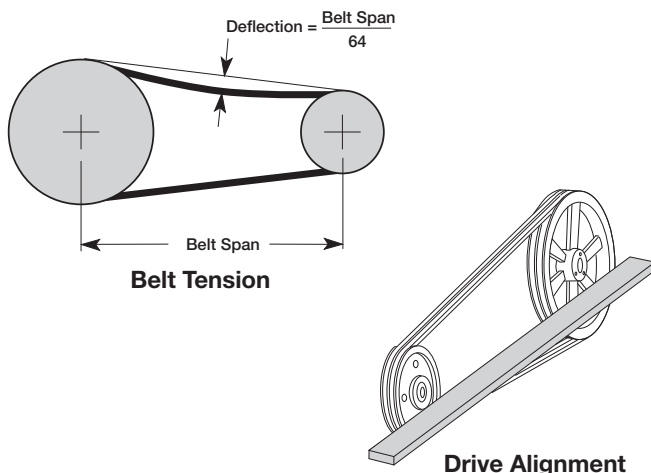

### Snow Accumulation

Clear snow away from roof mounted units. Keep the snow clear of the intake and access doors.

### Wheels

Wheels require little attention when moving clean air. Occasionally oil and dust may accumulate on the wheel causing imbalance. When this occurs, the wheel and housing should be cleaned to assure proper operation.

### Bearings

The bearings for our fans are carefully selected to match the maximum load and operating conditions of the specific class, arrangement and fan size. The instructions provided in this manual and those provided by the bearing manufacturer will minimize any bearing problems.

### IMPORTANT

Lubricate bearings prior to periods of extended shutdowns or storage and rotate shaft monthly to aid in corrosion prevention. If the fan is stored more than three months, purge the bearings with new grease prior to start-up.

### Recommended Bearing Lubrication Schedule (in months\*)

Fan RPM	Bearing Bore Size (inches)				
	½ - 1	1½ - 1½	1⅝ - 1⅞	1 <sup>15</sup> / <sub>16</sub> - 2 <sup>3</sup> / <sub>16</sub>	2 <sup>7</sup> / <sub>16</sub> - 3
250	6	6	6	6	6
500	6	6	6	5	4
750	6	5	4	3	3
1000	5	3	2	1	1
1250	5	3	2	1	1
1500	5	2	1	1	0.5
2000	5	1	1	0.5	0.25

\*Suggested initial greasing interval is based on 12 hour per day operation and 150°F maximum housing temperature. For continuous (24 hour) operation, decrease greasing interval by 50%

- If extended grease lines are present, relubricate while in operation, only without endangering personnel.
- For ball bearings (operating) relubricate until clean grease is seen purging at the seals. Be sure not to unseat the seal by over lubricating.
- For ball bearings (idle) add 1-2 shots of grease up to 2 inch bore size, and 4-5 shots above 2 inch bore sizes with a hand grease gun.
- For roller bearings add 4 shots of grease up to 2 inch bore size, and 8 shots for 2-5 inch bore size with a hand grease gun.
- Adjust relubrication frequency based on condition of purged grease.
- A high quality lithium based grease conforming to NLGI Grade 2 consistency, such as those listed here:
 

Mobil 532	Texaco Multifak #2	B Shell Alavania #2
Mobilux #2	Texaco Premium #2	Exxon Unirex #2





## Motors

Motor maintenance is generally limited to cleaning and lubrication (where applicable).

Cleaning should be limited to exterior surfaces only. Removing dust and grease build-up on the motor assures proper motor cooling.

Motors supplied with grease fittings should be greased in accordance with the manufacturer's recommendations.

### IMPORTANT

Do not allow water or solvents to enter the motor or bearings. Motors and bearings should never be sprayed with steam, water or solvents.

### IMPORTANT

Greasing motors is only intended when fittings are provided. Many motors are permanently lubricated, requiring no additional lubrication.

## Filters

Filter maintenance is generally limited to cleaning and replacement.

If aluminum mesh filters are installed, they can be washed in warm soapy water.

An adhesive spray can be added to aluminum mesh filters to increase their efficiency.

If disposable filters are installed, they can be checked by holding up to a light source. If light cannot pass through the filter, it should be replaced.

### IMPORTANT

When reinstalling filters, be sure to install them with the airflow in the correct direction. An airflow direction arrow is located on the side of the filters.

### IMPORTANT

Replacement filters should be from the same manufacturer and the same size as the original filters provided with the unit.

## Chilled Water Coils

Test the circulating fluid for sediment, corrosive products and biological contaminants. Make the necessary corrective measures.

Maintain adequate fluid velocities and proper filtering of the fluid.

If automatic air vents are not utilized, periodic venting of the coil is recommended to remove accumulated air.

## Evaporative Coolers

The media should be periodically brushed lightly with a soft bristle brush in an up and down motion while flushing with water. This aids in reducing the amount of mineral build-up.

For large amounts of mineral build-up, clean or replace the media and increase the water bleed-off or flush rate.

The cooling media has a useful life of 3 to 5 years depending on the water quality and the bleed-off or flush rate.

### IMPORTANT

When reinstalling the evaporative media, make sure that it is installed correctly. Reference the drawing shown below.

### IMPORTANT

Replacement media should be from the same manufacturer and be the same size as the original media provided with the unit.

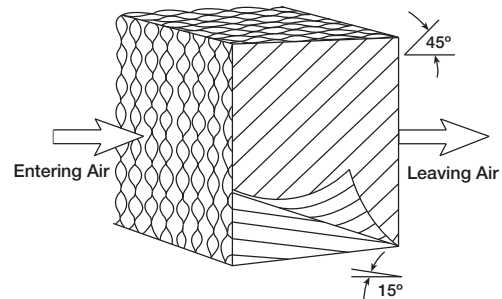

Media Orientation

## Cooling Coils

### WARNING

Repair and replacement of the coil and the connecting piping, valves, etc., should be performed by a qualified individual.

Inspect the coil for signs of corrosion and/or leaks. Repair any leaks as required.

Inspect the coil's surface for foreign material. If the coil surface needs cleaning, clean the coil from the leaving air-side so that foreign material will be washed out of the coil rather than pushed farther in.

Inspect and clean the drain pan to prevent the growth of algae and other organisms.

### IMPORTANT

Be sure to read and follow the manufacturer's recommendations before using any cleaning fluid.

### CAUTION

Caution should be used to avoid injury when venting the coil. High pressure and/or high temperature fluids can cause serious injuries.



## Maintenance - Fall

### Start-Up

Repeat the Blower Start-Up Step #5 and Direct Gas Start-Up Steps #1, #2 and #3. This will ensure that the gas and air are set properly before the heating season begins and should lead to trouble free operation all winter.

### High Limit

The high limit switch may have tripped over the summer; it should be checked and reset if necessary.

### Burner

Inspect the burner for accumulation of scales on both the upstream and downstream sides of the mixing plates. Any scaling or foreign material should be removed with a wire brush.

Visually check that all holes in the mixing plates are clear. If any burner ports are plugged (even partially), clear them with a piece of wire or another appropriate tool.

Replace or tighten any loose or missing fasteners on the mixing plates. Always use zinc plated or stainless steel fasteners.

Inspect and clean the flame and spark rod. Occasional replacement of the flame rod and spark rod may be necessary to ensure optimum unit performance.

#### WARNING

Do not enlarge burner ports when clearing a blockage, performance could be affected.

#### NOTE

Flame rods can last many years, but because of thermal expansion of the porcelain, flame rods can fail over time.

### Gas Train

The gas connections, joints and valves should be checked annually for tightness. Apply a soap and water solution to all piping; watch for bubbling which indicates a leak. Other leak testing methods can be used.

### Evaporative Coolers

The water should be shut off and all the lines drained when the outside temperature drops below 45°F.

Remove drain plugs for the winter.

Clean all interior parts of any mineral deposits or foreign materials that may have built-up during the cooling season.

Replace any worn or non-functioning parts.

### Winterizing Chilled Water Coils

During the winter, chilled water coils need to be protected against freezing. Manufacturer recommends protecting the coils by either blowing-out the coils or by flushing the coils.

#### Blowing-Out Coils

1. Close valves on the supply and return lines.
2. Open drain valves and/or drain plug. Remove vent plug to allow coil to drain faster.
3. After coil is fully drained, connect a blower to the caps. Do not connect the blower to the air vent or drain plug.
4. Close the vent plug on the header that the blower is connected to. Open the drain valve or cap on the other header.
5. Turn on blower for 30 minutes. Place mirror at discharge. If the mirror fogs up, repeat procedure until no fog appears on the mirror.
6. After drying the coil, wait a few minutes then repeat Step #5.
7. Leave drains open and do not install plugs until beginning of cooling season.

#### Flushing Coils

Manufacturer recommends the use of inhibited glycol (such as propylene or ethylene) to flush water coils to protect against freezing. Additionally, the use of inhibited glycol provides corrosion protection.

The table below indicates the percentage of glycol required to prevent freezing in a coil at a given outdoor air freeze point. Completely fill coil with solution. Drain coil. Residual glycol fluid per these concentrations can be left in the coil without concern of freezing. Recovered fluid can be used to flush other coils.

Percent of Ethylene Glycol by Volume	Freeze Point		Percent of Propylene Glycol by Volume	Freeze Point	
	°F	°C		°F	°C
0	32	0	0	32	0
10	25	-4	10	26	-3
20	16	-9	20	19	-7
30	3	-16	30	8	-13
40	-13	-25	40	-7	-22
50	-34	-37	50	-28	-33
60	-55	-48	60	-60	-51



## Reference

### Typical Gas Train Layout with Direct Spark Ignition

This is a typical gas train. The gas train in your unit may be different.

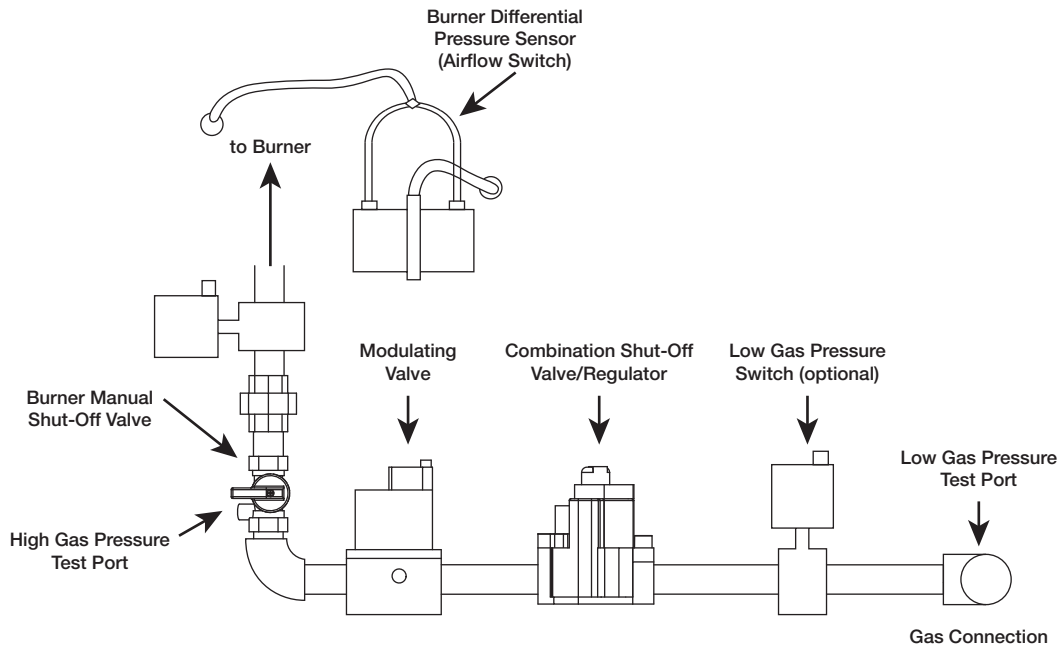

**Direct Spark Ignition Gas Train**



## Reference

### Control Center Layout

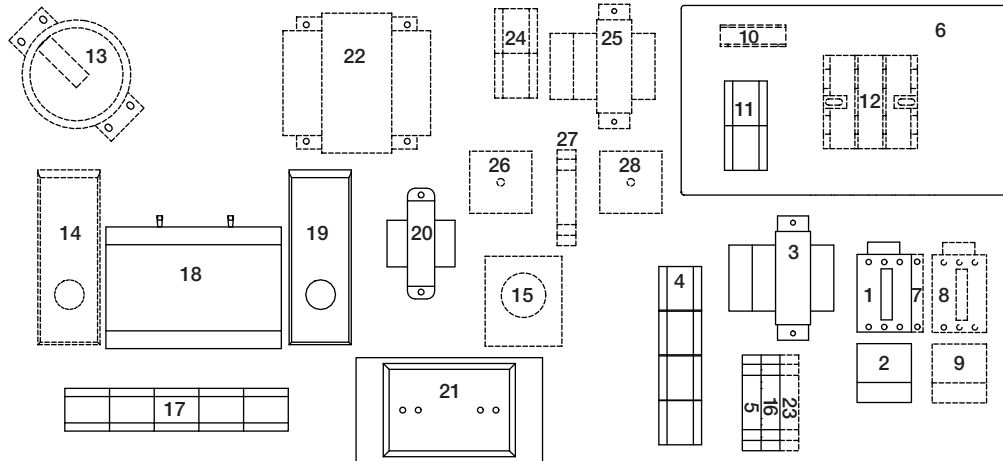

1. Supply Motor Starter — 24 volt magnetic contacts for starting supply motor.
2. Supply Overload — provides electronic overload protection to supply motor.
3. Low Voltage Transformer — provides low voltage to fan/heat/cooling enable controls.
4. Control Terminal Block — provides wiring access to controls.
5. Fan Relay — allows power to pass to energize motor starter.
6. High Voltage Enclosure — provides protection from high voltage circuits.
7. Auxiliary Contact (optional) — provides one normally closed and one normally open contact for other equipment.
8. Exhaust Motor Starter (optional) — 24 volt magnetic contacts for starting exhaust motor.
9. Exhaust Overload (optional) — provides electronic overload protection to exhaust motor.
10. Transformer Fuse (optional) — provides proper fusing for cooling transformer.
11. Terminal Block — provides wiring access to high voltage circuits.
12. Exhaust Fuses (optional) — provides proper fusing for exhaust fan motor(s).
13. Dirty Filter Switch (optional) — monitors filter pressure drop, turns on indicating light when pressure drop is above field-adjustable set point.
14. Inlet Air Sensor (optional) — outdoor air stat that automatically controls the heating and/or cooling based on outdoor air temperature.
15. Remote Temperature Selector (optional) — allows for remote temperature set point.
16. Heat Relay — allows power to pass to heating controls.
17. Heating Terminal Block — provides wiring access to heating controls.
18. Flame Safeguard/Spark Generator — monitors flame, shuts down unit when unsafe conditions are detected.
19. High Limit — prevents unit from discharging air above a set point.
20. Low Voltage Transformer — reduces voltage to Maxitrol system.
21. Amplifier — controls modulating valve, assures the desired temperature is delivered.
22. Transformer (optional) — provides voltage to optional evaporative cooling pump.
23. Cooling Relay (optional) — allows power to pass to cooling controls.
24. Cooling Terminal Block (optional) — provides wiring access to cooling controls.
25. Low Voltage Transformer (optional) — reduces voltage to cooling controls.
26. Reset Timer (optional) — resets cooling system to run a time interval.
27. Auto Drain Relay (optional) — assures supply pump does not operate during drain interval. Allows pump to operate in cooling mode.
28. Cooling Timer (optional) — allows for automatic draining of the evaporative cooling system based on time schedule.







# Maintenance Log

Date \_\_\_\_\_ Time \_\_\_\_\_ AM/PM  
Notes: \_\_\_\_\_  
\_\_\_\_\_  
\_\_\_\_\_  
\_\_\_\_\_

Date \_\_\_\_\_ Time \_\_\_\_\_ AM/PM  
Notes: \_\_\_\_\_  
\_\_\_\_\_  
\_\_\_\_\_  
\_\_\_\_\_

Date \_\_\_\_\_ Time \_\_\_\_\_ AM/PM  
Notes: \_\_\_\_\_  
\_\_\_\_\_  
\_\_\_\_\_  
\_\_\_\_\_

Date \_\_\_\_\_ Time \_\_\_\_\_ AM/PM  
Notes: \_\_\_\_\_  
\_\_\_\_\_  
\_\_\_\_\_  
\_\_\_\_\_

Date \_\_\_\_\_ Time \_\_\_\_\_ AM/PM  
Notes: \_\_\_\_\_  
\_\_\_\_\_  
\_\_\_\_\_  
\_\_\_\_\_

Date \_\_\_\_\_ Time \_\_\_\_\_ AM/PM  
Notes: \_\_\_\_\_  
\_\_\_\_\_  
\_\_\_\_\_  
\_\_\_\_\_

Date \_\_\_\_\_ Time \_\_\_\_\_ AM/PM  
Notes: \_\_\_\_\_  
\_\_\_\_\_  
\_\_\_\_\_  
\_\_\_\_\_

Date \_\_\_\_\_ Time \_\_\_\_\_ AM/PM  
Notes: \_\_\_\_\_  
\_\_\_\_\_  
\_\_\_\_\_  
\_\_\_\_\_

Date \_\_\_\_\_ Time \_\_\_\_\_ AM/PM  
Notes: \_\_\_\_\_  
\_\_\_\_\_  
\_\_\_\_\_  
\_\_\_\_\_

Date \_\_\_\_\_ Time \_\_\_\_\_ AM/PM  
Notes: \_\_\_\_\_  
\_\_\_\_\_  
\_\_\_\_\_  
\_\_\_\_\_

Date \_\_\_\_\_ Time \_\_\_\_\_ AM/PM  
Notes: \_\_\_\_\_  
\_\_\_\_\_  
\_\_\_\_\_  
\_\_\_\_\_

Date \_\_\_\_\_ Time \_\_\_\_\_ AM/PM  
Notes: \_\_\_\_\_  
\_\_\_\_\_  
\_\_\_\_\_  
\_\_\_\_\_



## Our Commitment

---

*As a result of our commitment to continuous improvement, Accurex reserves the right to change specifications without notice.*

Specific Accurex product warranties are located on [accurex.com](http://accurex.com) within the product area tabs and in the Library under Warranties.



P.O. Box 410 Schofield, WI 54476  
Phone: 800.333.1400 • Fax: 715.241.6191  
Parts: 800.355.5354 • [www.accurex.com](http://www.accurex.com)